

**TECHNICAL SPECIFICATION**

**COLOURS**

**PARTITION WALLS - FABRICS ELEMENTS - FABRIC NEMO**

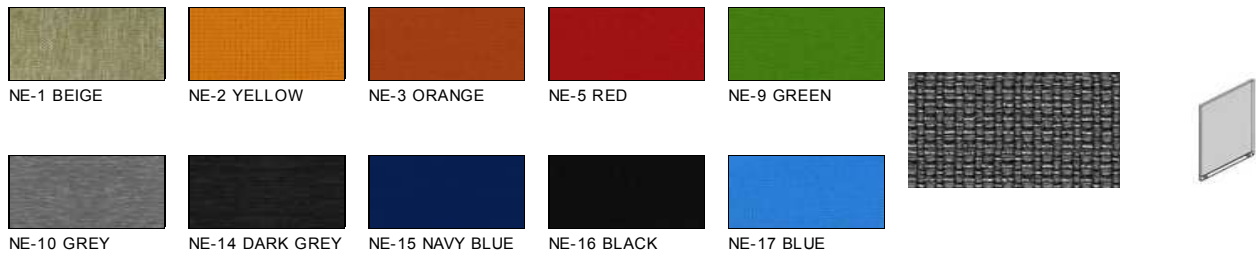

**FABRIC PANEL SONIC, VIVA - FABRIC NEMO**

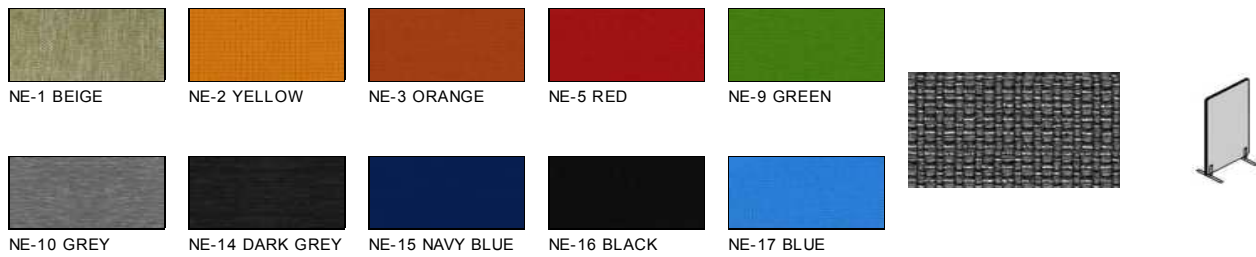

**FABRIC PANEL SONIC, VIVA - FABRIC RUNNER - SECOND GROUP**

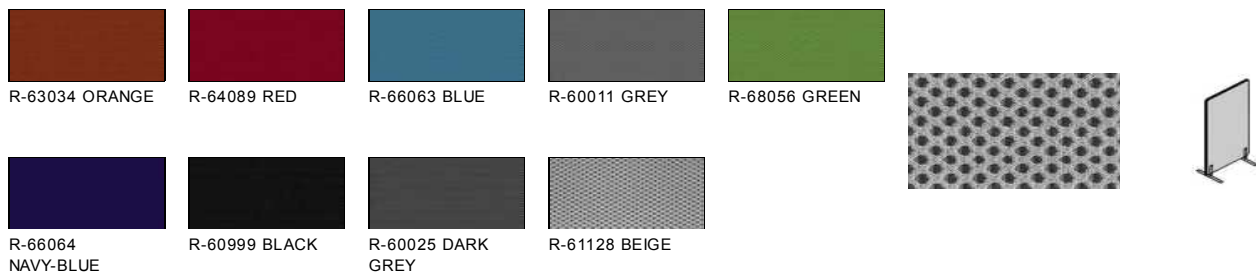

**FABRIC PANEL SONIC, VIVA - FABRIC MEDLEY - SECOND GROUP**

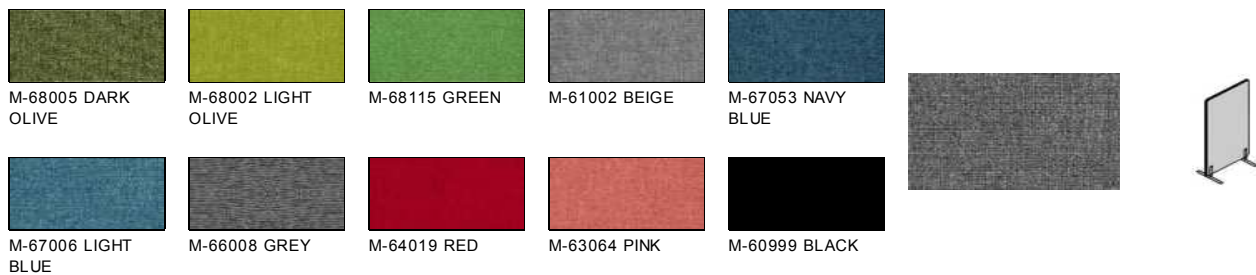

**FABRIC PANEL SONIC, VIVA - FABRIC ATLANTIC - SECOND GROUP**



**TECHNICAL SPECIFICATION**

**COLOURS**

**FABRIC PANEL SONIC, VIVA - FABRIC SYNERGY - THIRD PRICE GROUP**



**FABRIC PANEL SONIC, VIVA - FABRIC XTREME - THIRD PRICE GROUP**



**METAL ELEMENTS**

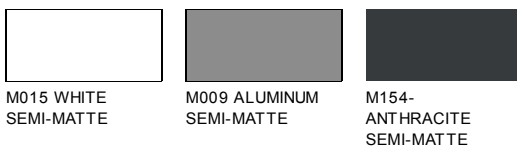
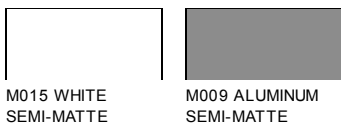

## TECHNICAL SPECIFICATION SONIC - FREE-STANDING SCREENS

- 1. Fire resistant - accoustic class A, pinable
- 2. Zip fastener
- 3. Foot - powder painted metal

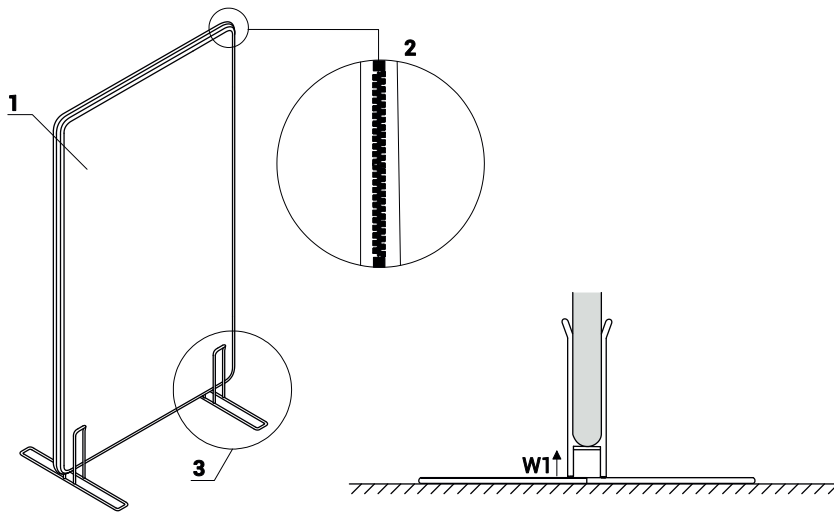

ATTENTION - Free standing panel in height W1 - 50mm from the bottom

## CONNECTING ELEMENT FOR FREE STANDING PANELS SONIC

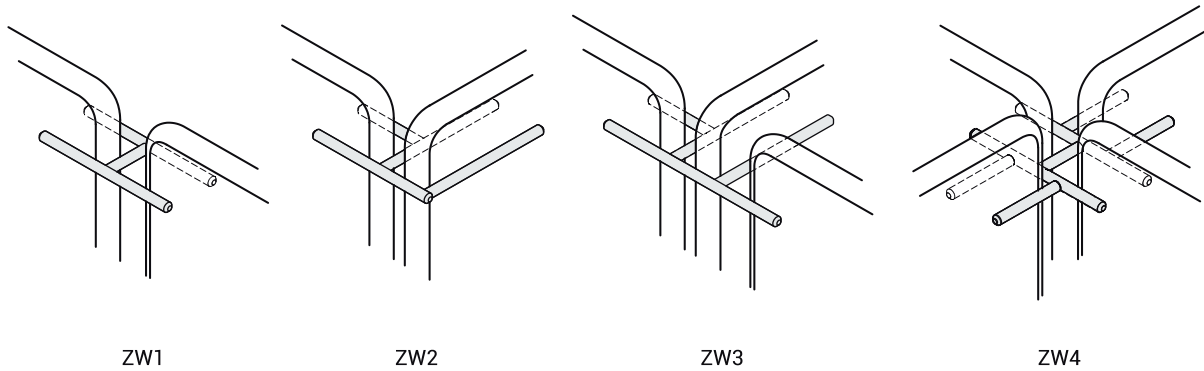

## TECHNICAL SPECIFICATION

### VIVA - FREE-STANDING SCREENS

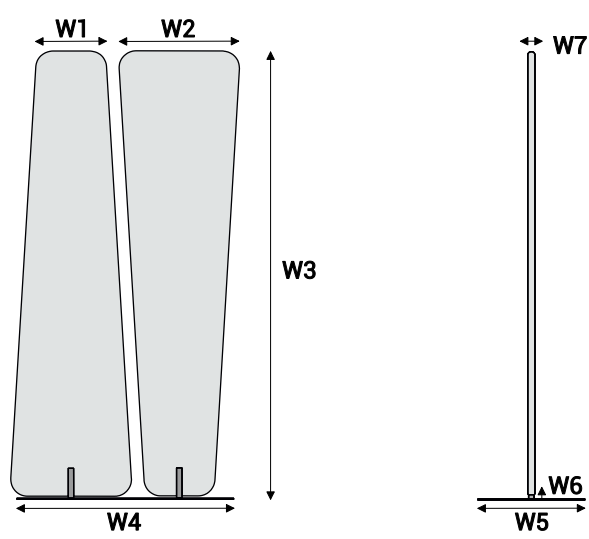
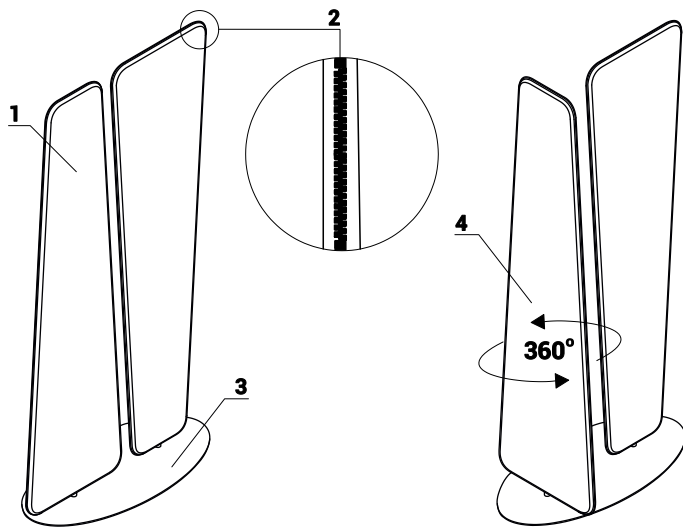

W1 - 258 | W2 - 443 | W3 - 1669 | W4 - 810 | W5 - 400 | W6 - 15 | W7 - 32

## TECHNICAL SPECIFICATION

### PARTITION WALLS

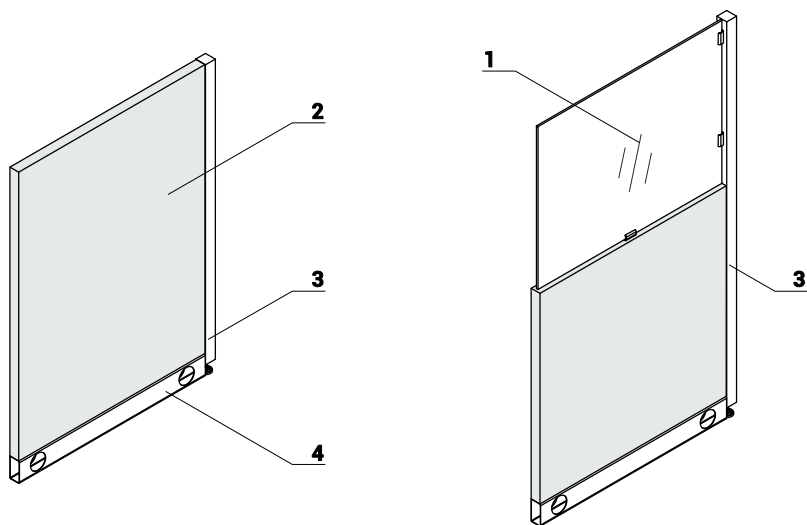

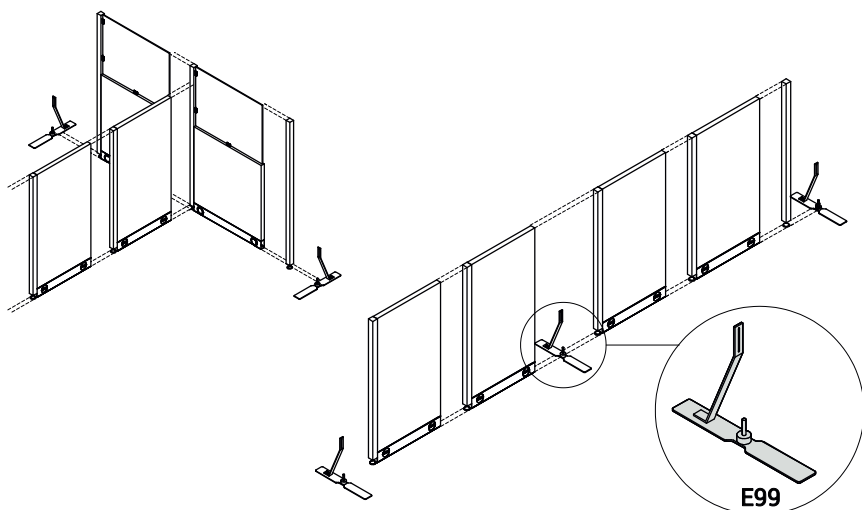

- 1. Tempered glass 6,4mm, transparent
- 2. **Partition wall** - 38mm, fabric
- 3. **Column** - 40x40mm or 40x80mm powder painted
- 4. Horizontal cable management



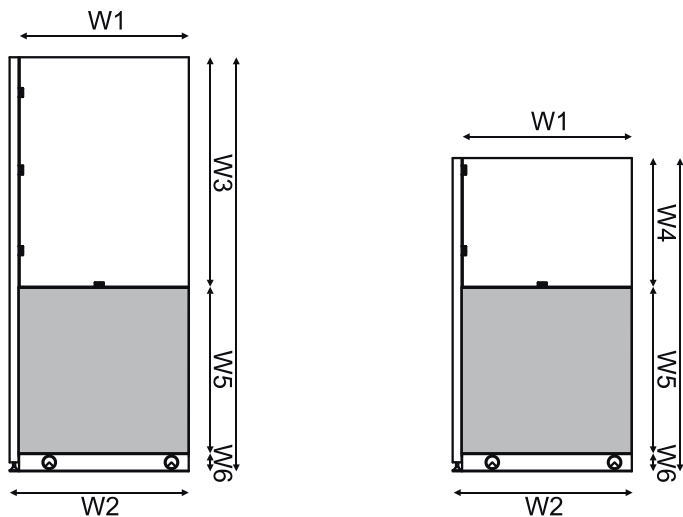







ATTENTION - Freestanding wall set needs E99 foot; for more info aks Client Service



W1 - 760mm | W2 - 800mm | W3 - 1025mm | W4 - 575mm | W5 - 740mm | W6 - 80mm

| PRODUCT ILLUSTRATION | DIMENSIONS [mm] |       |        | INDEX SYMBOL |  |  |  |  |  | COMMENTS |
|----------------------|-----------------|-------|--------|--------------|--|---|---|---|--|----------|
|                      | WIDTH           | DEPTH | HEIGHT |              |  | kg  | m3  | pcs   |  |          |

**SONIC - FREE-STANDING SCREENS**



|   |     |    |      |              |  |      |       |   |  |  |
|---|-----|----|------|--------------|--|------|-------|---|--|--|
|    | 650 | 40 | 1250 | <b>ZW612</b> |  | 18.0 | 0.051 | 2 |  |  |
|    | 650 | 40 | 1450 | <b>ZW614</b> |  | 19.0 | 0.058 | 2 |  |  |
|    | 650 | 40 | 1650 | <b>ZW616</b> |  | 20.0 | 0.065 | 2 |  |  |
|    | 650 | 40 | 1850 | <b>ZW618</b> |  | 21.0 | 0.071 | 2 |  |  |
|    | 800 | 40 | 1250 | <b>ZW812</b> |  | 16.0 | 0.061 | 2 |  |  |
|   | 800 | 40 | 1450 | <b>ZW814</b> |  | 17.0 | 0.069 | 2 |  |  |
|  | 800 | 40 | 1650 | <b>ZW816</b> |  | 18.0 | 0.077 | 2 |  |  |
|  | 800 | 40 | 1850 | <b>ZW818</b> |  | 19.0 | 0.085 | 2 |  |  |

DESCRIPTION



 - NET WEIGHT

 VOLUME

 NUMBER OF PACKAGES

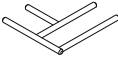
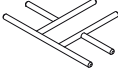

| PRODUCT ILLUSTRATION | DIMENSIONS [mm] |       |        | INDEX SYMBOL |  |  |  |  |  | COMMENTS |
|----------------------|-----------------|-------|--------|--------------|--|---|---|---|--|----------|
|                      | WIDTH           | DEPTH | HEIGHT |              |  | kg  | m3  | pcs   |  |          |

**CONNECTING ELEMENT FOR FREE STANDING PANELS SONIC**









|   |     |     |   |            |  |     |       |   |  |                  |
|---|-----|-----|---|------------|--|-----|-------|---|--|------------------|
|  | 52  | 128 | 8 | <b>ZW1</b> |  | 0.1 | 0.000 | 1 |  | For two panels   |
|  | 121 | 113 | 8 | <b>ZW2</b> |  | 0.2 | 0.000 | 1 |  | For two panels   |
|  | 121 | 173 | 8 | <b>ZW3</b> |  | 0.2 | 0.000 | 1 |  | For three panels |
|  | 172 | 128 | 8 | <b>ZW4</b> |  | 0.2 | 0.000 | 1 |  | For four panels  |

**VIVA - FREE-STANDING SCREENS**

|  |     |     |      |             |  |      |       |   |  |  |
|--|-----|-----|------|-------------|--|------|-------|---|--|--|
|  | 850 | 400 | 1670 | <b>VV02</b> |  | 19.7 | 0.084 | 3 |  |  |
|--|-----|-----|------|-------------|--|------|-------|---|--|--|

| PRODUCT ILLUSTRATION | DIMENSIONS [mm] |       |        | INDEX SYMBOL |  |  |  |  |  | COMMENTS |
|----------------------|-----------------|-------|--------|--------------|--|---|---|---|--|----------|
|                      | WIDTH           | DEPTH | HEIGHT |              |  | kg  | m3  | pcs   |  |          |

**FABRIC PARTITION WALLS CUBIC**

|   |      |    |      |              |  |      |       |   |  |                         |
|---|------|----|------|--------------|--|------|-------|---|--|-------------------------|
|    | 403  | 40 | 1100 | <b>UE512</b> |  | 12.0 | 0.023 | 1 |  | walls with post 40/40mm |
|    | 600  | 40 | 1100 | <b>UE52</b>  |  | 18.0 | 0.028 | 1 |  | walls with post 40/40mm |
|    | 800  | 40 | 1100 | <b>UE53</b>  |  | 23.0 | 0.037 | 1 |  | walls with post 40/40mm |
|    | 1000 | 40 | 1100 | <b>UE535</b> |  | 23.0 | 0.045 | 1 |  | walls with post 40/40mm |
|    | 1200 | 40 | 1100 | <b>UE54</b>  |  | 38.0 | 0.068 | 1 |  | walls with post 40/40mm |
|  | 443  | 40 | 1100 | <b>UE612</b> |  | 14.0 | 0.025 | 1 |  | walls with post 80/40mm |
|  | 640  | 40 | 1100 | <b>UE62</b>  |  | 20.0 | 0.036 | 1 |  | walls with post 80/40mm |
|  | 840  | 40 | 1100 | <b>UE63</b>  |  | 26.0 | 0.047 | 1 |  | walls with post 80/40mm |
|  | 1040 | 40 | 1100 | <b>UE635</b> |  | 23.0 | 0.045 | 1 |  | walls with post 80/40mm |



DESCRIPTION

 - NET WEIGHT









 VOLUME

 NUMBER OF PACKAGES



| PRODUCT ILLUSTRATION | DIMENSIONS [mm] |       |        | INDEX SYMBOL |  |  |  |  |  | COMMENTS |
|----------------------|-----------------|-------|--------|--------------|--|---|---|---|--|----------|
|                      | WIDTH           | DEPTH | HEIGHT |              |  | kg  | m3  | pcs   |  |          |

**FABRIC PARTITION WALLS CUBIC**



|   |      |    |      |              |  |      |       |   |  |                         |
|---|------|----|------|--------------|--|------|-------|---|--|-------------------------|
|    | 1240 | 40 | 1100 | <b>UE64</b>  |  | 37.8 | 0.069 | 1 |  | walls with post 80/40mm |
|    | 403  | 40 | 1400 | <b>UE712</b> |  | 16.0 | 0.029 | 1 |  | walls with post 40/40mm |
|    | 600  | 40 | 1400 | <b>UE72</b>  |  | 18.8 | 0.043 | 1 |  | walls with post 40/40mm |
|    | 800  | 40 | 1400 | <b>UE73</b>  |  | 23.0 | 0.045 | 1 |  | walls with post 40/40mm |
|    | 1000 | 40 | 1400 | <b>UE735</b> |  | 23.0 | 0.057 | 1 |  | walls with post 40/40mm |
|  | 1200 | 40 | 1400 | <b>UE74</b>  |  | 33.0 | 0.067 | 1 |  | walls with post 40/40mm |
|  | 443  | 40 | 1400 | <b>UE812</b> |  | 17.0 | 0.032 | 1 |  | walls with post 80/40mm |
|  | 640  | 40 | 1400 | <b>UE82</b>  |  | 25.2 | 0.046 | 1 |  | walls with post 80/40mm |
|  | 840  | 40 | 1400 | <b>UE83</b>  |  | 32.8 | 0.060 | 1 |  | walls with post 80/40mm |

DESCRIPTION









 - NET WEIGHT

 VOLUME

 NUMBER OF PACKAGES

| PRODUCT ILLUSTRATION | DIMENSIONS [mm] |       |        | INDEX SYMBOL |  |  |  |  |  | COMMENTS |
|----------------------|-----------------|-------|--------|--------------|--|---|---|---|--|----------|
|                      | WIDTH           | DEPTH | HEIGHT |              |  | kg  | m3  | pcs   |  |          |

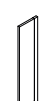
**FABRIC PARTITION WALLS CUBIC**



|   |      |    |      |              |  |      |       |   |  |                         |
|---|------|----|------|--------------|--|------|-------|---|--|-------------------------|
|    | 1040 | 40 | 1400 | <b>UE835</b> |  | 32.8 | 0.074 | 1 |  | walls with post 80/40mm |
|    | 1240 | 40 | 1400 | <b>UE84</b>  |  | 47.9 | 0.088 | 1 |  | walls with post 80/40mm |
|    | 403  | 40 | 1850 | <b>UE352</b> |  | 20.0 | 0.039 | 1 |  | walls with post 40/40mm |
|    | 600  | 40 | 1850 | <b>UE36</b>  |  | 28.5 | 0.045 | 1 |  | walls with post 40/40mm |
|    | 800  | 40 | 1850 | <b>UE37</b>  |  | 37.7 | 0.060 | 1 |  | walls with post 40/40mm |
|  | 1000 | 40 | 1850 | <b>UE375</b> |  | 37.7 | 0.075 | 1 |  | walls with post 40/40mm |
|  | 1200 | 40 | 1850 | <b>UE38</b>  |  | 50.0 | 0.090 | 1 |  | walls with post 40/40mm |
|  | 443  | 40 | 1850 | <b>UE452</b> |  | 21.0 | 0.042 | 1 |  | walls with post 80/40mm |
|  | 640  | 40 | 1850 | <b>UE46</b>  |  | 30.4 | 0.048 | 1 |  | walls with post 80/40mm |

DESCRIPTION



 - NET WEIGHT

 VOLUME

 NUMBER OF PACKAGES



| PRODUCT ILLUSTRATION | DIMENSIONS [mm] |       |        | INDEX SYMBOL |  |  |  |  |  | COMMENTS |
|----------------------|-----------------|-------|--------|--------------|--|---|---|---|--|----------|
|                      | WIDTH           | DEPTH | HEIGHT |              |  | kg  | m3  | pcs   |  |          |

**FABRIC PARTITION WALLS CUBIC**









|   |      |    |      |              |  |      |       |   |  |                         |
|---|------|----|------|--------------|--|------|-------|---|--|-------------------------|
|  | 840  | 40 | 1850 | <b>UE47</b>  |  | 39.6 | 0.063 | 1 |  | walls with post 80/40mm |
|  | 1040 | 40 | 1850 | <b>UE475</b> |  | 39.6 | 0.078 | 1 |  | walls with post 80/40mm |
|  | 1240 | 40 | 1850 | <b>UE48</b>  |  | 57.9 | 0.093 | 1 |  | walls with post 80/40mm |

**FOOT**

|   |    |     |     |            |  |     |       |   |  |                          |
|---|----|-----|-----|------------|--|-----|-------|---|--|--------------------------|
|  | 70 | 500 | 360 | <b>E99</b> |  | 1.0 | 0.002 | 1 |  | foot for partition walls |
|---|----|-----|-----|------------|--|-----|-------|---|--|--------------------------|

| PRODUCT ILLUSTRATION | DIMENSIONS [mm] |       |        | INDEX SYMBOL |  |  |  |  |  | COMMENTS |
|----------------------|-----------------|-------|--------|--------------|--|---|---|---|--|----------|
|                      | WIDTH           | DEPTH | HEIGHT |              |  | kg  | m3  | pcs   |  |          |

**PARTITION WALLS WITH GLASS CUBIC**

|   |      |    |      |               |  |      |       |   |  |   |
|---|------|----|------|---------------|--|------|-------|---|--|---|
|    | 600  | 40 | 1400 | <b>UESO36</b> |  | 21.4 | 0.058 | 2 |  | walls with post 40/40mm, transparent safety glass |
|    | 800  | 40 | 1400 | <b>UESO37</b> |  | 27.4 | 0.078 | 2 |  | walls with post 40/40mm, transparent safety glass |
|    | 1200 | 40 | 1400 | <b>UESO38</b> |  | 38.4 | 0.117 | 2 |  | walls with post 40/40mm, transparent safety glass |
|    | 640  | 40 | 1400 | <b>UESO46</b> |  | 23.0 | 0.062 | 2 |  | walls with post 80/40mm, transparent safety glass |
|    | 840  | 40 | 1400 | <b>UESO47</b> |  | 29.0 | 0.082 | 2 |  | walls with post 80/40mm, transparent safety glass |
|  | 1240 | 40 | 1400 | <b>UESO48</b> |  | 40.0 | 0.121 | 2 |  | walls with post 80/40mm, transparent safety glass |
|  | 600  | 40 | 1850 | <b>UESO72</b> |  | 38.0 | 0.085 | 2 |  | walls with post 40/40mm, transparent safety glass |
|  | 800  | 40 | 1850 | <b>UESO73</b> |  | 44.0 | 0.113 | 2 |  | walls with post 40/40mm, transparent safety glass |
|  | 1200 | 40 | 1850 | <b>UESO74</b> |  | 56.0 | 0.169 | 2 |  | walls with post 40/40mm, transparent safety glass |

DESCRIPTION

 - NET WEIGHT

 VOLUME

 NUMBER OF PACKAGES

| PRODUCT ILLUSTRATION | DIMENSIONS [mm] |       |        | INDEX SYMBOL |  |    |    |     |  | COMMENTS |
|----------------------|-----------------|-------|--------|--------------|--|----|----|-----|--|----------|
|                      | WIDTH           | DEPTH | HEIGHT |              |  | kg | m3 | pcs |  |          |

### PARTITION WALLS WITH GLASS CUBIC

|  |      |    |      |               |  |      |       |   |  |   |
|--|------|----|------|---------------|--|------|-------|---|--|---|
|  | 640  | 40 | 1850 | <b>UESO82</b> |  | 40.0 | 0.089 | 2 |  | walls with post 80/40mm, transparent safety glass |
|  | 840  | 40 | 1850 | <b>UESO83</b> |  | 46.0 | 0.117 | 2 |  | walls with post 80/40mm, transparent safety glass |
|  | 1240 | 40 | 1850 | <b>UESO84</b> |  | 58.0 | 0.173 | 2 |  | walls with post 80/40mm, transparent safety glass |

### METAL POSTS FOR FABRIC PARTITIONS

|  |    |    |      |              |  |     |       |   |  |  |
|--|----|----|------|--------------|--|-----|-------|---|--|--|
|  | 40 | 40 | 1100 | <b>EE43</b>  |  | 3.0 | 0.003 | 1 |  |  |
|  | 40 | 80 | 1100 | <b>EE44</b>  |  | 3.5 | 0.005 | 1 |  |  |
|  | 40 | 40 | 1400 | <b>EE45</b>  |  | 3.8 | 0.003 | 1 |  |  |
|  | 40 | 80 | 1400 | <b>EE46</b>  |  | 5.5 | 0.006 | 1 |  |  |
|  | 40 | 40 | 1850 | <b>EE411</b> |  | 4.5 | 0.005 | 1 |  |  |
|  | 40 | 80 | 1850 | <b>EE421</b> |  | 6.6 | 0.008 | 1 |  |  |

DESCRIPTION

- NET WEIGHT

VOLUME

NUMBER OF PACKAGES

| PRODUCT ILLUSTRATION | DIMENSIONS [mm] |       |        | INDEX SYMBOL |  |    |    |     |  | COMMENTS |
|----------------------|-----------------|-------|--------|--------------|--|----|----|-----|--|----------|
|                      | WIDTH           | DEPTH | HEIGHT |              |  | kg | m3 | pcs |  |          |

## COPPLEMENTARY ELEMENTS

|  |      |     |     |            |  |      |       |   |  |   |
|--|------|-----|-----|------------|--|------|-------|---|--|---|
|  | 800  | 390 | 430 | <b>J21</b> |  | 16.0 | 0.155 | 1 |  | overhead storage for partition walls; 26 - aluminum satinato; 67 - white pastel or 154 - anthracite |
|  | 1200 | 390 | 430 | <b>J22</b> |  | 21.7 | 0.230 | 1 |  | overhead storage for partition walls; 26 - aluminum satinato; 67 - white pastel or 154 - anthracite |
|  | 800  | 390 | 430 | <b>J27</b> |  | 17.3 | 0.155 | 1 |  | overhead storage for partition walls; 26 - aluminum satinato; 67 - white pastel or 154 - anthracite |

DESCRIPTION

- NET WEIGHT

VOLUME

NUMBER OF PACKAGES