

## TECHNICAL SPECIFICATION

### COLOURS

#### TOP, BOTTOM



14 BEECH

 26 ALUMINUM  
SATINATO

31 CANADIAN OAK



34 CHESTNUT



39 POLAR BIRCH



64 COCOA

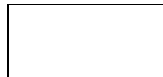

67 WHITE PASTEL

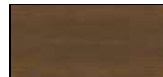

106 LOWLAND NUT



154 ANTHRACITE



#### BODY

 26 ALUMINUM  
SATINATO

67 WHITE PASTEL



154 ANTHRACITE



#### FRONT



14 BEECH

 26 ALUMINUM  
SATINATO

31 CANADIAN OAK



34 CHESTNUT



39 POLAR BIRCH



64 COCOA



67 WHITE PASTEL



106 LOWLAND NUT



154 ANTHRACITE



#### MOBILE PEDESTAL KKT11, KKT110

 26 ALUMINUM  
SATINATO

67 WHITE PASTEL



154 ANTHRACITE



#### CUSHION SKP13 - FABRIC NEMO



NE-1 BEIGE



NE-2 YELLOW



NE-3 ORANGE



NE-5 RED



NE-9 GREEN



NE-10 GREY



NE-14 DARK GREY



NE-15 NAVY BLUE



NE-16 BLACK



NE-17 BLUE

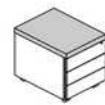

#### CUSHION SKP13 - FABRIC RUNNER - SECOND GROUP



R-63034 ORANGE



R-64089 RED



R-66063 BLUE



R-60011 GREY

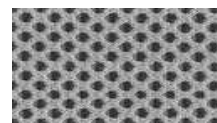

R-68056 GREEN

 R-66064  
NAVY-BLUE

R-60999 BLACK

 R-60025 DARK  
GREY



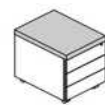









R-61128 BEIGE



**TECHNICAL SPECIFICATION**

**COLOURS**

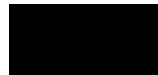







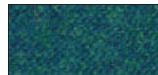

**CUSHION SKP13 - FABRIC MEDLEY - SECOND GROUP**

						
M-68005 DARK OLIVE	M-68002 LIGHT OLIVE	M-68115 GREEN	M-61002 BEIGE	M-67053 NAVY BLUE		
						
M-67006 LIGHT BLUE	M-66008 GREY	M-64019 RED	M-63064 PINK	M-60999 BLACK		

**CUSHION SKP13 - FABRIC ATLANTIC - SECOND GROUP**

						
A-67043 DARK TURQUOISE	A-67030 SEA-GREEN	A-60141 LIGHT GREY	A-60011 GREY	A-66064 NAVY BLUE		
						
A-65037 VIOLET	A-62048 OLIVE	A-64089 RED	A-61078 BEIGE	A-60025 GRAPHITE		

**CUSHION SKP13 - FABRIC SYNERGY - THIRD PRICE GROUP**

						
LDS08 GREY MELANGE	LDS20 LIGHT GREY	LDS27 BLACK	LDS29 DARK GREY	LDS50 DARK GREEN		
						
LDS53 GREEN	LDS57 TURQUOISE	LDS60 BOTTLE GREEN	LDS61 PLUM	LDS69 NAVY BLUE		
						
LDS84 ORANGE	LDS86 RED	LDS88 AUBERGINE	LDS85 CORAL			

**CUSHION SKP13 - FABRIC XTREME - THIRD PRICE GROUP**

						
XR160 SEA-GREEN	XR430 DARK TURQUOISE	XR026 NAVY BLUE	XR084 VIOLET	XR009 BLACK		
						
XR420 OLIVE	XR081 DARK GREY	XR094 GREY	XR108 BEIGE	XR079 RED		
						
YS158 BROWN	YS083 BLUE-GREY	YS071 LIGHT BROWN	YS166 SAND BROWN			

TECHNICAL SPECIFICATION

MOBILE PEDESTAL WITHOUT HANDLES

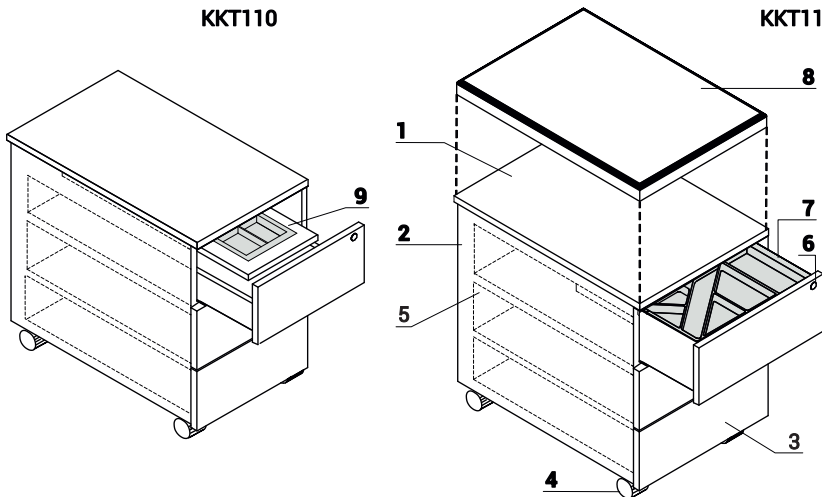

- 1. **Top** - MFC 18mm, PVC edge
- 2. **Body** - MFC 18mm, PVC edge
- 3. **Front** - MFC 18mm, PVC edge
- 4. **Castors** - Ø50mm, two with brakes
- 5. **MFC drawer** - roll runners, max load 25kg, 80% extraction
- 6. **Central lock** - foldable key
- 7. **Pencil tray** - black plastic
- 8. **Cushion SKP13** - for pedestal, order separately, max load 120kg
- 9. **Sliding pencil tray** - MFC 18mm

ATTENTION - no sitting on pedestal KKT11 without castors support; to be ordered with cushion SKP13

PEDESTALS

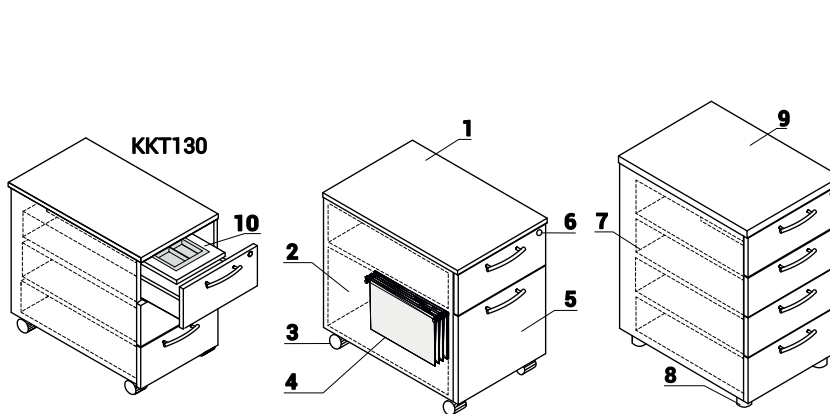

- 1. **Top** - MFC 18mm, PVC edge
- 2. **Body** - MFC 18mm, PVC edge
- 3. **Castors** - Ø50mm, two with brakes
- 4. **Suspension files drawer** - max load 30kg, 100% extraction
- 5. **Front** - MFC 18mm, PVC edge
- 6. **Central lock** - foldable key
- 7. **MFC drawer** - roll runners, max load 25kg, 80% extraction
- 8. **Leveling** - 5mm range
- 9. **Top** - MFC 28mm, PVC edge
- 10. **Sliding pencil tray** - MFC 18mm

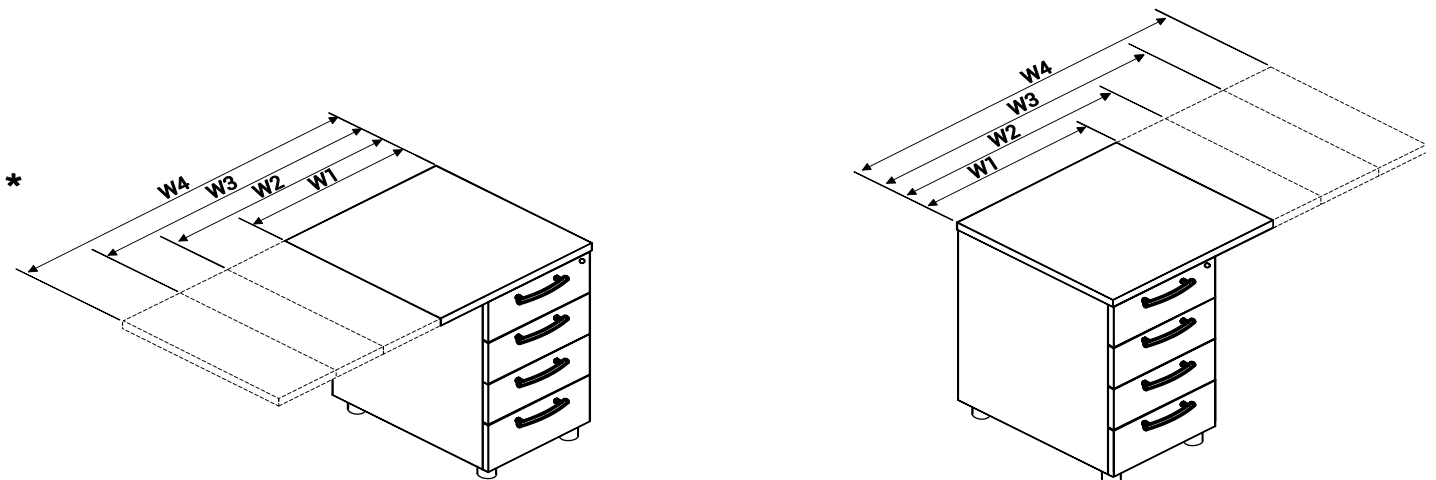

\* Pedestal with top overhang - W1 - 600mm | W2 - 800mm | W3 - 1000mm | W4 - 1200mm

PRODUCT ILLUSTRATION	DIMENSIONS [mm]			INDEX SYMBOL						COMMENTS
	WIDTH	DEPTH	HEIGHT			kg	m3	pcs		

## MOBILE PEDESTAL WITHOUT HANDLES

	348	600	586	<b>KKT110</b>		22.0	0.122	1		no handles, colours: white, aluminum, anthracite
	416	600	586	<b>KKT11</b>		26.0	0.153	1		no handles, colours: white, aluminum, anthracite

## PEDESTAL CUSHION

	400	600	52	<b>SKP13</b>		3.0	0.017	1		
--	-----	-----	----	--------------	--	-----	-------	---	--	--

## PEDESTALS

	334	600	586	<b>KKT130</b>		22.0	0.120	1		drawers depth - 500mm
	402	600	586	<b>KKT13</b>		26.0	0.142	1		drawers depth - 500mm
	402	600	586	<b>KKT12</b>		32.0	0.141	1		mobile with suspension files drawer, drawers depth - 500mm
	402	600	740	<b>KKT64</b>		34.0	0.195	1		drawers depth - 500mm
	402	800	740	<b>KKT74</b>		37.0	0.258	1		drawers depth - 500mm

## ADDITIONAL CHARGE

FEATURE	PRODUCT												COMMENTS
			SKP13							kg	m3	pcs	
II PRICE GROUP										0.0	0.0000	0	
III PRICE GROUP										1.0	0.0010	1	

DESCRIPTION

- NET WEIGHT

VOLUME

NUMBER OF PACKAGES

PRODUCT ILLUSTRATION	DIMENSIONS [mm]			INDEX SYMBOL						COMMENTS
	WIDTH	DEPTH	HEIGHT			kg	m3	pcs		

## PEDESTLS WITH TOP OVERHANG 600 mm WIDE

	600	600	740	<b>KT664</b>		35.0	0.209	4		Flat bar for fixing to the top included
	600	800	740	<b>KT674</b>		39.0	0.275	4		Flat bar for fixing to the top included

## PEDESTLS WITH TOP OVERHANG 800 mm WIDE

	800	600	740	<b>KT864</b>		37.0	0.213	4		Flat bar for fixing to the top included
	800	800	740	<b>KT874</b>		41.9	0.281	4		Flat bar for fixing to the top included

## PEDESTLS WITH TOP OVERHANG 1000 mm WIDE

	1000	600	740	<b>KT1064</b>		38.9	0.218	4		Flat bar for fixing to the top included
	1000	800	740	<b>KT1074</b>		44.9	0.287	4		Flat bar for fixing to the top included

## PEDESTLS WITH TOP OVERHANG 1200 mm WIDE

	1200	600	740	<b>KT1264</b>		41.4	0.222	4		Flat bar for fixing to the top included
	1200	800	740	<b>KT1274</b>		47.9	0.293	4		Flat bar for fixing to the top included

DESCRIPTION

- NET WEIGHT

VOLUME

NUMBER OF PACKAGES



## TECHNICAL SPECIFICATION

### COLOURS

#### TOP, BOTTOM



14 BEECH



26 ALUMINUM  
SATINATO



31 CANADIAN OAK



34 CHESTNUT



39 POLAR BIRCH



64 COCOA



67 WHITE PASTEL



106 LOWLAND NUT



154 ANTHRACITE

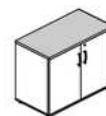

#### BODY



26 ALUMINUM  
SATINATO



67 WHITE PASTEL



154 ANTHRACITE

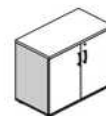

#### FRONT



14 BEECH



26 ALUMINUM  
SATINATO



31 CANADIAN OAK



34 CHESTNUT



39 POLAR BIRCH



64 COCOA

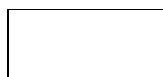

67 WHITE PASTEL

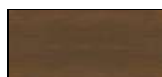

106 LOWLAND NUT



154 ANTHRACITE

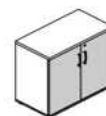

#### TOP, BOTTOM, BODY



154 ANTHRACITE



26 ALUMINUM  
SATINATO



67 WHITE PASTEL



#### FRONT - TAMBOUR



08 BLACK



09 ALUMINUM



30 WHITE



## TECHNICAL SPECIFICATION

### STORAGES

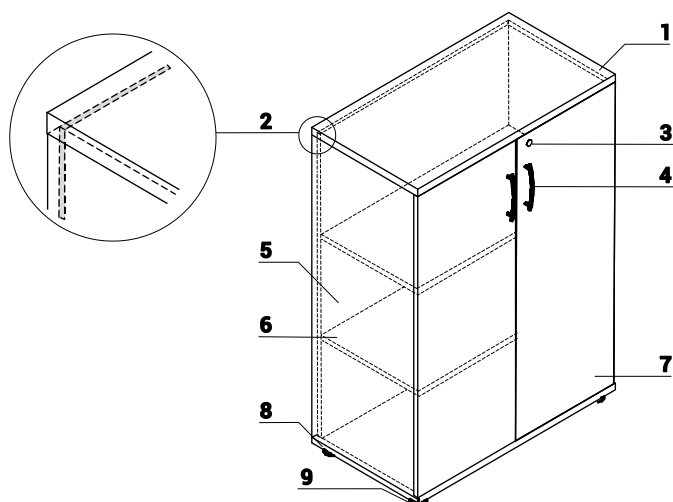

1. **Top** - MFC 28mm, PVC edge
2. **Back MFC** - 3mm
3. **Patent lock**
4. **Aluminum handle**
5. **Side panels** - MFC 18mm, PVC edge
6. **Shelf** - MFC 18mm, PVC edge
7. **Front** - MFC 18mm, PVC edge, plain hinge 110°
8. **Base** - MFC 18mm, PVC edge
9. **Leveling feet 27mm** - range 12mm

ATTENTION - Raw 3mm HDF is visible on the back

### ADDITIONAL ELEMENTS FOR STORAGE

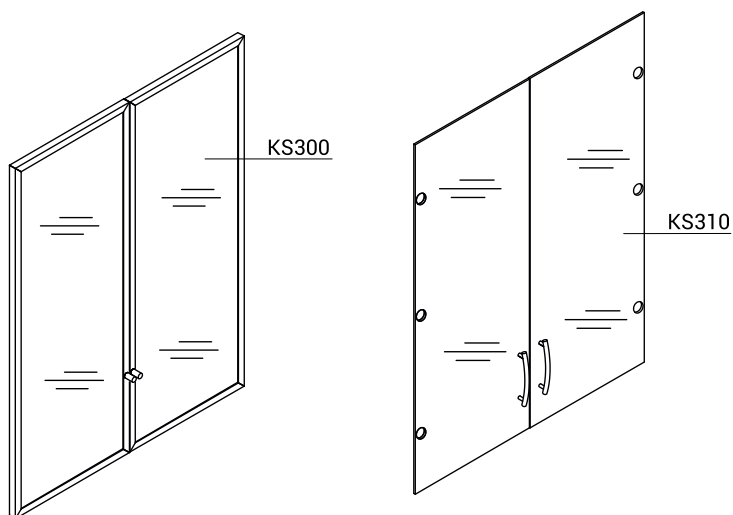



#### KS300

- glass door 30H
- frosted tempered glass 4mm, with aluminum frame







#### KS310

- glass door 30H
- transparent tempered glass 4mm





PRODUCT ILLUSTRATION	DIMENSIONS [mm]			INDEX SYMBOL						COMMENTS
	WIDTH	DEPTH	HEIGHT			kg	m3	pcs		

**50H STORAGEES**

	801	385	1833	<b>K5504</b>		40.0	0.100	2		visible back panel, raw HDF 3mm
	801	385	1833	<b>K5404</b>		47.0	0.120	3		visible back panel, raw HDF 3mm
	801	385	1833	<b>K5304</b>		51.3	0.126	3		visible back panel, raw HDF 3mm
	801	385	1833	<b>K5104</b>		58.7	0.142	3		visible back panel, raw HDF 3mm
	801	385	1833	<b>K5204</b>		50.0	0.116	3		wardrobe with slide out hanger, raw 3mm HDF is visible on the back, no zip
	801	385	1833	<b>K52P4</b>		0.0	0.001	0		wardrobe/storage cabinet with slide-out hanger

**30H STORAGEES**



	801	385	1129	<b>K3504</b>		25.0	0.059	2		visible back panel, raw HDF 3mm
	801	385	1129	<b>K3404</b>		32.0	0.078	3		visible back panel, raw HDF 3mm
	801	385	1129	<b>K3104</b>		36.3	0.085	3		visible back panel, raw HDF 3mm

DESCRIPTION





 - NET WEIGHT

 VOLUME



 NUMBER OF PACKAGES

PRODUCT ILLUSTRATION	DIMENSIONS [mm]			INDEX SYMBOL						COMMENTS
	WIDTH	DEPTH	HEIGHT			kg	m3	pcs		

**2OH STORAGEES**

	801	385	777	<b>K2504</b>		19.0	0.049	2		visible back panel, raw HDF 3mm
	801	385	777	<b>K2104</b>		26.0	0.069	3		visible back panel, raw HDF 3mm
	801	385	740	<b>K25B4</b>		18.5	0.048	2		visible back panel, raw HDF 3mm
	801	385	740	<b>K21B4</b>		25.0	0.067	3		visible back panel, raw HDF 3mm

**2 OH STACK-ON STORAGEES**

	801	385	750	<b>K1504</b>		19.0	0.049	2		back - HDF 3mm
	801	385	750	<b>K1104</b>		26.0	0.069	3		back - HDF 3mm

**TAMBOUR STORAGE**

	1200	385	1129	<b>K3Z06</b>		64.0	0.600	1		Top and body available in colors: 26 - aluminum satinato; 67 - white pastel, 154 - anthracite Tambour front available in colors: 09 - aluminum; 08 - black or 30 - white
---	------	-----	------	--------------	--	------	-------	---	--	--

**PRINTER STORAGE**

	710	600	600	<b>S85</b>		32.0	0.066	1		under printer storage, all in 26 - aluminum satinato or 67 - white pastel or 154 - anthracite
---	-----	-----	-----	------------	--	------	-------	---	--	--

DESCRIPTION

 - NET WEIGHT

 VOLUME

 NUMBER OF PACKAGES

PRODUCT ILLUSTRATION	DIMENSIONS [mm]			INDEX SYMBOL						COMMENTS
	WIDTH	DEPTH	HEIGHT			kg	m3	pcs		

## ADDITIONAL ELEMENTS FOR STORAGE

	800	5	1050	<b>KS310</b>		12.0	0.034	1		glass doors (2pcs) 3OH, transparent tempered glass
	800	20	1050	<b>KS300</b>		10.3	0.037	1		glass doors (2pcs) 3OH with aluminum frame, frosted tempered glass

DESCRIPTION

- NET WEIGHT

VOLUME

NUMBER OF PACKAGES



TECHNICAL SPECIFICATION

COLOURS

MOBILE PEDESTAL SLD

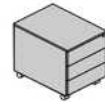
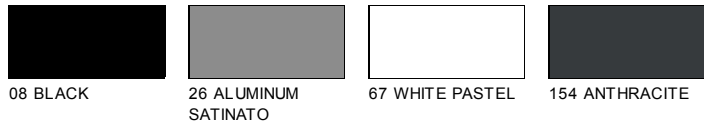

CUSHION SKP13 - FABRIC NEMO

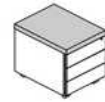
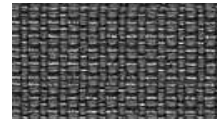

CUSHION SKP13 - FABRIC RUNNER - SECOND GROUP

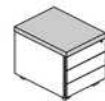
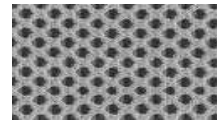

CUSHION SKP13 - FABRIC MEDLEY - SECOND GROUP

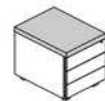

CUSHION SKP13 - FABRIC ATLANTIC - SECOND GROUP

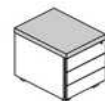
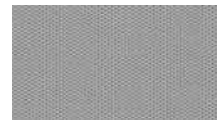

## TECHNICAL SPECIFICATION

### COLOURS

#### CUSHION SKP13 - FABRIC SYNERGY - THIRD PRICE GROUP



#### CUSHION SKP13 - FABRIC XTREME - THIRD PRICE GROUP



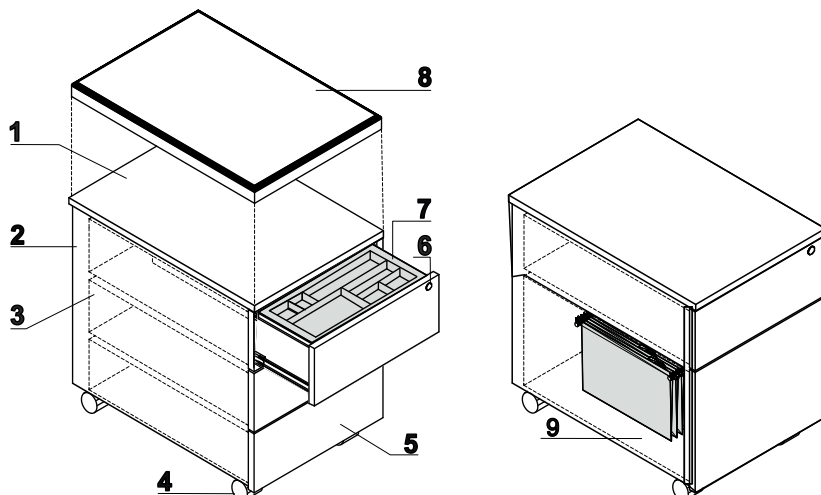

### MOBILE PEDESTAL WITHOUT HANDLES







1. **Top** - MFC 18mm, PVC edge
2. **Body** - MFC 18mm, PVC edge
3. **Metal drawer** - roll runners, max load 25kg, 80% extraction; Anti - tilt mechanism; OPTIONAL: ball runners, soft closing
4. **Castors** - Ø50mm, two with brakes
5. **Front** - MFC 18mm, PVC edge
6. **Central lock** - foldable key
7. **Pencil tray** - black plastic
8. **Cushion SKP13** - for pedstal, order separately, max load 120kg
9. **Suspension files drawer** - ball runners, max load 30kg, 100% extraction, A4 folders must be inserted parallelly to the front

ATTENTION - no sitting on pedestals without castors support; to be ordered with cushion SKP13

PRODUCT ILLUSTRATION	DIMENSIONS [mm]			INDEX SYMBOL						COMMENTS
	WIDTH	DEPTH	HEIGHT			kg	m3	pcs		



**MOBILE PEDESTAL WITHOUT HANDLES**

	416	600	586	<b>SLD12</b>		30.0	0.158	1		mobile with suspension files drawer, drawers depth - 500mm
	416	600	586	<b>SLD13</b>		23.0	0.158	1		drawers depth - 500mm
	416	800	586	<b>SLD120</b>		26.0	0.207	1		mobile with suspension files drawer, drawers depth - 500mm
	416	800	586	<b>SLD130</b>		27.0	0.207	1		drawers depth - 500mm

**PEDESTAL CUSHION**

	400	600	52	<b>SKP13</b>		3.0	0.017	1		
--	-----	-----	----	--------------	--	-----	-------	---	--	--

**ADDITIONAL CHARGE**

FEATURE	PRODUCT									COMMENTS
	SLD12	SLD13	SLD120	SLD130	SKP13		kg	m3	pcs	
II PRICE GROUP							0.9	0.0070	1	
III PRICE GROUP							0.0	0.0000	0	
SELF CLOSING SYSTEM							1.0	0.0010	1	
BALL RUNNERS							1.0	0.0010	1	

DESCRIPTION

 - NET WEIGHT

 VOLUME

 NUMBER OF PACKAGES





TECHNICAL SPECIFICATION

COLOURS

TOP, BOTTOM



14 BEECH



26 ALUMINUM SATINATO



31 CANADIAN OAK



34 CHESTNUT



39 POLAR BIRCH



64 COCOA

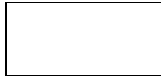

67 WHITE PASTEL



106 LOWLAND NUT



154 ANTHRACITE



BODY - FIRST GROUP



26 ALUMINUM SATINATO



67 WHITE PASTEL



154 ANTHRACITE



BODY - SECOND GROUP



14 BEECH



31 CANADIAN OAK



34 CHESTNUT



39 POLAR BIRCH



64 COCOA



106 LOWLAND NUT



FRONT



14 BEECH



26 ALUMINUM SATINATO



31 CANADIAN OAK



34 CHESTNUT



39 POLAR BIRCH



64 COCOA

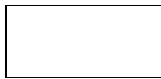

67 WHITE PASTEL



106 LOWLAND NUT



154 ANTHRACITE



TECHNICAL SPECIFICATION

KDT PEDESTALS

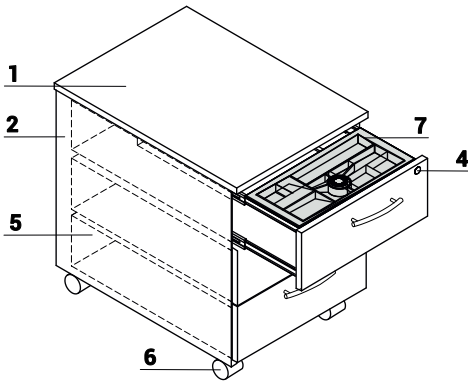

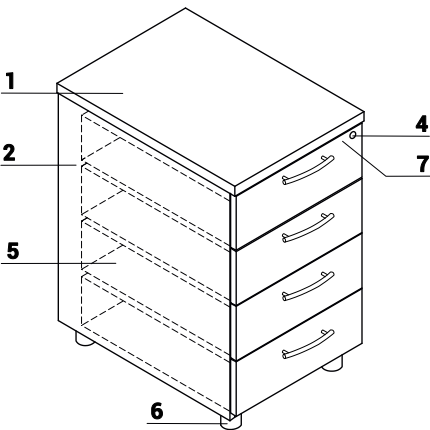
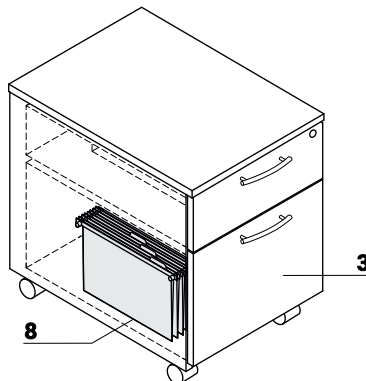

1. **Top** - MFC 18mm, PVC edge
2. **Body** - MFC 18mm, PVC edge
3. **Front** - MFC 18mm, PVC edge
4. **Central lock** - foldable key
5. **Metal drawer** - roll runners, max load 25kg, 80% extraction; Anti - tilt mechanism; OPTIONAL: ball runners, soft closing
6. **Castors** - Ø50mm, two with brakes
7. **Pencil tray** - black plastic
8. **Suspension files drawer** - ball runners, max load 30kg, 100% extraction, A4 folders must be inserted parallelly to the front



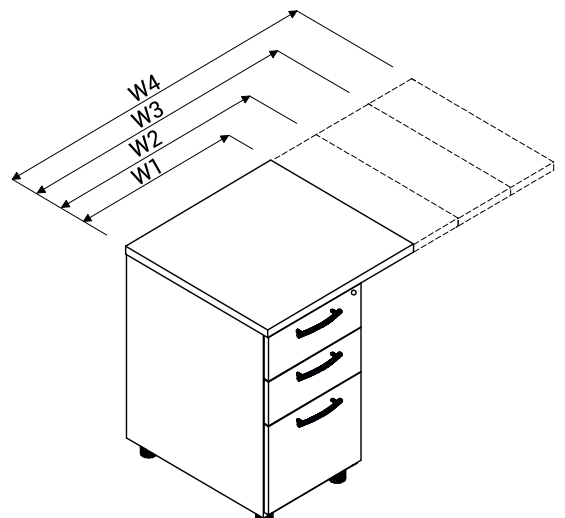
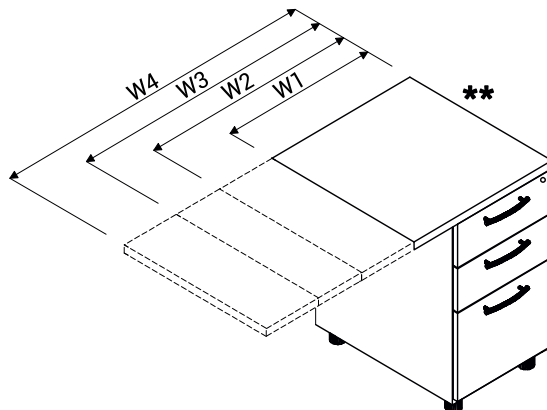
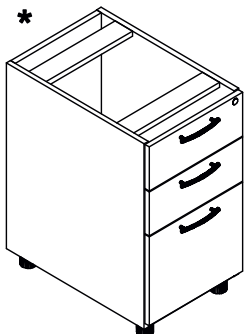
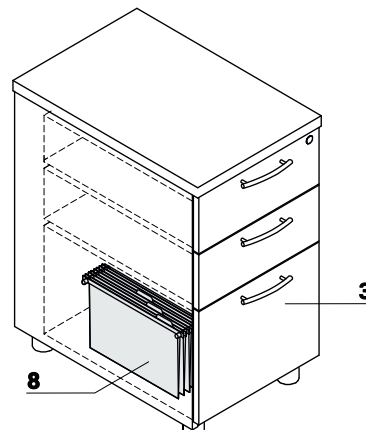







1. **Top** - MFC 28mm, PVC edge
2. **Body** - MFC 18mm, PVC edge
3. **Front** - MFC 18mm, PVC edge
4. **Central lock** - foldable key
5. **Metal drawer** - roll runners, max load 25kg, 80% extraction; Anti - tilt mechanism; OPTIONAL: ball runners, soft closing
6. **Leveling** - 5mm range
7. **Pencil tray** - black plastic
8. **Suspension files drawer** - ball runners, max load 30kg, 100% extraction, A4 folders must be inserted parallelly to the front





\* Pedestals without tops - W1 - 600mm | W2 - 800mm | W3 - 1000mm | W4 - 1200mm

PRODUCT ILLUSTRATION	DIMENSIONS [mm]			INDEX SYMBOL						COMMENTS
	WIDTH	DEPTH	HEIGHT			kg	m3	pcs		

**KDT PEDESTALS**

	402	600	586	<b>KDT12</b>		30.0	0.151	1		mobile with suspension files drawer, drawers depth - 500mm
	402	600	586	<b>KDT13</b>		23.0	0.151	1		mobile; drawers depth - 500mm
	402	800	586	<b>KDT120</b>		33.0	0.198	1		mobile with suspension files drawer; drawers depth: standard - 500mm, file - 700mm
	402	800	586	<b>KDT130</b>		26.0	0.198	1		mobile; drawers depth - 500mm
	402	600	740	<b>KDT63</b>		27.0	0.211	1		file drawer; drawers depth - 500mm
	402	600	740	<b>KDT64</b>		28.0	0.193	1		drawers depth - 500mm
	402	800	740	<b>KDT73</b>		32.0	0.255	1		file drawer; drawers depth: standard - 500mm, file - 700mm
	402	800	740	<b>KDT74</b>		33.0	0.255	1		drawers depth - 500mm

**ADDITIONAL CHARGE**



FEATURE	PRODUCT											COMMENTS
	KDT12	KDT13	KDT120	KDT130	KDT63	KDT64	KDT73	KDT74	kg	m3	pcs	
II PRICE GROUP									0.0	0.0000	0	
SELF CLOSING SYSTEM									1.0	0.0010	1	
BALL RUNNERS									1.0	0.0010	1	

DESCRIPTION





 - NET WEIGHT

 VOLUME





 NUMBER OF PACKAGES

PRODUCT ILLUSTRATION	DIMENSIONS [mm]			INDEX SYMBOL						COMMENTS
	WIDTH	DEPTH	HEIGHT			kg	m3	pcs		



**PEDESTLS WITH TOP OVERHANG 600 mm WIDE**

	600	600	740	<b>KD663</b>		29.0	0.219	4		file drawer, universal overhang left/right; drawers depth - 500mm
	600	600	740	<b>KD664</b>		30.0	0.206	4		universal overhang left/right; drawers depth - 500mm
	600	800	740	<b>KD673</b>		36.0	0.273	4		file drawer, universal overhang left/right; drawers depth - 500mm
	600	800	740	<b>KD674</b>		37.0	0.273	4		universal overhang left/right; drawers depth - 500mm

**PEDESTLS WITH TOP OVERHANG 800 mm WIDE**

	800	600	740	<b>KD863</b>		31.0	0.223	4		file drawer, universal overhang left/right; drawers depth - 500mm
	800	600	740	<b>KD864</b>		32.0	0.211	4		universal overhang left/right; drawers depth - 500mm
	800	800	740	<b>KD873</b>		38.9	0.278	4		file drawer, universal overhang left/right; drawers depth: standard - 500mm, file - 700mm
	800	800	740	<b>KD874</b>		39.9	0.278	4		universal overhang left/right; drawers depth - 500mm

**ADDITIONAL CHARGE**



FEATURE	PRODUCT											COMMENTS
	KD663	KD664	KD673	KD674	KD863	KD864	KD873	KD874	kg	m3	pcs	
II PRICE GROUP									0.0	0.0000	0	
SELF CLOSING SYSTEM									1.0	0.0010	1	
BALL RUNNERS									1.0	0.0010	1	

DESCRIPTION





 - NET WEIGHT

 VOLUME





 NUMBER OF PACKAGES

PRODUCT ILLUSTRATION	DIMENSIONS [mm]			INDEX SYMBOL						COMMENTS
	WIDTH	DEPTH	HEIGHT			kg	m3	pcs		



PEDESTLS WITH TOP OVERHANG 1000 mm WIDE

	1000	600	740	<b>KD1063</b>		32.9	0.228	4		file drawer, universal overhang left/right; drawers depth - 500mm
	1000	600	740	<b>KD1064</b>		33.9	0.215	4		universal overhang left/right; drawers depth - 500mm
	1000	800	740	<b>KD1073</b>		41.9	0.284	4		file drawer, universal overhang left/right; drawers depth: standard - 500mm, file - 700mm
	1000	800	740	<b>KD1074</b>		42.9	0.284	4		universal overhang left/right; drawers depth - 500mm

PEDESTLS WITH TOP OVERHANG 1200 mm WIDE

	1200	600	740	<b>KD1263</b>		35.4	0.232	4		file drawer, universal overhang left/right; drawers depth - 500mm
	1200	600	740	<b>KD1264</b>		36.4	0.219	4		universal overhang left/right; drawers depth - 500mm
	1200	800	740	<b>KD1273</b>		44.9	0.290	4		file drawer, universal overhang left/right; drawers depth: standard - 500mm, file - 700mm
	1200	800	740	<b>KD1274</b>		45.9	0.290	4		universal overhang left/right; drawers depth - 500mm

ADDITIONAL CHARGE



FEATURE	PRODUCT											COMMENTS
	KD1063	KD1064	KD1073	KD1074	KD1263	KD1264	KD1273	KD1274	kg	m3	pcs	
II PRICE GROUP									0.0	0.0000	0	
SELF CLOSING SYSTEM									1.0	0.0010	1	
BALL RUNNERS									1.0	0.0010	1	

DESCRIPTION





 - NET WEIGHT

 VOLUME



 NUMBER OF PACKAGES

PRODUCT ILLUSTRATION	DIMENSIONS [mm]			INDEX SYMBOL						COMMENTS
	WIDTH	DEPTH	HEIGHT			kg	m3	pcs		

PEDESTALS WITHOUT TOPS

	400	600	712	<b>KDT063</b>		22.0	0.205	1		drawers depth - 500mm
	400	600	712	<b>KDT064</b>		23.0	0.193	1		drawers depth - 500mm
	400	800	712	<b>KDT073</b>		27.0	0.255	1		drawers depth: standard - 500mm, file - 700mm
	400	800	712	<b>KDT074</b>		28.0	0.255	1		drawers depth - 500mm

ADDITIONAL CHARGE

FEATURE	PRODUCT												COMMENTS
	KDT063	KDT064	KDT073	KDT074						kg	m3	pcs	
II PRICE GROUP										0.0	0.0000	0	
SELF CLOSING SYSTEM										1.0	0.0010	1	
BALL RUNNERS										1.0	0.0010	1	

DESCRIPTION

 - NET WEIGHT

 VOLUME

 NUMBER OF PACKAGES

TECHNICAL SPECIFICATION

COLOURS

TOP, BOTTOM



14 BEECH      26 ALUMINUM SATINATO      31 CANADIAN OAK      34 CHESTNUT      39 POLAR BIRCH



64 COCOA      67 WHITE PASTEL      106 LOWLAND NUT      154 ANTHRACITE



BODY - FIRST GROUP



26 ALUMINUM SATINATO      67 WHITE PASTEL      154 ANTHRACITE



BODY - SECOND GROUP



14 BEECH      31 CANADIAN OAK      34 CHESTNUT      39 POLAR BIRCH      64 COCOA



106 LOWLAND NUT



FRONT



14 BEECH      26 ALUMINUM SATINATO      31 CANADIAN OAK      34 CHESTNUT      39 POLAR BIRCH



64 COCOA      67 WHITE PASTEL      106 LOWLAND NUT      154 ANTHRACITE



PA1L - FABRIC NEMO



NE-1 BEIGE      NE-2 YELLOW      NE-3 ORANGE      NE-5 RED      NE-9 GREEN



NE-10 GREY      NE-14 DARK GREY      NE-15 NAVY BLUE      NE-16 BLACK      NE-17 BLUE



TECHNICAL SPECIFICATION

COLOURS

PA1L - FABRIC RUNNER - SECOND GROUP



PA1L - FABRIC MEDLEY - SECOND GROUP

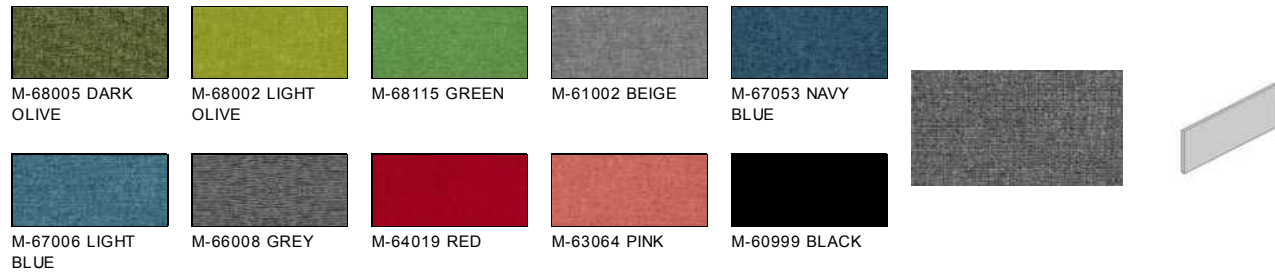

PA1L - FABRIC ATLANTIC - SECOND GROUP



PA1L - FABRIC SYNERGY - THIRD PRICE GROUP





## TECHNICAL SPECIFICATION

### COLOURS

#### PA1L - FABRIC XTREME - THIRD PRICE GROUP



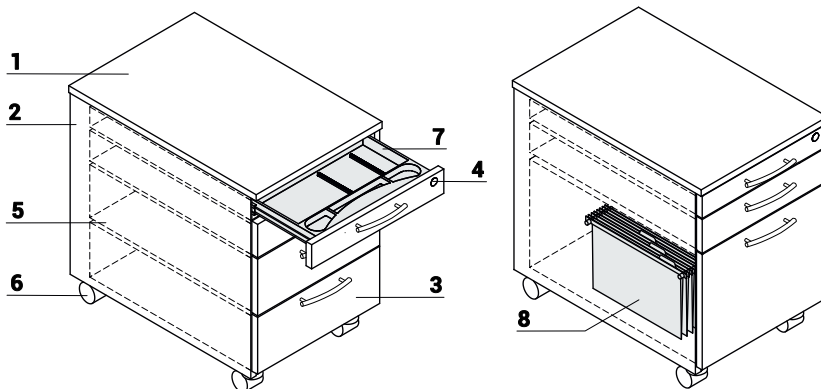

### KRT PEDESTALS



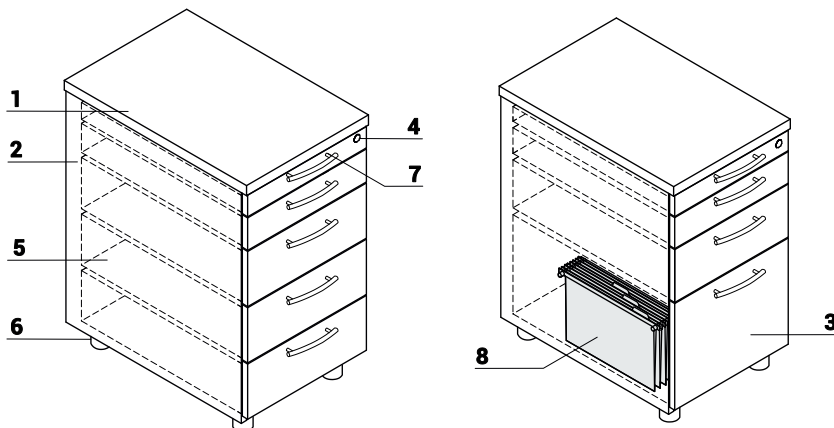







1. **Top** - MFC 18mm, PVC edge
2. **Body** - MFC 18mm, PVC edge
3. **Front** - MFC 18mm, PVC edge
4. **Central lock** - foldable key
5. **Metal drawer** - roll runners, max load 25kg, 80% extraction; Anti - tilt mechanism; OPTIONAL: ball runners, soft closing
6. **Castors** - Ø50mm, two with brakes
7. **Separate pencil drawer**
8. **Suspension files drawer** - ball runners, max load 30kg, 100% extraction  
A4 folders must be inserted parallelly to the front





1. **Top** - MFC 28mm, PVC edge
2. **Body** - MFC 18mm, PVC edge
3. **Front** - MFC 18mm, PVC edge
4. **Central lock** - foldable key
5. **Metal drawer** - roll runners, max load 25kg, 80% extraction; Anti - tilt mechanism; OPTIONAL: ball runners, soft closing
6. **Leveling** - 5mm range
7. **Separate pencil drawer**
8. **Suspension files drawer** - ball runners, max load 30kg, 100% extraction  
A4 folders must be inserted parallelly to the front

PRODUCT ILLUSTRATION	DIMENSIONS [mm]			INDEX SYMBOL						COMMENTS
	WIDTH	DEPTH	HEIGHT			kg	m3	pcs		

**KRT PEDESTALS**

	402	600	586	<b>KRT12</b>		31.0	0.151	1		mobile with suspension files drawer, drawers depth - 500mm
	402	600	586	<b>KRT13</b>		24.0	0.151	1		mobile; drawers depth - 500mm
	402	800	586	<b>KRT120</b>		27.0	0.198	1		mobile with suspension files drawer; drawers depth: standard - 500mm, file - 700mm
	402	800	586	<b>KRT130</b>		28.0	0.198	1		mobile; drawers depth - 500mm
	402	600	740	<b>KRT63</b>		28.0	0.211	1		file drawer; drawers depth - 500mm
	402	600	740	<b>KRT64</b>		29.0	0.211	1		drawers depth - 500mm
	402	800	740	<b>KRT73</b>		33.0	0.255	1		file drawer, universal overhang left/right; drawers depth: standard - 500mm, file - 700mm
	402	800	740	<b>KRT74</b>		33.0	0.255	1		drawers depth - 500mm

**ADDITIONAL CHARGE**



FEATURE	PRODUCT											COMMENTS
	KRT12	KRT13	KRT120	KRT130	KRT63	KRT64	KRT73	KRT74	kg	m3	pcs	
II PRICE GROUP									0.0	0.0000	0	
SELF CLOSING SYSTEM									1.0	0.0010	1	
BALL RUNNERS									1.0	0.0010	1	

DESCRIPTION



 - NET WEIGHT

 VOLUME



 NUMBER OF PACKAGES

PRODUCT ILLUSTRATION	DIMENSIONS [mm]			INDEX SYMBOL						COMMENTS
	WIDTH	DEPTH	HEIGHT			kg	m3	pcs		

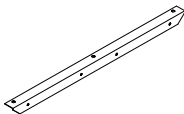
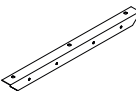

**COPPLEMENTARY ELEMENTS**

	800	402	389	<b>A1L02</b>		18.0	0.031	1		stack-on storage for pedestal
	800	402	389	<b>A1L04</b>		19.0	0.152	1		stack-on tambour storage for pedestal (with Lock), opens left to right
	761	341	22	<b>PA1L</b>		5.0	0.010	1		fabric screen for storage A1L02 or A1L04

**FIXING ELEMENTS**

	620	30	30	<b>E31</b>		0.6	0.001	1		angle bracket for 800mm edges
	450	30	30	<b>E32</b>		0.5	0.000	1		angle bracket for 600mm edges
	330	30	30	<b>E37</b>		1.5	0.000	1		angle bracket

**ADDITIONAL CHARGE**

FEATURE	PRODUCT													COMMENTS
	A1L02	A1L04	PA1L								kg	m3	pcs	
II PRICE GROUP											0.0	0.0000	0	
III PRICE GROUP											1.0	0.0010	1	

DESCRIPTION

 - NET WEIGHT

 VOLUME

 NUMBER OF PACKAGES



## TECHNICAL SPECIFICATION

### COLOURS

#### TOP, BOTTOM



26 ALUMINUM SATINATO



31 CANADIAN OAK



34 CHESTNUT



39 POLAR BIRCH



64 COCOA

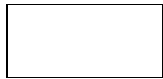

67 WHITE PASTEL



154 ANTHRACITE

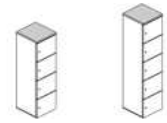

#### BODY



26 ALUMINUM SATINATO

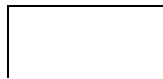

67 WHITE PASTEL



154 ANTHRACITE

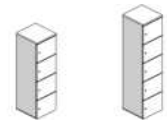

#### FRONT



26 ALUMINUM SATINATO



31 CANADIAN OAK



34 CHESTNUT



39 POLAR BIRCH



64 COCOA

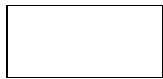

67 WHITE PASTEL



154 ANTHRACITE

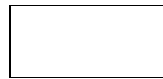

73 HIGH GLOSS WHITE



74 HIGH GLOSS ORANGE



80 HIGH GLOSS LIME



81 HIGH GLOSS BURGUNDY



102 HIGH GLOSS YELLOW



108 BLUE HIGH GLOSS



127 HIGH GLOSS FUCHSIA



148 HIGH GLOSS GRAY



101 HIGH GLOSS BLACK



155 ANTHRACITE HIGH GLOSS

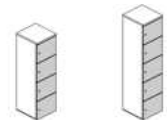

### LOCKER TYPE STORAGE

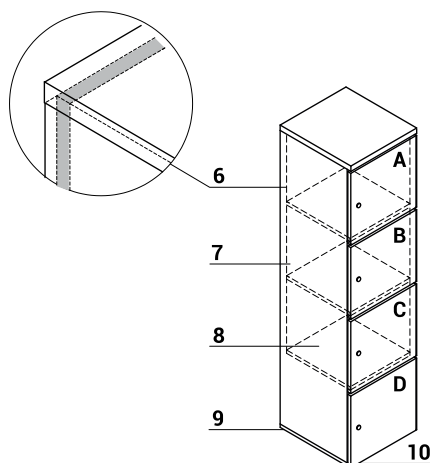

1. **Top** - MFC 28mm, PVC edge
2. **Opening gap for inserting sheets of paper** - gap of 17mm
3. **Internal dimensions of one segment** - 364x388x373mm
4. **Front** - MFC 18mm + HPL
5. **Patent lock** - OPTION WITH ADDITIONAL CHARGE: a code or digital lock
6. **Back MFC** - 18mm, PVC edges
7. **Side panels** - MFC 18mm, PVC edge
8. **Horizontal partition wall** - 18mm laminated board, edging of PVC
9. **Base** - MFC 18mm, PVC edge
10. **Leveling feet 27mm** - range 12mm
11. **Symbols** - important when choosing a colour, possible to choose front in various colors

TECHNICAL SPECIFICATION

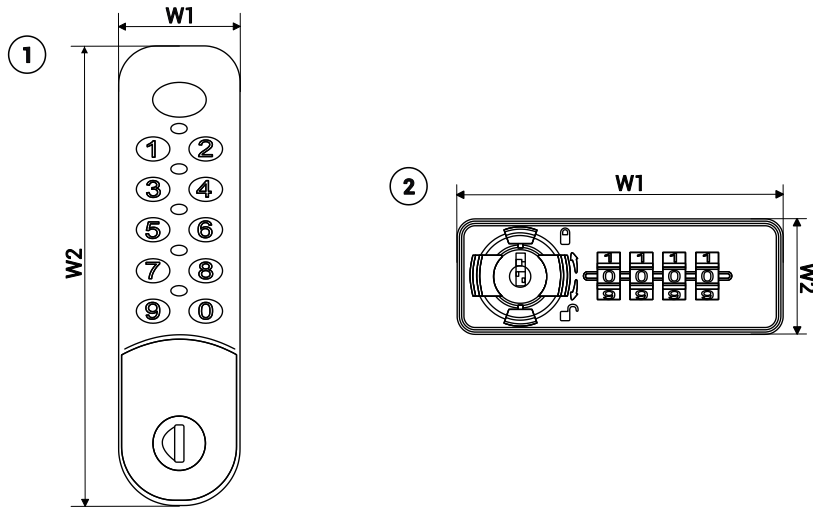

1. Standard Digital Combination Lock

- dimensions: W1 - 38mm | W2 - 136mm

\*High level of safety:

- 4 digit user codes

- 6 digit technical code meant for opening the cabinet without changing the code

- 6 digit Sub-Master code meant for opening and deleting user code

- 8 digit master code is used for setting the operating mode of the lock, resetting and deleting user code

\*Lock works in two modes (the possibility of ordering the lock of the selected mode)

- public mode (office, school)

- private mode (deposit, swimming pool, fitness clubs)

\* Ability to set an auto unlock after a specified period of time (only in private user mode)

\* Available versions designed especially for wet rooms (with additional seals) and a version for people with disabilities (adapted handle)

\* Lock comes complete with batteries and manual

2. Code lock

- dimensions: W1 - 73mm | W2 - 25mm

- code search function

- a straight bolt 32mm

PRODUCT ILLUSTRATION	DIMENSIONS [mm]			INDEX SYMBOL					COMMENTS
	WIDTH	DEPTH	HEIGHT			kg	m3	pcs	

LOCKER TYPE STORAGE

	400	432	1610	LOK04		41.5	0.088	3	
	400	432	2010	LOK05		49.5	0.105	3	

ADDITIONAL CHARGE

FEATURE	PRODUCT											COMMENTS
	LOK04	LOK05							kg	m3	pcs	
CODE LOCKS									0.9	0.0070	1	
ELECTRONIC LOCKS									0.9	0.0070	1	

DESCRIPTION

- NET WEIGHT

VOLUME

NUMBER OF PACKAGES

## TECHNICAL SPECIFICATION

### COLOURS

#### TOP, BOTTOM



#### BODY - FIRST GROUP

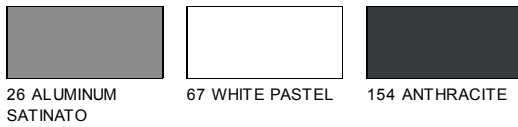

#### BODY - SECOND GROUP



#### FRONT



### CARGO PEDESTALS

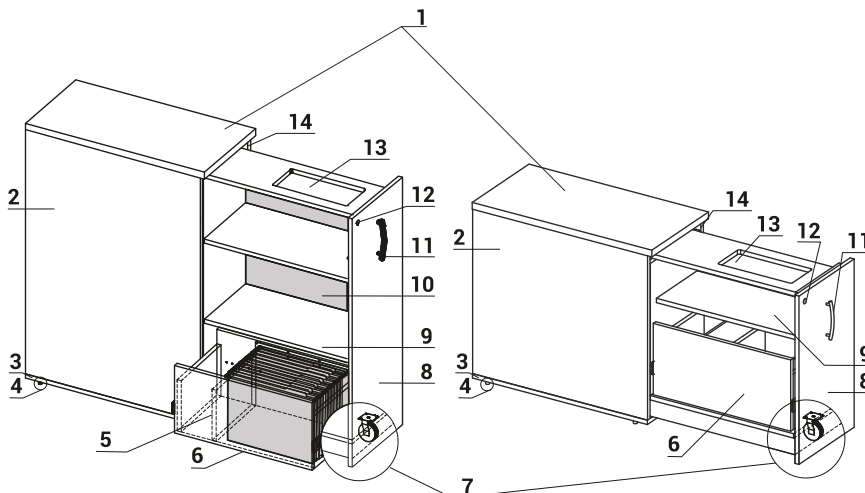

1. **Top** - MFC 28mm, PVC edge
2. **Body** - MFC 18mm, PVC edge
3. **Base** - MFC 18mm, PVC edge
4. **Leveling** - 10mm range
5. Movable vertical partition which allows organize the space
6. **Drawer** - MFC 18 mm, max. 35kg load, possible extraction 100%, possibility of hanging files, ball runners
7. **Castors** - Ø75mm
8. **Front** - MFC 18mm, PVC edge
9. **Shelf** - MFC 18mm, PVC edge
10. Back MFC – MFC 18 mm
11. **Aluminum handle**
12. **Patent lock**
13. **Pencil tray** - black plastic
14. **Back MFC** - 18mm, PVC edges

TECHNICAL SPECIFICATION

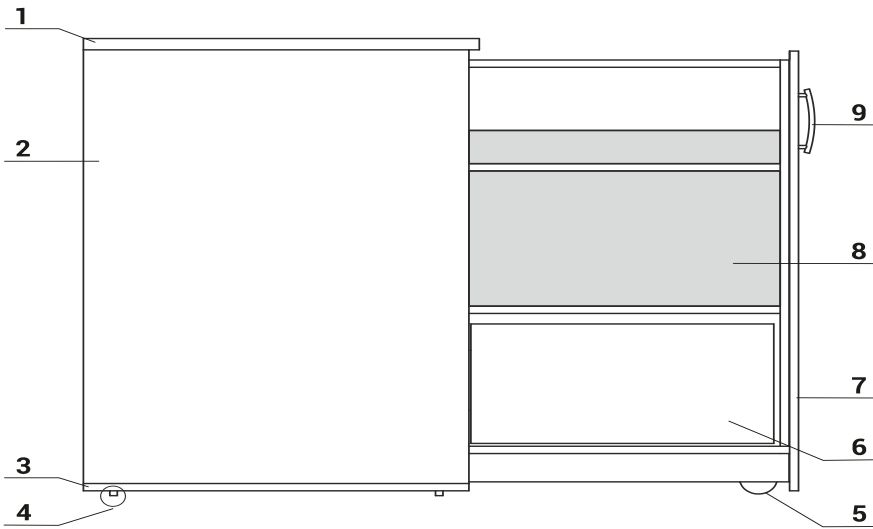

- 1. **Top** - MFC 28mm, PVC edge
- 2. **Body** - MFC 18mm, PVC edge
- 3. **Base** - MFC 18mm, PVC edge
- 4. **Leveling** - 10mm range
- 5. **Castors** - Ø75mm
- 6. **Drawer** - MFC 18 mm, max. 35kg load, possible extraction 100%, possibility of hanging files, ball runners
- 7. **Front** - MFC 18mm,PVC edge
- 8. **Back** MFC – MFC 18 mm
- 9. Aluminum handle

PRODUCT ILLUSTRATION	DIMENSIONS [mm]			INDEX SYMBOL						COMMENTS
	WIDTH	DEPTH	HEIGHT			kg	m3	pcs		

CARGO PEDESTALS

	402	800	1129	KCD81P		71.0	0.414	1		shelves accesable from right side
	402	800	1129	KCD81L		71.0	0.414	1		shelves accesable from left side
	402	800	740	KCN81P		50.0	0.275	1		shelves accesable from right side
	402	800	740	KCN81L		50.0	0.275	1		shelves accesable from left side

ADDITIONAL CHARGE

FEATURE	PRODUCT													COMMENTS
	KCD81P	KCD81L	KCN81P	KCN81L							kg	m3	pcs	
DRAWER											0.9	0.0070	1	
II PRICE GROUP											0.0	0.0000	0	

DESCRIPTION

- NET WEIGHT

VOLUME

NUMBER OF PACKAGES



TECHNICAL SPECIFICATION

COLOURS

A3R02



26 ALUMINUM SATINATO



67 WHITE PASTEL



154 ANTHRACITE



MOBILE STORAGE - MULTIFUNCTION

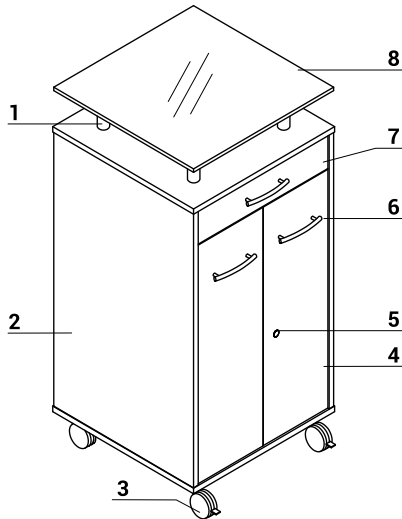

- 1. Spacers - 120mm
- 2. Body - MFC 18mm, PVC edge
- 3. Castors - Ø75mm, two with brakes
- 4. Front - MFC 18mm, PVC edge, plain hinge 110°
- 5. Patent lock
- 6. Aluminum handle
- 7. Drawer- 100% extraction, metal, max load 30kg, cutlery tray
- 8. Top - tempered frosted glass - 12mm; painted on bottom

PRODUCT ILLUSTRATION	DIMENSIONS [mm]			INDEX SYMBOL						COMMENTS
	WIDTH	DEPTH	HEIGHT							

MOBILE STORAGE - MULTIFUNCTION

	550	550	1188	A3R02		66.7	0.176	3		
--	-----	-----	------	-------	--	------	-------	---	--	--

DESCRIPTION

- NET WEIGHT

VOLUME

NUMBER OF PACKAGES



TECHNICAL SPECIFICATION

COLOURS

A120ML, A120MP, A14M - TOP, BOTTOM

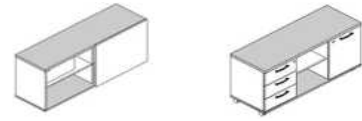

A12M - TOP



A120ML, A120MP, A14M - BODY - FIRST GROUP

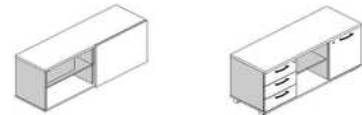
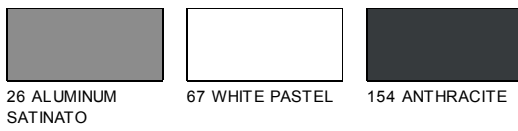

A120ML, A120MP, A14M - BODY - SECOND GROUP

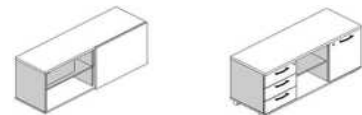

A120ML, A120MP, A14M, A12M - FRONT

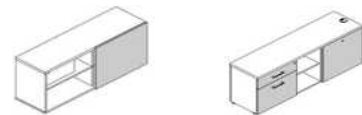

## TECHNICAL SPECIFICATION

### COLOURS

#### A12M - BOTTOM, BODY - FIRST GROUP

 26 ALUMINUM  
SATINATO

67 WHITE PASTEL



154 ANTHRACITE



#### A12M - BOTTOM, BODY - SECOND GROUP



14 BEECH



31 CANADIAN OAK



34 CHESTNUT



39 POLAR BIRCH



64 COCOA

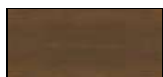

106 LOWLAND NUT



### MANAGERIAL STORAGE - A12M

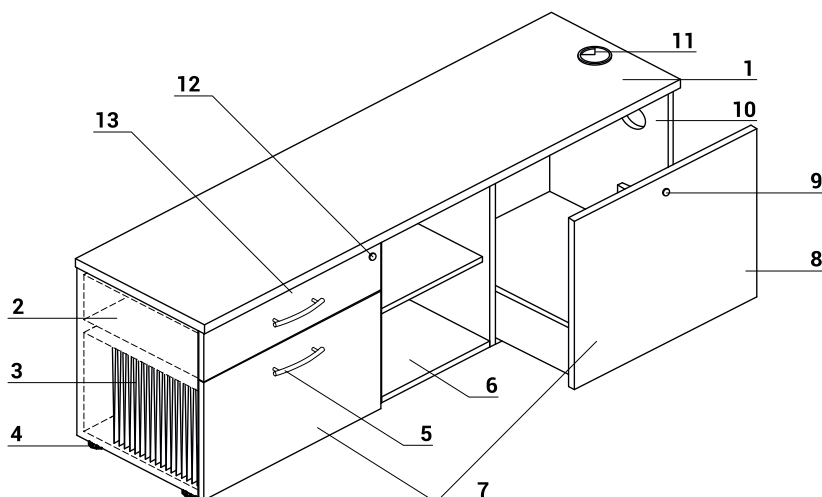

1. **Top** - MFC 28mm, PVC edge
2. **Metal drawer** - roll runners, max load 25kg, 80% extraction; Anti - tilt mechanism; OPTIONAL: ball runners, soft closing
3. **Suspension files drawer** - ball runners, max load 40kg, 100% extraction; push-to-open
4. **Leveling feet** - range 5mm
5. **Aluminum handle**
6. **Base** - MFC 18mm, PVC edge
7. **Front** - MFC 18mm, PVC edge
8. **Drawer with bottom** - ball runners, max. load 40kg, 100 % extraction, push to open (possible storage of computer)
9. **Central lock** - foldable key
10. **Body** - MFC 18mm, PVC edge
11. **Cable grommets** - Ø80mm
12. **Patent lock**
13. **Pencil tray** - black plastic

### MANAGERIAL STORAGE - A14M

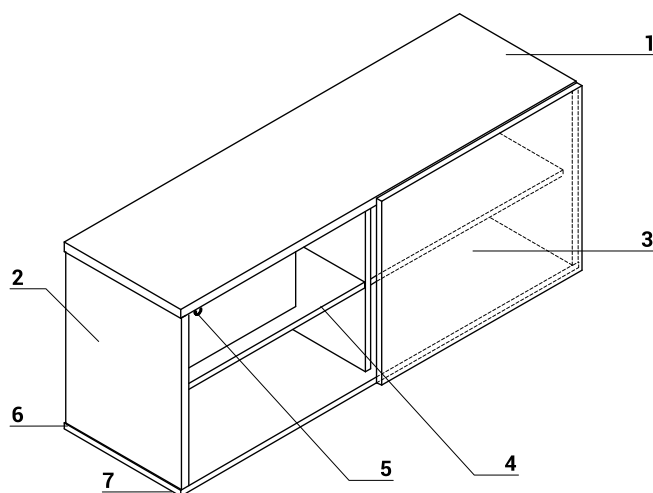

1. **Top** - MFC 28mm, PVC edge
2. **Side panels** - MFC 18mm, PVC edge
3. **Front** - MFC 18mm, PVC edge
4. **Shelf** - MFC 18mm, PVC edge
5. **Drawer** - MFC 18mm, PVC edge, lock - possible to change location
6. **Base** - MFC 18mm, PVC edge
7. **Leveling feet** - range 5mm

TECHNICAL SPECIFICATION

MANAGERIAL STORAGE - A120ML, A120MP

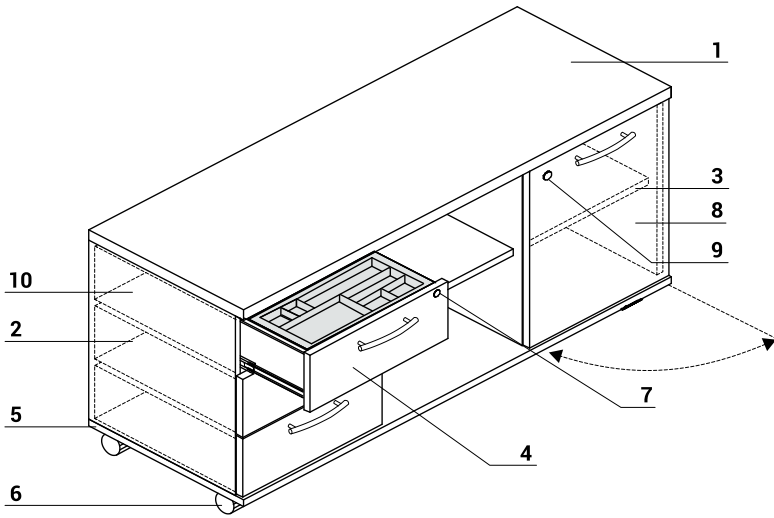

- 1. **Top** - MFC 28mm, PVC edge
- 2. **Side panels** - MFC 18mm, PVC edge
- 3. **Shelf** - MFC 18mm, PVC edge
- 4. **Pencil tray** - black plastic
- 5. **Base** - MFC 18mm, PVC edge
- 6. **Castors** - O50mm, two with brakes
- 7. **Patent lock**
- 8. **Front** - MFC 18mm,PVC edge, plain hinge 110°
- 9. **Central lock** - foldable key
- 10. **Metal drawer** - roll runners, max load 25kg, 80% extraction; Anti - tilt mechanism; OPTIONAL: ball runners

PRODUCT ILLUSTRATION	DIMENSIONS [mm]			INDEX SYMBOL						COMMENTS
	WIDTH	DEPTH	HEIGHT							

MANAGERIAL STORAGES

	1600	434	600	<b>A12M</b>		77.0	0.376	4		adjustable shelves
	1400	432	600	<b>A14M</b>		57.5	0.152	4		universal storage left or right, adjustable shelves
	1200	432	599	<b>A120ML</b>		0.0	0.001	0		
	1200	432	599	<b>A120MP</b>		0.0	0.001	0		

ADDITIONAL CHARGE

FEATURE	PRODUCT											COMMENTS
	A12M	A14M	A120ML	A120MP								
II PRICE GROUP									0.0	0.0000	0	

DESCRIPTION

- NET WEIGHT

VOLUME

NUMBER OF PACKAGES



TECHNICAL SPECIFICATION

COLOURS

ZS01 - TOP, BOTTOM, BODY



67 WHITE PASTEL

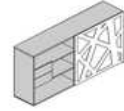

ZS01 - FRONT

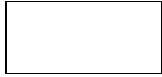

73 HIGH GLOSS WHITE

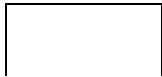

M015 WHITE SEMI-MATTE



ZS02 - TOP, BOTTOM, BODY

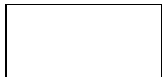

67 WHITE PASTEL



26 ALUMINUM SATINATO



154 ANTHRACITE

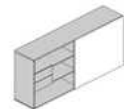

ZS02 - FRONT



73 HIGH GLOSS WHITE



74 HIGH GLOSS ORANGE



80 HIGH GLOSS LIME



81 HIGH GLOSS BURGUNDY



101 HIGH GLOSS BLACK



102 HIGH GLOSS YELLOW



108 BLUE HIGH GLOSS



127 HIGH GLOSS FUCHSIA



148 HIGH GLOSS GRAY



155 ANTHRACITE HIGH GLOSS

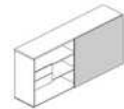

ZS03 - TOP, BOTTOM



14 BEECH



26 ALUMINUM SATINATO



31 CANADIAN OAK



34 CHESTNUT



39 POLAR BIRCH



64 COCOA



67 WHITE PASTEL

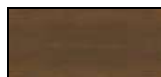

106 LOWLAND NUT



154 ANTHRACITE



ZS03 - BODY



67 WHITE PASTEL



26 ALUMINUM SATINATO



154 ANTHRACITE



## TECHNICAL SPECIFICATION

### COLOURS

#### ZS03 - FRONT



14 BEECH



26 ALUMINUM SATINATO



31 CANADIAN OAK



34 CHESTNUT



39 POLAR BIRCH



64 COCOA



67 WHITE PASTEL



106 LOWLAND NUT



154 ANTHRACITE

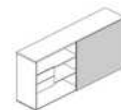

## MANAGERIAL STORAGE

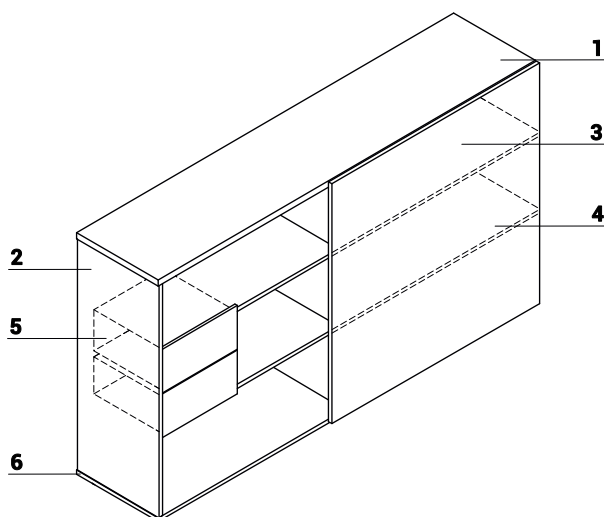

1. **Top** - MFC 28mm, PVC edge
2. **Side panels** - MFC 28mm, PVC edge
3. **Front** - sliding doors, metal self-closing mechanism, PVC edge
4. **Shelf** - MFC 18mm, PVC edge
5. **Drawer** - MFC 12mm, PVC edge, possible different position
6. **Base** - MFC 28mm, PVC edge

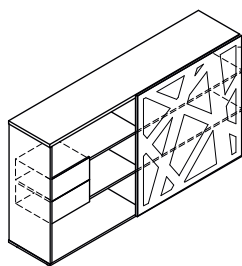

ZS01

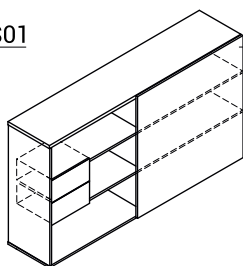

ZS02

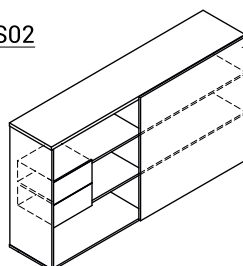

ZS03



**ZS01**  
HPL + powder coated steel

**ZS02**  
Front - HPL 18mm - high gloss, PVC edge



**ZS03**  
Front - MFC 18mm, PVC edge

Note: The front width 1100mm

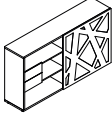
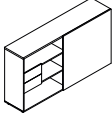
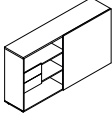

PRODUCT ILLUSTRATION	DIMENSIONS [mm]			INDEX SYMBOL						COMMENTS
	WIDTH	DEPTH	HEIGHT			kg	m3	pcs		

**MANAGERIAL STORAGE**

	2000	434	1129	<b>ZS01</b>		114.2	0.331	5		ZIG-ZAG front
	2000	434	1129	<b>ZS02</b>		122.2	0.331	5		HPL front
	2000	434	1129	<b>ZS03</b>		114.2	0.331	5		MFC front
	428	385	403	<b>ZSZ01</b>		10.2	0.075	1		additional drawer for storage ZS01, ZS02, ZS03

DESCRIPTION

 - NET WEIGHT

 VOLUME

 NUMBER OF PACKAGES



TECHNICAL SPECIFICATION

COLOURS

TOP, BOTTOM



14 BEECH



26 ALUMINUM SATINATO



31 CANADIAN OAK



34 CHESTNUT



39 POLAR BIRCH



64 COCOA

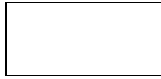

67 WHITE PASTEL



106 LOWLAND NUT



154 ANTHRACITE



BODY - FIRST GROUP



26 ALUMINUM SATINATO



67 WHITE PASTEL



154 ANTHRACITE

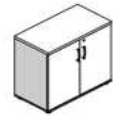

BODY - SECOND GROUP



14 BEECH



31 CANADIAN OAK



34 CHESTNUT



39 POLAR BIRCH



64 COCOA



106 LOWLAND NUT

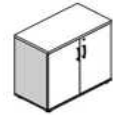

FRONT



14 BEECH



26 ALUMINUM SATINATO



31 CANADIAN OAK



34 CHESTNUT



39 POLAR BIRCH



64 COCOA



67 WHITE PASTEL

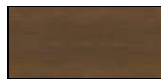

106 LOWLAND NUT



154 ANTHRACITE

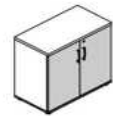

TECHNICAL SPECIFICATION

STORAGES

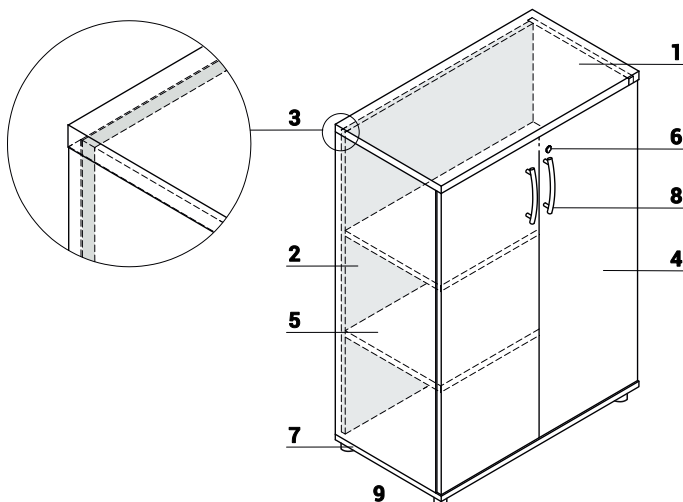

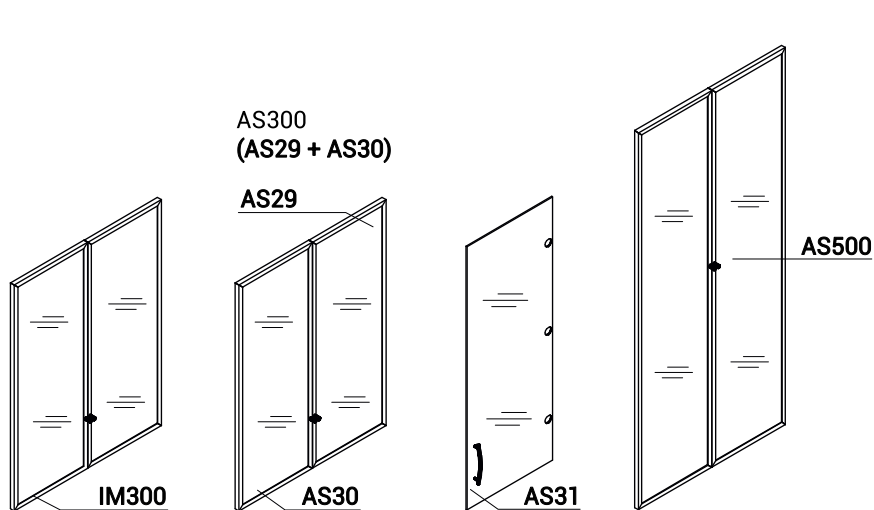

- 1. **Top** - MFC 28mm, PVC edge
- 2. **Side panels** - MFC 18mm, PVC edge
- 3. **Back MFC** - 18mm, PVC edges
- 4. **Front** - MFC 18 mm, PVC edges, plain hinge 110°
- 5. **Shelf** - MFC 18mm, PVC edge
- 6. **Patent lock**
- 7. **Base** - MFC 18mm, PVC edge
- 8. **Aluminum handle**
- 9. **Leveling feet 27mm** - range 12mm

ADDITIONAL ELEMENTS FOR STORAGE





- IM300**
- glass door 3OH
- transparent tempered glass 4mm, with aluminum frame
- AS300 (AS29+AS30)**
- AS29**
- Glass door 3OH
- frosted tempered glass 4mm, with aluminum frame Right
- AS30**
- Glass door 3OH
- frosted tempered glass 4mm, with aluminum frame Left
- AS31**
- Glass door 3OH
- transparent tempered glass 4mm
- universal (left,right)
- AS500**
- Glass door 5OH
- transparent tempered glass 4mm, with aluminum frame

PRODUCT ILLUSTRATION	DIMENSIONS [mm]			INDEX SYMBOL						COMMENTS
	WIDTH	DEPTH	HEIGHT			kg	m3	pcs		

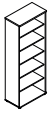
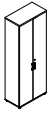
60H STORAGE 800 mm WIDE

	801	432	2185	<b>A6504</b>		67.0	0.167	2		
	801	432	2185	<b>A6104</b>		88.0	0.224	3		OPTIONAL: espagnolette lock - additional fee

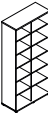

60H STORAGE 1000 mm WIDE

	1000	432	2185	<b>A6505</b>		86.0	0.184	2		
	1000	432	2185	<b>A6105</b>		112.0	0.255	3		espagnolette lock

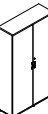
60H STORAGE 1200 mm WIDE

	1200	432	2185	<b>A6506</b>		98.0	0.219	2		
	1200	432	2185	<b>A6106</b>		128.0	0.303	3		espagnolette lock

ADDITIONAL CHARGE



FEATURE	PRODUCT									COMMENTS
	A6504	A6104	A6505	A6105	A6506	A6106	kg	m3	pcs	
ESPAÑOLETTE LOCK							0.1	0.0001	1	
II PRICE GROUP							0.0	0.0000	0	
ANGLE HINGE 170°							1.0	0.0010	1	

DESCRIPTION



 - NET WEIGHT

 VOLUME





 NUMBER OF PACKAGES

PRODUCT ILLUSTRATION	DIMENSIONS [mm]			INDEX SYMBOL						COMMENTS
	WIDTH	DEPTH	HEIGHT			kg	m3	pcs		



50H STORAGE 400 mm WIDE

	402	432	1833	<b>A5902</b>		38.0	0.083	2		
	402	432	1833	<b>A58P2</b>		40.0	0.096	2		right door
	402	432	1833	<b>A56P2</b>		45.0	0.096	2		right door, OPTIONAL: espagnolette lock - additional fee

50H STORAGE 800 mm WIDE

	801	432	1833	<b>A5504</b>		58.0	0.167	2		
	801	432	1833	<b>A5404</b>		65.0	0.187	3		
	801	432	1833	<b>A5304</b>		69.3	0.194	3		
	801	432	1833	<b>A5104</b>		76.7	0.209	3		OPTIONAL: espagnolette lock - additional fee
	802	802	1833	<b>A5NP4</b>		0.0	0.001	0		Corner storage, espagnolette lock

ADDITIONAL CHARGE



FEATURE	PRODUCT												COMMENTS
	A5902	A58P2	A56P2	A5504	A5404	A5304	A5104	A5NP4		kg	m3	pcs	
ESPAÑOLETTE LOCK										0.1	0.0001	1	
II PRICE GROUP										0.0	0.0000	0	
ANGLE HINGE 170°										1.0	0.0010	1	

DESCRIPTION

 - NET WEIGHT

 VOLUME

 NUMBER OF PACKAGES

PRODUCT ILLUSTRATION	DIMENSIONS [mm]			INDEX SYMBOL						COMMENTS
	WIDTH	DEPTH	HEIGHT			kg	m3	pcs		

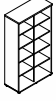
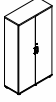

5OH STORAGES 1000 mm WIDE

	1000	432	1833	<b>A5505</b>		74.0	0.159	2		
	1000	432	1833	<b>A5105</b>		95.0	0.219	3		espagnolette lock

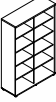
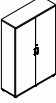

5OH STORAGES 1200 mm WIDE

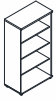
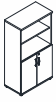
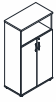
	1200	432	1833	<b>A5506</b>		83.0	0.185	2		
	1200	432	1833	<b>A5106</b>		108.0	0.256	3		espagnolette lock

4OH STORAGES 800 mm WIDE

	801	432	1481	<b>A4504</b>		47.0	0.114	2		
	801	432	1481	<b>A4404</b>		54.0	0.134	3		
	801	432	1481	<b>A4304</b>		58.3	0.140	3		
	801	432	1481	<b>A4104</b>		60.0	0.147	3		

ADDITIONAL CHARGE



FEATURE	PRODUCT												COMMENTS
	A5505	A5105	A5506	A5106	A4504	A4404	A4304	A4104		kg	m3	pcs	
II PRICE GROUP										0.0	0.0000	0	
ANGLE HINGE 170°										1.0	0.0010	1	

DESCRIPTION

 - NET WEIGHT

 VOLUME



 NUMBER OF PACKAGES

PRODUCT ILLUSTRATION	DIMENSIONS [mm]			INDEX SYMBOL						COMMENTS
	WIDTH	DEPTH	HEIGHT			kg	m3	pcs		



40H STORAGE 1200 mm WIDE

	1200	432	1481	<b>A4506</b>		59.0	0.167	2		
---	------	-----	------	--------------	--	------	-------	---	--	--



30H STORAGES 400 mm WIDE

	402	432	1129	<b>A3902</b>		24.0	0.059	2		
	402	432	1129	<b>A38P2</b>		28.0	0.063	2		right door
	402	432	1129	<b>A36P2</b>		29.0	0.064	2		right door

30H STORAGES 800 mm WIDE

	801	432	1129	<b>A3504</b>		33.0	0.089	2		
	801	432	1129	<b>A3404</b>		40.0	0.109	3		
	801	432	1129	<b>A3104</b>		44.3	0.116	3		

ADDITIONAL CHARGE

FEATURE	PRODUCT											COMMENTS
	A4506	A3902	A38P2	A36P2	A3504	A3404	A3104		kg	m3	pcs	
II PRICE GROUP									0.0	0.0000	0	
ANGLE HINGE 170°									1.0	0.0010	1	



DESCRIPTION

 - NET WEIGHT



 VOLUME

 NUMBER OF PACKAGES





PRODUCT ILLUSTRATION	DIMENSIONS [mm]			INDEX SYMBOL						COMMENTS
	WIDTH	DEPTH	HEIGHT			kg	m3	pcs		

3OH STORAGES 1000 mm WIDE

	1000	432	1129	A3505		48.0	0.100	2		
	1000	432	1129	A3105		61.0	0.138	3		



3OH STORAGES 1200 mm WIDE

	1200	432	1129	A3506		54.0	0.119	2		
	1200	432	1129	A3106		69.0	0.164	3		

3OH STORAGE 1600 mm WIDE

	1600	432	1129	A3508		69.0	0.147	2		
--	------	-----	------	-------	--	------	-------	---	--	--

ADDITIONAL CHARGE



FEATURE	PRODUCT												COMMENTS
	A3505	A3105	A3506	A3106	A3508					kg	m3	pcs	
II PRICE GROUP										0.0	0.0000	0	
ANGLE HINGE 170°										1.0	0.0010	1	

DESCRIPTION









 - NET WEIGHT

 VOLUME



 NUMBER OF PACKAGES

PRODUCT ILLUSTRATION	DIMENSIONS [mm]			INDEX SYMBOL						COMMENTS
	WIDTH	DEPTH	HEIGHT			kg	m3	pcs		

20H STORAGES

	402	432	777	<b>A2902</b>		18.0	0.041	2		
	402	432	777	<b>A26P2</b>		21.0	0.048	2		right door
	801	432	777	<b>A2504</b>		28.0	0.071	2		
	801	432	777	<b>A2104</b>		35.0	0.091	3		
	1200	432	777	<b>A2506</b>		43.0	0.104	2		
	1600	432	777	<b>A2508</b>		51.0	0.118	2		
	801	432	740	<b>A25B4</b>		27.0	0.071	2		
	801	432	740	<b>A21B4</b>		33.5	0.090	3		

ADDITIONAL CHARGE



FEATURE	PRODUCT												COMMENTS
	A2902	A26P2	A2504	A2104	A2506	A2508	A25B4	A21B4		kg	m3	pcs	
II PRICE GROUP										0.0	0.0000	0	
ANGLE HINGE 170°										1.0	0.0010	1	

DESCRIPTION





 - NET WEIGHT

 VOLUME

 NUMBER OF PACKAGES

PRODUCT ILLUSTRATION	DIMENSIONS [mm]			INDEX SYMBOL						COMMENTS
	WIDTH	DEPTH	HEIGHT			kg	m3	pcs		



**2 OH STACK-ON STORAGES**

	402	432	750	<b>A1902</b>		18.0	0.041	2		
	402	432	750	<b>A16P2</b>		21.0	0.048	2		right door
	801	432	750	<b>A1504</b>		23.0	0.052	2		
	801	432	750	<b>A1104</b>		30.0	0.072	3		
	802	802	750	<b>A1NP4</b>		0.0	0.001	0		Corner storage

**PRINTER STORAGE**

	710	600	600	<b>S85</b>		32.0	0.066	1		under printer storage, all in 26-aluminum satinato or 67-white pastel or 154-anthracite
---	-----	-----	-----	------------	--	------	-------	---	--	---

**ADDITIONAL CHARGE**



FEATURE	PRODUCT												COMMENTS
	A1902	A16P2	A1504	A1104	A1NP4					kg	m3	pcs	
II PRICE GROUP										0.0	0.0000	0	
ANGLE HINGE 170°										1.0	0.0010	1	

DESCRIPTION









 - NET WEIGHT

 VOLUME

 NUMBER OF PACKAGES

PRODUCT ILLUSTRATION	DIMENSIONS [mm]			INDEX SYMBOL						COMMENTS
	WIDTH	DEPTH	HEIGHT			kg	m3	pcs		

**ADDITIONAL ELEMENTS FOR STORAGE**

	397	5	1050	<b>AS31</b>		6.5	0.034	1		universal glass door (1pcs) 3OH, transparent tempered glass
	397	20	1050	<b>AS29</b>		5.0	0.022	1		right glass door (1pcs) 3OH with aluminum frame, frosted tempered glass
	397	20	1050	<b>AS30</b>		5.0	0.022	1		left glass door (1pcs) 3OH aluminum frame, frosted tempered glass
	800	20	1050	<b>AS300</b>		10.3	0.037	1		glass doors (2pcs) 3OH aluminum frame, frosted tempered glass
	800	20	1050	<b>IM300</b>		10.0	0.039	1		glass doors (2pcs) 3OH aluminum frame, transparent tempered glass
	400	20	1050	<b>IM30L</b>		5.0	0.030	1		glass doors (1pcs) 3OH aluminum frame, transparent tempered glass
	400	20	1050	<b>IM30P</b>		5.0	0.030	1		glass doors (1pcs) 3OH aluminum frame, transparent tempered glass
	800	20	1754	<b>AS500</b>		16.0	0.065	1		glass doors (2pcs) 5OH aluminum frame, transparent tempered glass

DESCRIPTION

 - NET WEIGHT

 VOLUME

 NUMBER OF PACKAGES

## TECHNICAL SPECIFICATION

### COLOURS

#### TOP, BOTTOM



14 BEECH



26 ALUMINUM  
SATINATO



31 CANADIAN OAK



34 CHESTNUT



39 POLAR BIRCH



64 COCOA



67 WHITE PASTEL



106 LOWLAND NUT



154 ANTHRACITE



#### BODY - FIRST GROUP



26 ALUMINUM  
SATINATO



67 WHITE PASTEL



154 ANTHRACITE



#### BODY - SECOND GROUP



14 BEECH



31 CANADIAN OAK



34 CHESTNUT



39 POLAR BIRCH



64 COCOA



106 LOWLAND NUT



#### FRONT



14 BEECH



26 ALUMINUM  
SATINATO



31 CANADIAN OAK



34 CHESTNUT



39 POLAR BIRCH



64 COCOA

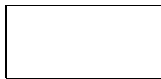

67 WHITE PASTEL

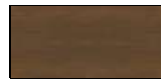

106 LOWLAND NUT



154 ANTHRACITE



TECHNICAL SPECIFICATION

WARDROBES

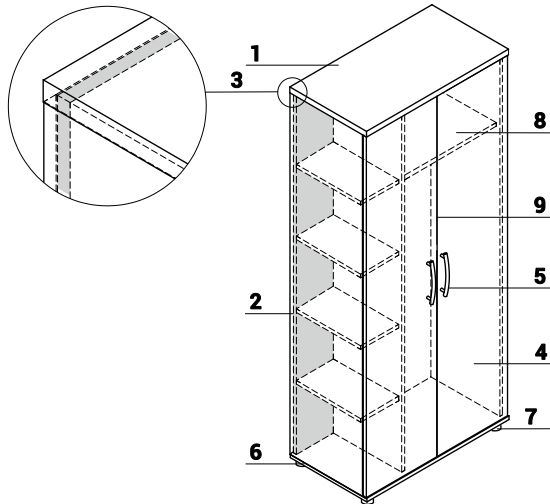

- 1. **Top** - MFC 28mm, PVC edge
- 2. **Side panels** - MFC 18mm, PVC edge
- 3. **Back MFC** - 18mm, PVC edges
- 4. **Front** - MFC 18 mm, PVC edges, plain hinge 110°
- 5. **Aluminum handle**
- 6. **Base** - MFC 18mm, PVC edge
- 7. **Leveling feet 27mm** - range 12mm
- 8. **Shelf** - MFC 18mm, PVC edge
- 9. **Option with additional charge** - espagnolette lock

A57P3\*\*

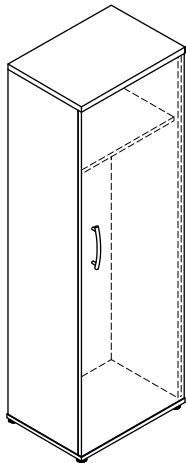

A52P4\*\*

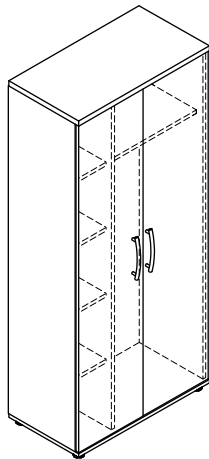

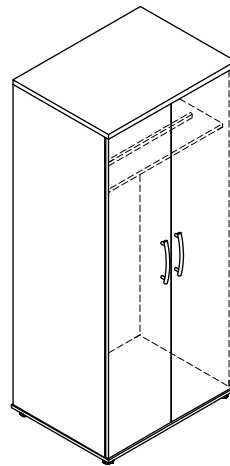

A6204\*



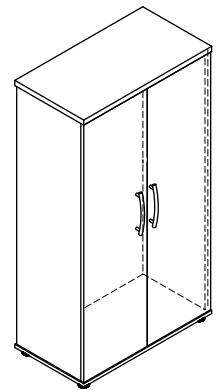



A4204\*\*



\* Coat rod \*\* Slide-out hanger

PRODUCT ILLUSTRATION	DIMENSIONS [mm]			INDEX SYMBOL						COMMENTS
	WIDTH	DEPTH	HEIGHT			kg	m3	pcs		



**WARDROBES**

	602	432	1833	<b>A57P3</b>		52.0	0.135	2		wardrobe with slide out hanger; OPTIONAL: espagnolette lock
	801	600	1833	<b>A6204</b>		72.0	0.191	3		wardrobe with coat rod, OPTIONAL: espagnolette lock
	801	432	1833	<b>A52P4</b>		76.0	0.215	3		wardrobe with slide out hanger, 4 OH; OPTIONAL: espagnolette lock
	802	432	1481	<b>A4204</b>		50.0	0.122	3		wardrobe with slide out hanger; OPTIONAL: espagnolette lock

**2 OH STACK-ON STORAGES**

	602	432	750	<b>A16P3</b>		27.0	0.067	2		
--	-----	-----	-----	--------------	--	------	-------	---	--	--

**ADDITIONAL CHARGE**

FEATURE	PRODUCT									COMMENTS
	A57P3	A6204	A52P4	A4204	A16P3		kg	m3	pcs	
ESPAÑOLETTE LOCK							0.1	0.0001	1	
II PRICE GROUP							0.0	0.0000	0	
ANGLE HINGE 170°							1.0	0.0010	1	

DESCRIPTION

 - NET WEIGHT

 VOLUME

 NUMBER OF PACKAGES





TECHNICAL SPECIFICATION

COLOURS

TOP, BOTTOM

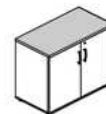
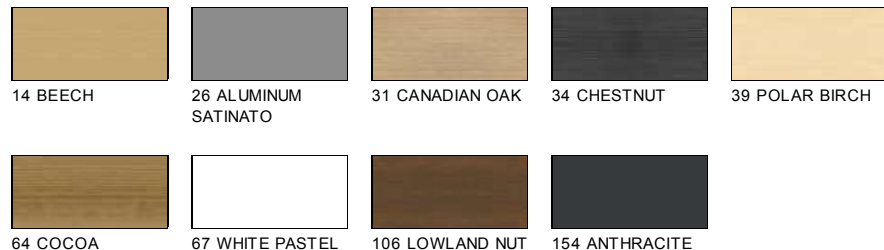

BODY - FIRST GROUP

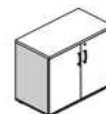
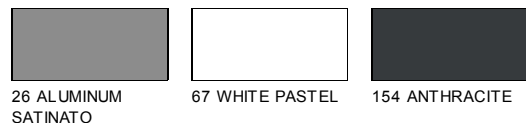

BODY - SECOND GROUP

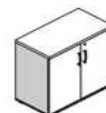

FRONT - STORAGES AND FILING CABINETS WITH METAL SHELVES

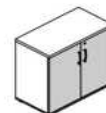
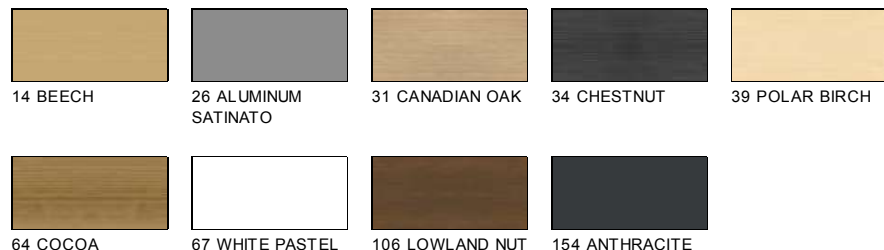

FRONT - FILING DRAWERS CABINETS

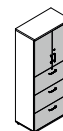

TECHNICAL SPECIFICATION

STORAGES AND FILING CABINETS WITH METAL SHELVES

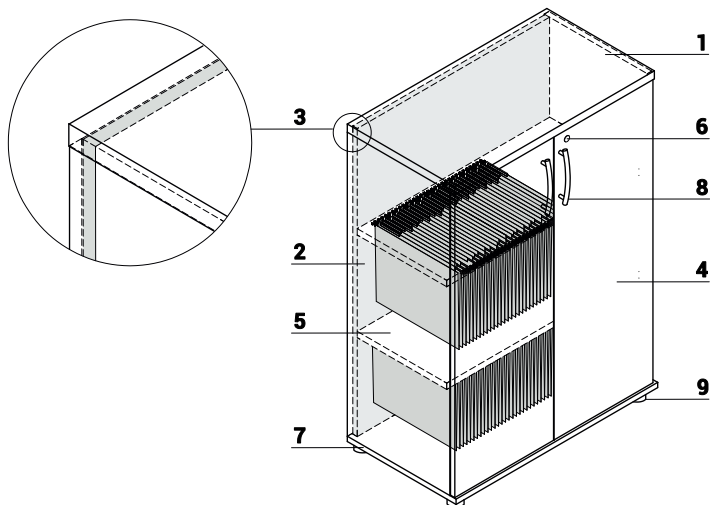

1. **Top** - MFC 28mm, PVC edge
2. **Side panels** - MFC 18mm, PVC edge
3. **Back MFC** - 18mm, PVC edges
4. **Front** - MFC 18 mm, PVC edges, plain hinge 110°
5. **Metal shelf with possibility of using suspension files** - max load 41kg, colour: M009 - aluminum semi-matte
6. **Patent lock**
7. **Base** - MFC 18mm, PVC edge
8. **Aluminum handle**
9. **Leveling feet 27mm** - range 12mm

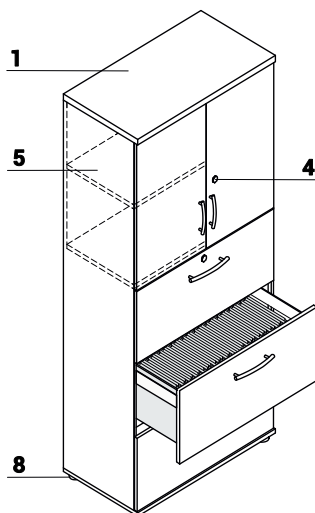
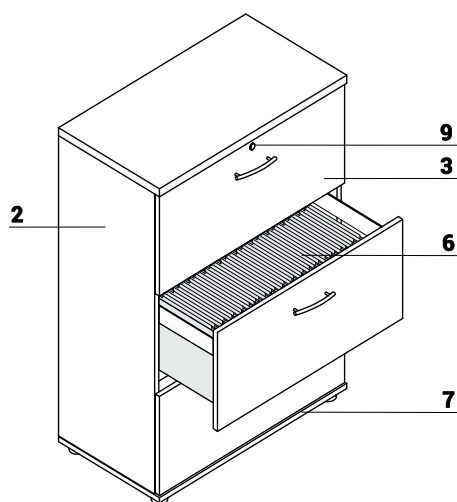

1. **Top** - MFC 28mm, PVC edge
2. **Side panels** - MFC 18mm, PVC edge
3. **Front** - MFC 18 mm, PVC edges, plain hinge 110°
4. **Patent lock**
5. **Shelf** - MFC 18mm, PVC edge
6. **Suspension files drawer** - metal frame, ball runners, max load 55kg, 100% extraction
7. **Base** - MFC 18mm, PVC edge
8. **Leveling feet 27mm** - range 12mm
9. **Espagnolet lock**
10. Possibility to place suspension files of A4 size

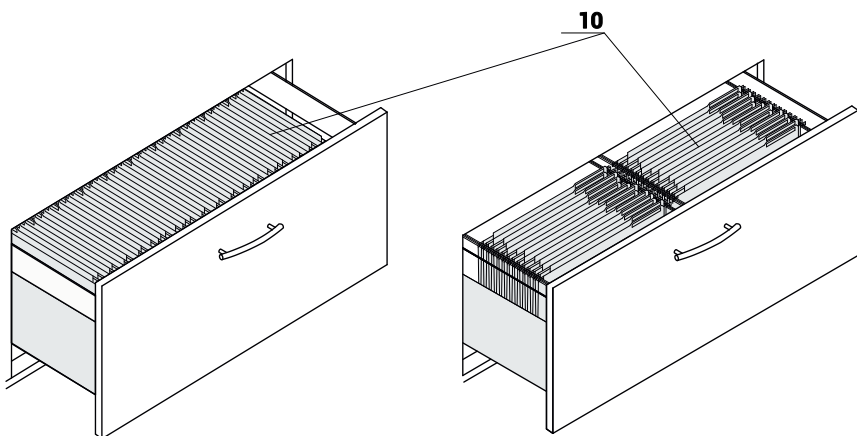



## TECHNICAL SPECIFICATION

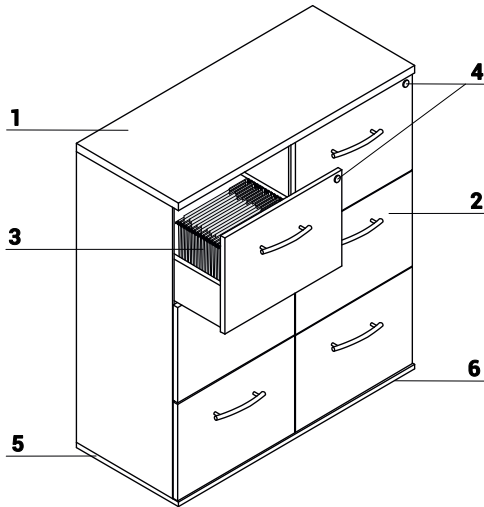







### STORAGES AND FILING CABINETS WITH METAL SHELVES





1. **Top** - MFC 28mm, PVC edge
2. **Front** - MFC 18mm,PVC edge
3. **Suspension files drawer** - MFC 18mm, ball runners, max load 45kg, 100% extraction
4. **Central lock** - foldable key
5. **Base** - MFC 18mm, PVC edge
6. **Leveling feet 27mm** - range 12mm

PRODUCT ILLUSTRATION	DIMENSIONS [mm]			INDEX SYMBOL						COMMENTS
	WIDTH	DEPTH	HEIGHT			kg	m3	pcs		

STORAGES AND FILING CABINETS WITH METAL SHELVES

	801	432	1129	A3504TM		36.0	0.091	2		3 metal shelves
	801	432	1129	A3104TM		47.3	0.118	3		2 metal shelves
	1000	432	1129	A3505TM		39.0	0.100	2		2 metal shelves
	1000	432	1129	A3105TM		52.0	0.138	3		2 metal shelves
	1200	432	1129	A3506TM		46.0	0.127	2		2 metal shelves
	1200	432	1129	A3106TM		61.0	0.172	3		2 metal shelves
	801	432	1833	A5504TM		55.0	0.167	2		4 metal shelves
	801	432	1833	A5104TM		72.0	0.215	3		4 metal shelves, espagnolette lock
	1000	432	1833	A5505TM		59.0	0.158	2		4 metal shelves

ADDITIONAL CHARGE



FEATURE	PRODUCT													COMMENTS
	A3504TM	A3104TM	A3505TM	A3105TM	A3506TM	A3106TM	A5504TM	A5104TM	A5505TM		kg	m3	pcs	
II PRICE GROUP											0.0	0.0000	0	
ANGLE HINGE 170°											1.0	0.0010	1	

DESCRIPTION

 - NET WEIGHT

 VOLUME



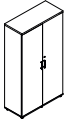
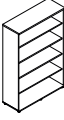
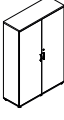

 NUMBER OF PACKAGES

PRODUCT ILLUSTRATION	DIMENSIONS [mm]			INDEX SYMBOL						COMMENTS
	WIDTH	DEPTH	HEIGHT			kg	m3	pcs		

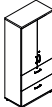
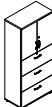

STORAGES AND FILING CABINETS WITH METAL SHELVES

	1000	432	1833	A5105TM		80.0	0.218	3		4 metal shelves, espagnolette lock
	1200	432	1833	A5506TM		66.0	0.218	2		4 metal shelves
	1200	432	1833	A5106TM		91.0	0.289	3		4 metal shelves, espagnolette lock

FILING DRAWERS CABINETS

	801	432	1129	A3F04		52.7	0.421	1		suspension file drawers without - open bottom
	1000	432	1129	A6F04		87.0	0.528	1		suspension file drawers with bottom
	801	432	1833	A54B4		74.1	0.684	1		suspension file drawers without - open bottom, MFC shelf
	801	432	1833	A54C4		70.5	0.684	1		suspension file drawers without - open bottom, MFC shelf
	801	432	1833	A54D4		74.1	0.684	1		suspension file drawers without - open bottom, MFC shelf
	801	432	1833	A54E4		70.5	0.684	1		suspension file drawers without - open bottom, MFC shelf

ADDITIONAL CHARGE

FEATURE	PRODUCT													COMMENTS
	A5105TM	A5506TM	A5106TM	A3F04	A6F04	A54B4	A54C4	A54D4	A54E4		kg	m3	pcs	
II PRICE GROUP											0.0	0.0000	0	
ANGLE HINGE 170°											1.0	0.0010	1	

DESCRIPTION

 - NET WEIGHT

 VOLUME

 NUMBER OF PACKAGES



## TECHNICAL SPECIFICATION

### COLOURS

#### TOP, BOTTOM



#### BODY - FIRST GROUP

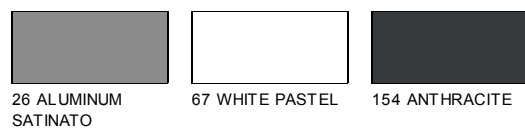

#### BODY - SECOND GROUP



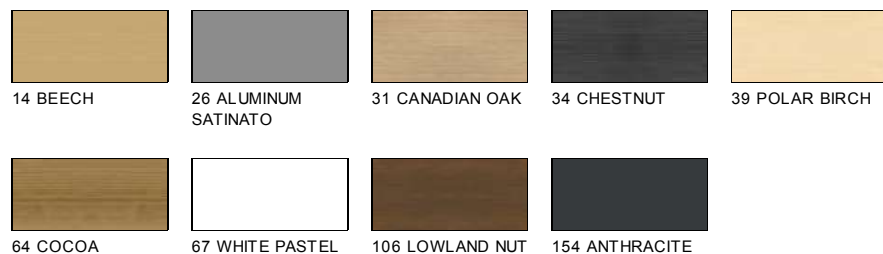

#### FRONT



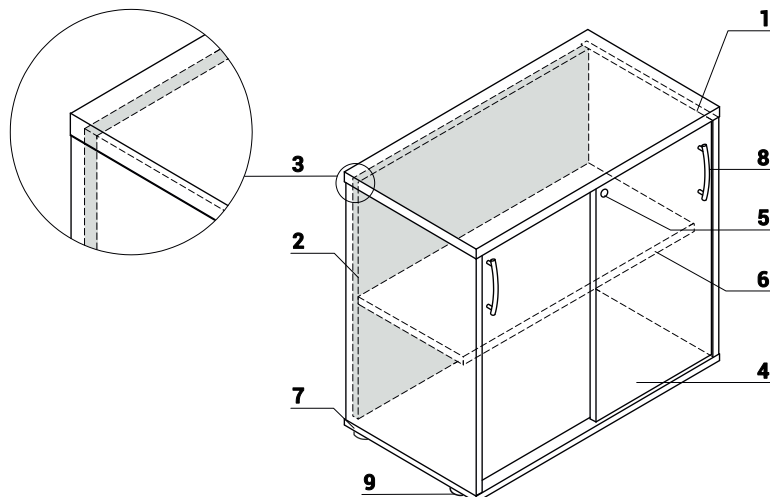







### SLIDING DOOR STORAGES





1. **Top** - MFC 28mm, PVC edge
2. **Side panels** - MFC 18mm, PVC edge
3. **Back MFC** - 18mm, PVC edges
4. **Sliding front** - MFC 18mm, PVC edge
5. **Patent lock**
6. **Shelf** - MFC 18mm, PVC edge
7. **Base** - MFC 18mm, PVC edge
8. **Aluminum handle**
9. **Leveling feet 27mm** - range 12mm
10. **Option with additional charge** - soft-closing system

PRODUCT ILLUSTRATION	DIMENSIONS [mm]			INDEX SYMBOL						COMMENTS
	WIDTH	DEPTH	HEIGHT			kg	m3	pcs		

SLIDING DOOR STORAGES

	800	432	740	<b>A2P04</b>		35.0	0.092	3		
	1000	432	740	<b>A2P05</b>		40.5	0.109	3		
	1200	432	740	<b>A2P06</b>		41.0	0.120	3		
	1600	432	740	<b>A2P08</b>		64.0	0.152	3		
	1610	432	740	<b>A2P16</b>		64.0	0.154	3		
	800	432	1129	<b>A3P04</b>		48.0	0.126	3		
	1000	432	1129	<b>A3P05</b>		61.0	0.146	3		
	1200	432	1129	<b>A3P06</b>		75.0	0.174	3		
	1600	432	1129	<b>A3P08</b>		89.0	0.230	3		

ADDITIONAL CHARGE

FEATURE	PRODUCT													COMMENTS
	A2P04	A2P05	A2P06	A2P08	A2P16	A3P04	A3P05	A3P06	A3P08		kg	m3	pcs	
II PRICE GROUP											0.0	0.0000	0	
SELF CLOSING SYSTEM											1.0	0.0010	1	

DESCRIPTION

 - NET WEIGHT

 VOLUME

 NUMBER OF PACKAGES



PRODUCT ILLUSTRATION	DIMENSIONS [mm]			INDEX SYMBOL						COMMENTS
	WIDTH	DEPTH	HEIGHT			kg	m3	pcs		

## SLIDING DOOR STORAGES

	1610	432	1129	<b>A3P16</b>		89.0	0.234	3		
	800	432	1481	<b>A4P04</b>		60.0	0.158	3		
	1000	432	1481	<b>A4P05</b>		77.0	0.183	3		
	1200	432	1481	<b>A4P06</b>		89.0	0.218	3		
	800	432	1833	<b>A5P04</b>		73.0	0.205	3		
	1000	432	1833	<b>A5P05</b>		92.0	0.219	3		
	1200	432	1833	<b>A5P06</b>		103.0	0.260	3		

## ADDITIONAL CHARGE



FEATURE	PRODUCT											COMMENTS
	A3P16	A4P04	A4P05	A4P06	A5P04	A5P05	A5P06		kg	m3	pcs	
II PRICE GROUP									0.0	0.0000	0	
SELF CLOSING SYSTEM									1.0	0.0010	1	

DESCRIPTION



- NET WEIGHT

VOLUME



NUMBER OF PACKAGES

PRODUCT ILLUSTRATION	DIMENSIONS [mm]			INDEX SYMBOL						COMMENTS
	WIDTH	DEPTH	HEIGHT			kg	m3	pcs		

TAMBOUR STACK-ON STORAGE

	800	432	750	A1P04		34.0	0.080	3		stack-on storage storage
	1000	432	750	A1P05		41.0	0.104	3		stack-on storage storage
	1200	432	750	A1P06		52.0	0.124	3		stack-on storage storage

ADDITIONAL CHARGE

FEATURE	PRODUCT												COMMENTS
	A1P04	A1P05	A1P06							kg	m3	pcs	
II PRICE GROUP										0.0	0.0000	0	
SELF CLOSING SYSTEM										1.0	0.0010	1	

DESCRIPTION

 - NET WEIGHT

 VOLUME

 NUMBER OF PACKAGES

TECHNICAL SPECIFICATION

COLOURS

TOP, BOTTOM



BODY - FIRST GROUP

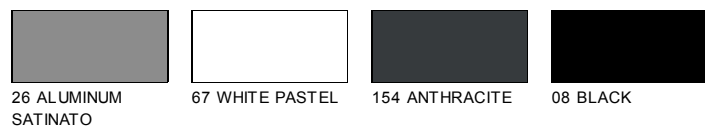

BODY - SECOND GROUP





FRONT - TAMBOUR



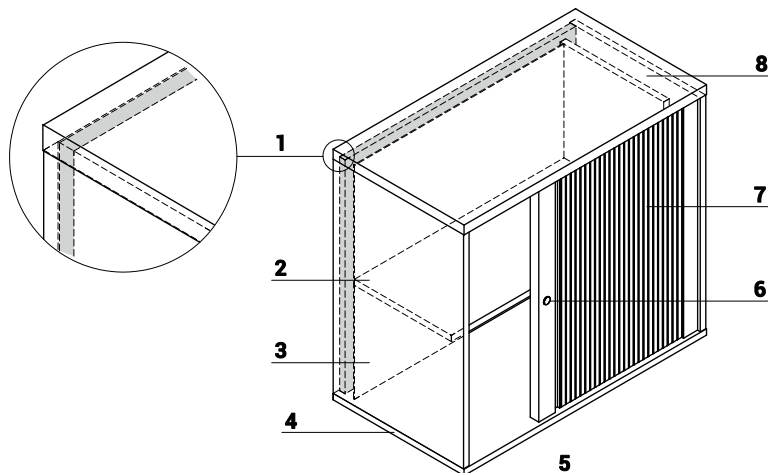







TAMBOUR STORAGES





- 1. Back MFC - 18mm, PVC edges
- 2. Shelf - MFC 18mm, PVC edge
- 3. Side panels - MFC 18mm, PVC edge
- 4. Base - MFC 18mm, PVC edge
- 5. Leveling feet 27mm - range 12mm
- 6. Patent lock
- 7. Front - tambour
- 8. Top - MFC 28mm, PVC edge

PRODUCT ILLUSTRATION	DIMENSIONS [mm]			INDEX SYMBOL						COMMENTS
	WIDTH	DEPTH	HEIGHT			kg	m3	pcs		

TAMBOUR STORAGES

	800	432	740	A2L04		32.6	0.303	1		
	1000	432	740	A2L05		43.0	0.392	1		
	1200	432	740	A2L06		46.5	0.464	1		
	1600	432	740	A2L08		56.0	0.615	1		
	1610	432	740	A2L16		56.0	0.619	1		
	800	432	1129	A3L04		56.0	0.453	1		
	1000	432	1129	A3L05		58.0	0.563	1		
	1200	432	1129	A3L06		64.4	0.673	1		
	1600	432	1129	A3L08		77.0	0.894	1		

ADDITIONAL CHARGE



FEATURE	PRODUCT													COMMENTS
	A2L04	A2L05	A2L06	A2L08	A2L16	A3L04	A3L05	A3L06	A3L08		kg	m3	pcs	
II PRICE GROUP											0.0	0.0000	0	

DESCRIPTION





 - NET WEIGHT

 VOLUME



 NUMBER OF PACKAGES

PRODUCT ILLUSTRATION	DIMENSIONS [mm]			INDEX SYMBOL						COMMENTS
	WIDTH	DEPTH	HEIGHT			kg	m3	pcs		

TAMBOUR STORAGES

	1610	432	1129	<b>A3L16</b>		77.0	0.900	1		
	800	432	1481	<b>A4L04</b>		42.0	0.591	1		
	1000	432	1481	<b>A4L05</b>		70.0	0.713	2		
	1200	432	1481	<b>A4L06</b>		78.0	0.853	2		

ADDITIONAL CHARGE

FEATURE	PRODUCT												COMMENTS
	A3L16	A4L04	A4L05	A4L06						kg	m3	pcs	
II PRICE GROUP										0.0	0.0000	0	

DESCRIPTION

 - NET WEIGHT

 VOLUME

 NUMBER OF PACKAGES



TECHNICAL SPECIFICATION

COLOURS

TOP, BOTTOM



14 BEECH



26 ALUMINUM SATINATO



31 CANADIAN OAK



34 CHESTNUT



39 POLAR BIRCH



64 COCOA

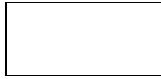

67 WHITE PASTEL



106 LOWLAND NUT



154 ANTHRACITE



BODY - FIRST GROUP



26 ALUMINUM SATINATO



67 WHITE PASTEL



154 ANTHRACITE



BODY - SECOND GROUP



14 BEECH



31 CANADIAN OAK



34 CHESTNUT



39 POLAR BIRCH



64 COCOA



106 LOWLAND NUT



FRONT



14 BEECH



26 ALUMINUM SATINATO



31 CANADIAN OAK



34 CHESTNUT



39 POLAR BIRCH



64 COCOA

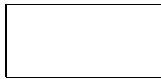

67 WHITE PASTEL



106 LOWLAND NUT



154 ANTHRACITE



TECHNICAL SPECIFICATION

IKDT PEDESTALS

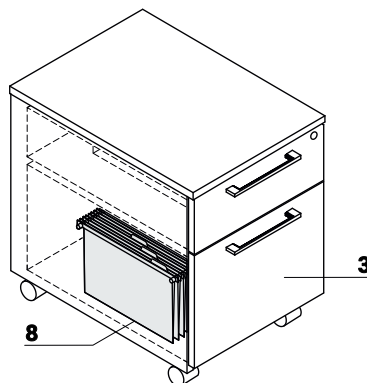
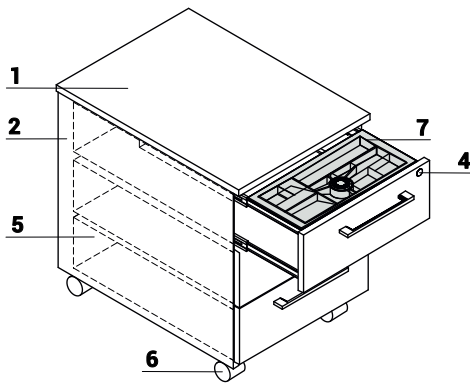

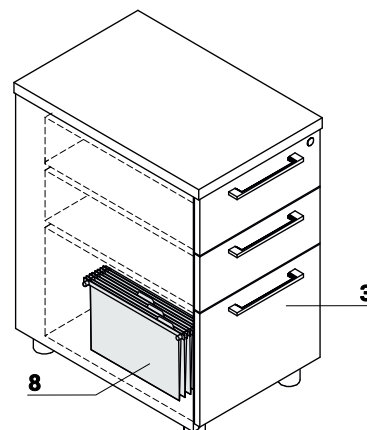
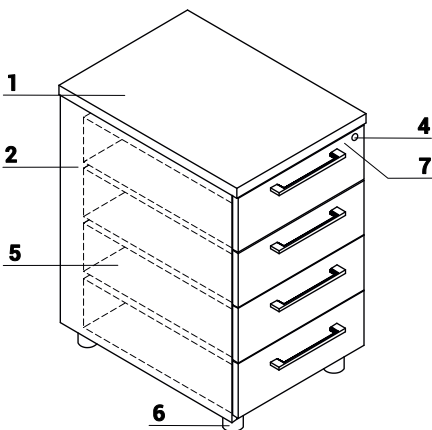

1. **Top** - MFC 18mm, PVC edge
2. **Body** - MFC 18mm, PVC edge
3. **Front** - MFC 18mm, PVC edge
4. **Central lock** - foldable key
5. **Metal drawer** - roll runners, max load 25kg, 80% extraction; Anti - tilt mechanism; OPTIONAL: ball runners, soft closing
6. **Castors** - Ø50mm, two with brakes
7. **Pencil tray** - black plastic
8. **Suspension files drawer** - ball runners, max load 30kg, 100% extraction  
A4 folders must be inserted parallelly to the front











1. **Top** - MFC 28mm, PVC edge
2. **Body** - MFC 18mm, PVC edge
3. **Front** - MFC 18mm, PVC edge
4. **Central lock** - foldable key
5. **Metal drawer** - roll runners, max load 25kg, 80% extraction; Anti - tilt mechanism; OPTIONAL: ball runners, soft closing
6. **Leveling** - 5mm range
7. **Pencil tray** - black plastic
8. **Suspension files drawer** - ball runners, max load 30kg, 100% extraction  
A4 folders must be inserted parallelly to the front





PRODUCT ILLUSTRATION	DIMENSIONS [mm]			INDEX SYMBOL						COMMENTS
	WIDTH	DEPTH	HEIGHT			kg	m3	pcs		

**IKDT PEDESTALS**

	402	600	586	<b>IKDT12</b>		30.0	0.151	1		mobile with suspension files drawer, drawers depth - 500mm
	402	600	586	<b>IKDT13</b>		23.0	0.151	1		mobile; drawers depth - 500mm
	402	800	586	<b>IKDT120</b>		26.0	0.198	1		mobile; drawers depth: standard - 500mm, file - 700mm
	402	800	586	<b>IKDT130</b>		27.0	0.198	1		mobile; drawers depth - 500mm
	402	600	740	<b>IKDT63</b>		27.0	0.211	1		file drawer; drawers depth - 500mm
	402	600	740	<b>IKDT64</b>		28.0	0.193	1		drawers depth - 500mm
	402	800	740	<b>IKDT73</b>		32.0	0.255	1		file drawer; drawers depth: standard - 500mm, file - 700mm
	402	800	740	<b>IKDT74</b>		33.0	0.255	1		drawers depth - 500mm

**ADDITIONAL CHARGE**

FEATURE	PRODUCT												COMMENTS	
	IKDT12	IKDT13	IKDT120	IKDT130	IKDT63	IKDT64	IKDT73	IKDT74			kg	m3		pcs
II PRICE GROUP											0.0	0.0000	0	
SELF CLOSING SYSTEM											1.0	0.0010	1	
BALL RUNNERS											1.0	0.0010	1	

DESCRIPTION

 - NET WEIGHT

 VOLUME

 NUMBER OF PACKAGES



TECHNICAL SPECIFICATION

COLOURS

TOP, BOTTOM



14 BEECH



26 ALUMINUM SATINATO



31 CANADIAN OAK



34 CHESTNUT



39 POLAR BIRCH



64 COCOA

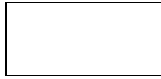

67 WHITE PASTEL



106 LOWLAND NUT



154 ANTHRACITE



BODY - FIRST GROUP



26 ALUMINUM SATINATO



67 WHITE PASTEL



154 ANTHRACITE



BODY - SECOND GROUP



14 BEECH



31 CANADIAN OAK



34 CHESTNUT



39 POLAR BIRCH



64 COCOA



106 LOWLAND NUT



FRONT



14 BEECH



26 ALUMINUM SATINATO



31 CANADIAN OAK



34 CHESTNUT



39 POLAR BIRCH



64 COCOA



67 WHITE PASTEL

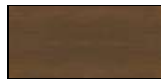

106 LOWLAND NUT



154 ANTHRACITE



TECHNICAL SPECIFICATION

IKRT PEDESTALS

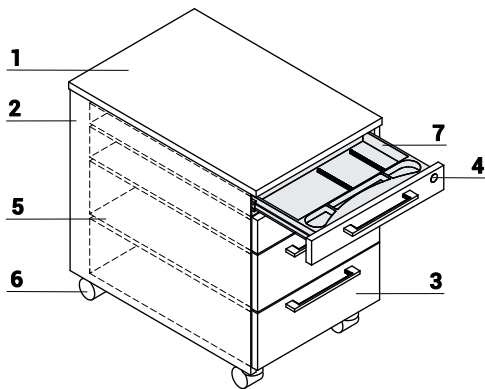

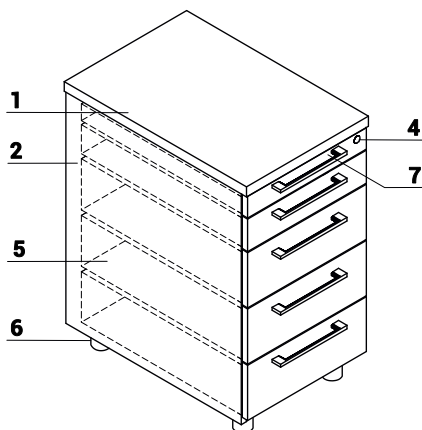

1. **Top** - MFC 18mm, PVC edge
2. **Body** - MFC 18mm, PVC edge
3. **Front** - MFC 18mm, PVC edge
4. **Central lock** - foldable key
5. **Metal drawer** - roll runners, max load 25kg, 80% extraction; Anti - tilt mechanism; OPTIONAL: ball runners, soft closing
6. **Castors** - Ø50mm, two with brakes
7. **Separate pencil drawer**
8. **Suspension files drawer** - ball runners, max load 30kg, 100% extraction  
A4 folders must be inserted parallelly to the front



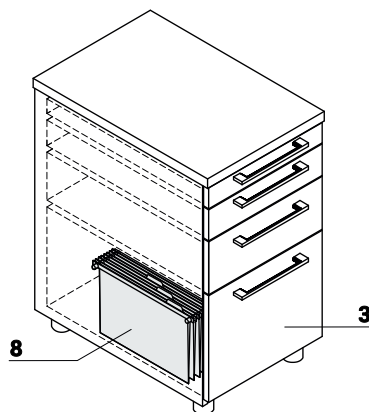







1. **Top** - MFC 28mm, PVC edge
2. **Body** - MFC 18mm, PVC edge
3. **Front** - MFC 18mm, PVC edge
4. **Central lock** - foldable key
5. **Metal drawer** - roll runners, max load 25kg, 80% extraction; Anti - tilt mechanism; OPTIONAL: ball runners, soft closing
6. **Leveling** - 5mm range
7. **Separate pencil drawer**
8. **Suspension files drawer** - ball runners, max load 30kg, 100% extraction  
A4 folders must be inserted parallelly to the front





PRODUCT ILLUSTRATION	DIMENSIONS [mm]			INDEX SYMBOL						COMMENTS
	WIDTH	DEPTH	HEIGHT			kg	m3	pcs		

IKRT PEDESTALS

	402	600	586	IKRT12		31.0	0.151	1		mobile with suspension files drawer, drawers depth - 500mm
	402	600	586	IKRT13		24.0	0.151	1		mobile; drawers depth - 500mm
	402	800	586	IKRT120		27.0	0.198	1		mobile with suspension files drawer; drawers depth: standard - 500mm, file - 700mm
	402	800	586	IKRT130		28.0	0.198	1		mobile; drawers depth - 500mm
	402	600	740	IKRT63		28.0	0.211	1		file drawer; drawers depth - 500mm
	402	600	740	IKRT64		29.0	0.211	1		drawers depth - 500mm
	402	800	740	IKRT73		33.0	0.255	1		file drawer; drawers depth: standard - 500mm, file - 700mm
	402	800	740	IKRT74		34.0	0.255	1		drawers depth - 500mm

ADDITIONAL CHARGE

FEATURE	PRODUCT												COMMENTS	
	IKRT12	IKRT13	IKRT120	IKRT130	IKRT63	IKRT64	IKRT73	IKRT74			kg	m3		pcs
II PRICE GROUP											0.0	0.0000	0	
SELF CLOSING SYSTEM											1.0	0.0010	1	
BALL RUNNERS											1.0	0.0010	1	

DESCRIPTION

 - NET WEIGHT

 VOLUME

 NUMBER OF PACKAGES



TECHNICAL SPECIFICATION

COLOURS

TOP, BOTTOM

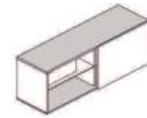

BODY - FIRST GROUP

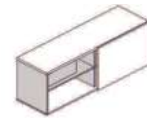
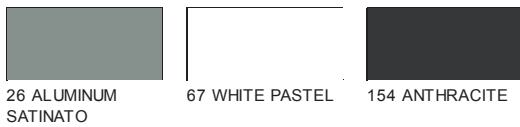

BODY - SECOND GROUP

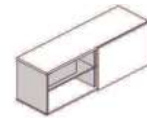
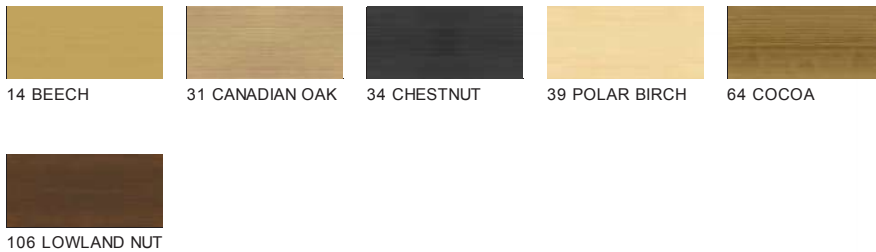

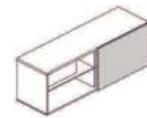

FRONT

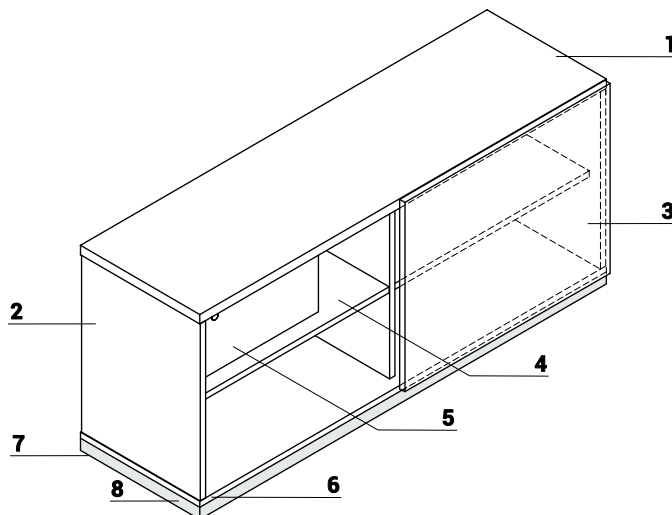

MANAGERIAL STORAGE





1. **Top** - MFC 28mm, PVC edge
2. **Side panels** - MFC 18mm, PVC edge
3. **Front** - MFC 18mm, PVC edge
4. **Shelf** - MFC 18mm, PVC edge
5. **Drawer** - MFC 18mm, PVC edge, lock - possible to change location
6. **Base** - MFC 18mm, PVC edge
7. **Leveling feet** - range 5mm
8. **Option with additional charge** - metal base - colour: M009 - aluminum semi-matte

PRODUCT ILLUSTRATION	DIMENSIONS [mm]			INDEX SYMBOL						COMMENTS
	WIDTH	DEPTH	HEIGHT			kg	m3	pcs		

**MANAGERIAL STORAGES**

	1400	432	600	<b>IA14M</b>		60.5	0.173	5		
---	------	-----	-----	--------------	--	------	-------	---	--	--

**ADDITIONAL CHARGE**

FEATURE	PRODUCT												COMMENTS
	IA14M									kg	m3	pcs	
II PRICE GROUP										0.0	0.0000	0	
METAL KICK PLATE										0.0	0.0000	0	

DESCRIPTION

 - NET WEIGHT

 VOLUME

 NUMBER OF PACKAGES



TECHNICAL SPECIFICATION

COLOURS

TOP, BOTTOM



BODY - FIRST GROUP

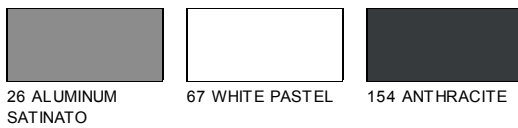

BODY - SECOND GROUP





FRONT



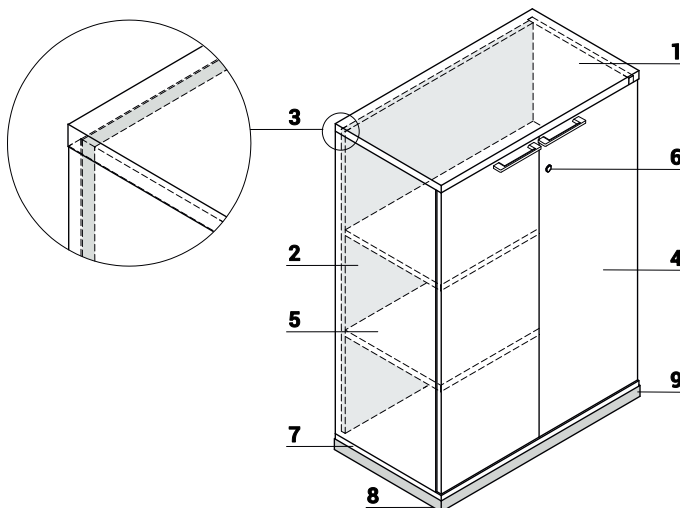

STORAGES



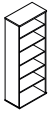

1. **Top** - MFC 28mm, PVC edge
2. **Side panels** - MFC 18mm, PVC edge
3. **Back MFC** - 18mm, PVC edges
4. **Front** - MFC 18 mm, PVC edges, plain hinge 110°
5. **Shelf** - MFC 18mm, PVC edge
6. **Espagnolet lock**
7. **Base** - MFC 18mm, PVC edge
8. **Leveling feet 27mm** - range 12mm
9. **Option with additional charge** - metal base - colour: M009 - aluminum semi-matte

PRODUCT ILLUSTRATION	DIMENSIONS [mm]			INDEX SYMBOL					COMMENTS
	WIDTH	DEPTH	HEIGHT			kg	m3	pcs	

60H STORAGE 800 mm WIDE

	801	432	2185	IA6504		69.0	0.182	3	
	801	432	2185	IA6104		90.0	0.238	4	

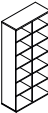

60H STORAGE 1000 mm WIDE

	1000	432	2185	IA6505		89.0	0.203	3	
	1000	432	2185	IA6105		115.0	0.273	4	

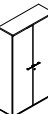
60H STORAGE 1200 mm WIDE

	1200	432	2185	IA6506		101.0	0.241	3	
	1200	432	2185	IA6106		131.0	0.325	4	

ADDITIONAL CHARGE



FEATURE	PRODUCT										COMMENTS
	IA6504	IA6104	IA6505	IA6105	IA6506	IA6106		kg	m3	pcs	
II PRICE GROUP								0.0	0.0000	0	
ANGLE HINGE 170°								1.0	0.0010	1	
METAL KICK PLATE								0.0	0.0000	0	

DESCRIPTION



 - NET WEIGHT

 VOLUME





 NUMBER OF PACKAGES

PRODUCT ILLUSTRATION	DIMENSIONS [mm]			INDEX SYMBOL						COMMENTS
	WIDTH	DEPTH	HEIGHT			kg	m3	pcs		



50H STORAGE 400 mm WIDE

	402	432	1833	IA5902		39.0	0.091	3		
	402	432	1833	IA58P2		41.0	0.103	3		
	402	432	1833	IA56P2		46.0	0.103	3		right door

50H STORAGE 800 mm WIDE

	801	432	1833	IA5504		59.0	0.182	3		
	801	432	1833	IA5404		67.0	0.202	4		
	801	432	1833	IA5304		71.0	0.212	4		
	801	432	1833	IA5104		76.0	0.230	4		
	802	802	1833	IA5NP4		0.0	0.001	0		Corner storage

ADDITIONAL CHARGE



FEATURE	PRODUCT											COMMENTS
	IA5902	IA58P2	IA56P2	IA5504	IA5404	IA5304	IA5104	IA5NP4	kg	m3	pcs	
II PRICE GROUP									0.0	0.0000	0	
ANGLE HINGE 170°									1.0	0.0010	1	
METAL KICK PLATE									0.0	0.0000	0	

DESCRIPTION

 - NET WEIGHT

 VOLUME



 NUMBER OF PACKAGES

PRODUCT ILLUSTRATION	DIMENSIONS [mm]			INDEX SYMBOL						COMMENTS
	WIDTH	DEPTH	HEIGHT			kg	m3	pcs		

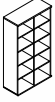
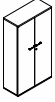

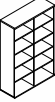

50H STORAGES 1000 mm WIDE

	1000	432	1833	IA5505		77.0	0.178	3		
	1000	432	1833	IA5105		98.0	0.237	4		



50H STORAGES 1200 mm WIDE

	1200	432	1833	IA5506		86.0	0.207	3		
	1200	432	1833	IA5106		111.0	0.278	4		

40H STORAGES 800 mm WIDE

	801	432	1481	IA4504		49.0	0.129	3		
	801	432	1481	IA4404		56.0	0.149	4		
	801	432	1481	IA4304		60.0	0.159	4		
	801	432	1481	IA4104		62.0	0.187	4		

ADDITIONAL CHARGE



FEATURE	PRODUCT											COMMENTS
	IA5505	IA5105	IA5506	IA5106	IA4504	IA4404	IA4304	IA4104	kg	m3	pcs	
II PRICE GROUP									0.0	0.0000	0	
ANGLE HINGE 170°									1.0	0.0010	1	
METAL KICK PLATE									0.0	0.0000	0	

DESCRIPTION

 - NET WEIGHT

 VOLUME



 NUMBER OF PACKAGES

PRODUCT ILLUSTRATION	DIMENSIONS [mm]			INDEX SYMBOL						COMMENTS
	WIDTH	DEPTH	HEIGHT			kg	m3	pcs		



40H STORAGE 1200 mm WIDE

	1200	432	1481	<b>IA4506</b>		62.0	0.189	3		
---	------	-----	------	---------------	--	------	-------	---	--	--



30H STORAGES 400 mm WIDE

	402	432	1129	<b>IA3902</b>		25.0	0.066	3		
	402	432	1129	<b>IA38P2</b>		29.0	0.071	3		right door
	402	432	1129	<b>IA36P2</b>		30.0	0.072	3		right door

30H STORAGES 800 mm WIDE

	801	432	1129	<b>IA3504</b>		39.0	0.106	3		
	801	432	1129	<b>IA3404</b>		42.0	0.124	4		
	801	432	1129	<b>IA3104</b>		50.0	0.136	4		

ADDITIONAL CHARGE



FEATURE	PRODUCT											COMMENTS
	IA4506	IA3902	IA38P2	IA36P2	IA3504	IA3404	IA3104		kg	m3	pcs	
II PRICE GROUP									0.0	0.0000	0	
ANGLE HINGE 170°									1.0	0.0010	1	
METAL KICK PLATE									0.0	0.0000	0	

DESCRIPTION



 - NET WEIGHT

 VOLUME



 NUMBER OF PACKAGES

PRODUCT ILLUSTRATION	DIMENSIONS [mm]			INDEX SYMBOL						COMMENTS
	WIDTH	DEPTH	HEIGHT			kg	m3	pcs		

3OH STORAGES 1000 mm WIDE

	1000	432	1129	IA3505		51.0	0.118	3		
	1000	432	1129	IA3105		64.0	0.156	4		



3OH STORAGES 1200 mm WIDE

	1200	432	1129	IA3506		57.0	0.141	3		
	1200	432	1129	IA3106		72.0	0.186	4		

3OH STORAGE 1600 mm WIDE

	1600	432	1129	IA3508		73.0	0.176	3		
--	------	-----	------	--------	--	------	-------	---	--	--

ADDITIONAL CHARGE



FEATURE	PRODUCT													COMMENTS
	IA3505	IA3105	IA3506	IA3106	IA3508						kg	m3	pcs	
II PRICE GROUP											0.0	0.0000	0	
ANGLE HINGE 170°											1.0	0.0010	1	
METAL KICK PLATE											0.0	0.0000	0	

DESCRIPTION









 - NET WEIGHT

 VOLUME



 NUMBER OF PACKAGES

PRODUCT ILLUSTRATION	DIMENSIONS [mm]			INDEX SYMBOL						COMMENTS
	WIDTH	DEPTH	HEIGHT			kg	m3	pcs		

20H STORAGE

	402	432	777	IA2902		19.0	0.048	3		
	402	432	777	IA26P2		22.0	0.056	3		right door
	801	432	740	IA25B4		29.0	0.086	3		
	801	432	740	IA21B4		35.5	0.105	4		
	801	432	777	IA2504		30.0	0.086	3		
	801	432	777	IA2104		37.0	0.105	4		
	1200	432	777	IA2506		46.0	0.126	3		
	1600	432	777	IA2508		55.0	0.147	3		

ADDITIONAL CHARGE



FEATURE	PRODUCT												COMMENTS
	IA2902	IA26P2	IA25B4	IA21B4	IA2504	IA2104	IA2506	IA2508			kg	m3	
II PRICE GROUP										0.0	0.0000	0	
ANGLE HINGE 170°										1.0	0.0010	1	
METAL KICK PLATE										0.0	0.0000	0	

DESCRIPTION





 - NET WEIGHT

 VOLUME



 NUMBER OF PACKAGES

PRODUCT ILLUSTRATION	DIMENSIONS [mm]			INDEX SYMBOL						COMMENTS
	WIDTH	DEPTH	HEIGHT			kg	m3	pcs		

2 OH STACK-ON STORAGES

	402	432	750	IA1902		18.0	0.041	2		
	402	432	750	IA16P2		21.0	0.048	2		right door
	801	432	750	IA1504		23.0	0.052	2		
	801	432	750	IA1104		30.0	0.072	3		
	802	802	750	IA1NP4		0.0	0.001	0		Corner storage

ADDITIONAL CHARGE

FEATURE	PRODUCT													COMMENTS
	IA1902	IA16P2	IA1504	IA1104	IA1NP4						kg	m3	pcs	
II PRICE GROUP											0.0	0.0000	0	
ANGLE HINGE 170°											1.0	0.0010	1	

DESCRIPTION

 - NET WEIGHT

 VOLUME

 NUMBER OF PACKAGES



TECHNICAL SPECIFICATION

COLOURS

TOP, BOTTOM



BODY - FIRST GROUP

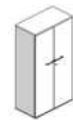
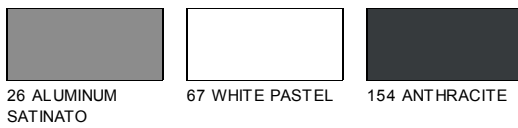

BODY - SECOND GROUP



FRONT



WARDROBES

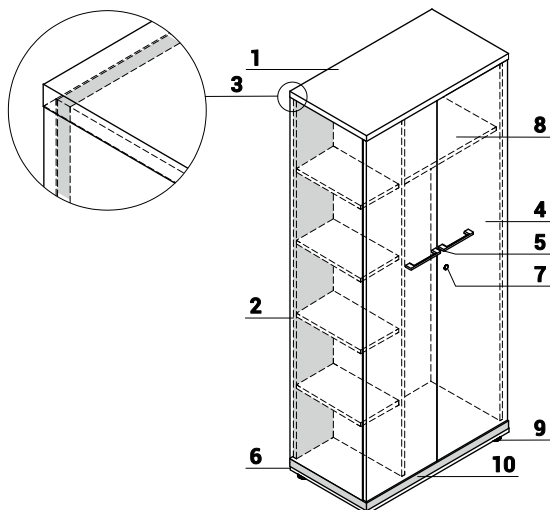

- 1. **Top** - MFC 28mm, PVC edge
- 2. **Side panels** - MFC 18mm, PVC edge
- 3. **Back MFC** - 18mm, PVC edges
- 4. **Front** - MFC 18 mm, PVC edges, plain hinge 110°
- 5. **Aluminum handle**
- 6. **Base** - MFC 18mm, PVC edge
- 7. **Espagnolet lock**
- 8. **Shelf** - MFC 18mm, PVC edge
- 9. **Leveling feet 27mm** - range 12mm
- 10. **Option with additional charge** - metal base - colour: M009 - aluminum semi-matte

TECHNICAL SPECIFICATION

WARDROBES

IA57P3\*\*

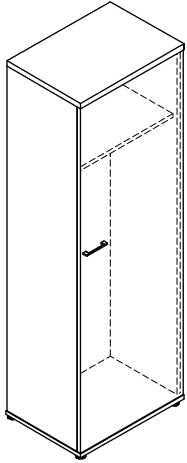

IA52P4\*

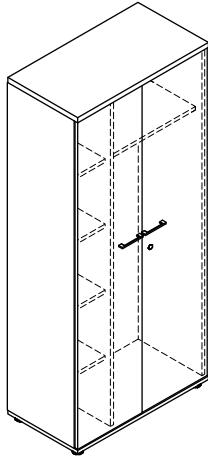

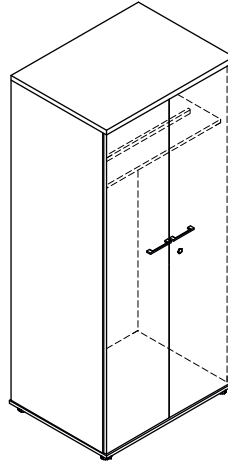

IA6204\*



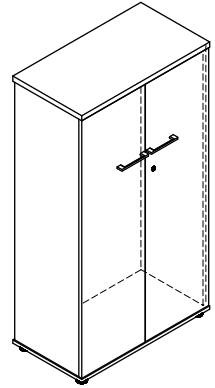



IA4204\*\*



\* Coat rod \*\* Slide-out hanger

PRODUCT ILLUSTRATION	DIMENSIONS [mm]			INDEX SYMBOL						COMMENTS
	WIDTH	DEPTH	HEIGHT			kg	m3	pcs		



WARDROBES

	602	432	1833	IA57P3		54.0	0.146	3		wardrobe with slide out hanger, right door, espagnolette lock
	801	600	1833	IA6204		72.0	0.191	3		wardrobe with coat rod, espagnolette lock
	801	432	1833	IA52P4		76.0	0.215	3		wardrobe/storage cabinet with slide out hanger, espagnolette lock
	802	432	1481	IA4204		52.0	0.137	4		wardrobe with slide out hanger, 4 OH; espagnolette lock

2 OH STACK-ON STORAGES

	602	432	750	IA16P3		27.0	0.067	2		
--	-----	-----	-----	--------	--	------	-------	---	--	--

ADDITIONAL CHARGE

FEATURE	PRODUCT											COMMENTS
	IA57P3	IA6204	IA52P4	IA4204	IA16P3				kg	m3	pcs	
II PRICE GROUP									0.0	0.0000	0	
ANGLE HINGE 170°									1.0	0.0010	1	
METAL KICK PLATE									0.0	0.0000	0	

DESCRIPTION

 - NET WEIGHT

 VOLUME

 NUMBER OF PACKAGES



TECHNICAL SPECIFICATION

COLOURS

TOP, BOTTOM



BODY - FIRST GROUP

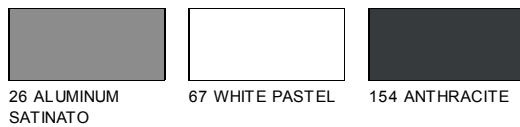

BODY - SECOND GROUP



FRONT - STORAGES AND FILING CABINETS WITH METAL SHELVES



FRONT - FILING DRAWERS CABINETS

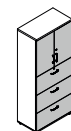



TECHNICAL SPECIFICATION

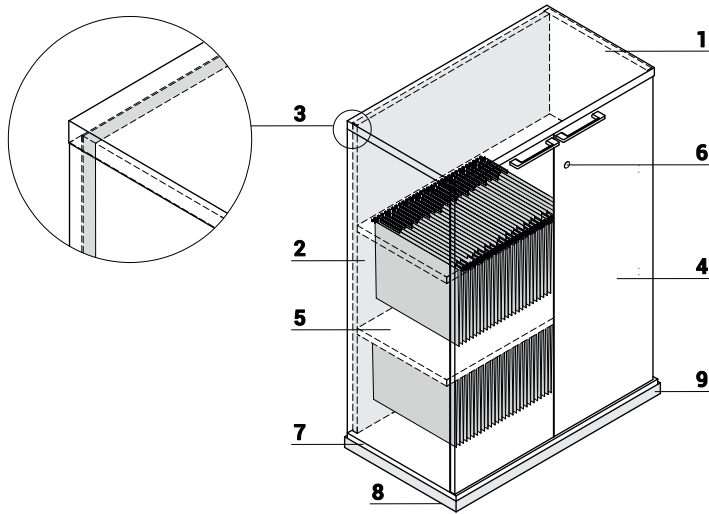







STORAGES AND FILING CABINETS WITH METAL SHELVES





1. **Top** - MFC 28mm, PVC edge
2. **Side panels** - MFC 18mm, PVC edge
3. **Back MFC** - 18mm, PVC edges
4. **Front** - MFC 18 mm, PVC edges, plain hinge 110°
5. **Metal shelf with possibility of using suspension files** - max load 41kg, colour: M009 - aluminum semi-matte
6. **Espagnolet lock**
7. **Base** - MFC 18mm, PVC edge
8. **Leveling feet 27mm** - range 12mm
9. **Option with additional charge** - metal base - colour: M009 - aluminum semi-matte

PRODUCT ILLUSTRATION	DIMENSIONS [mm]			INDEX SYMBOL						COMMENTS
	WIDTH	DEPTH	HEIGHT			kg	m3	pcs		

**STORAGES AND FILING CABINETS WITH METAL SHELVES**

	801	432	1129	IA3504TM		38.0	0.106	3		number of shelves - 2pcs
	801	432	1129	IA3104TM		49.0	0.136	4		number of shelves - 2pcs
	1000	432	1129	IA3505TM		42.0	0.118	3		number of shelves - 2pcs
	1000	432	1129	IA3105TM		55.0	0.156	4		number of shelves - 2pcs
	1200	432	1129	IA3506TM		49.0	0.149	3		number of shelves - 2pcs
	1200	432	1129	IA3106TM		64.0	0.194	4		number of shelves - 2pcs
	801	432	1833	IA5504TM		57.0	0.182	3		number of shelves - 4pcs
	801	432	1833	IA5104TM		74.0	0.230	4		number of shelves - 4pcs
	1000	432	1833	IA5505TM		62.0	0.177	3		number of shelves - 4pcs

**ADDITIONAL CHARGE**



FEATURE	PRODUCT													COMMENTS
	IA3504TM	IA3104TM	IA3505TM	IA3105TM	IA3506TM	IA3106TM	IA5504TM	IA5104TM	IA5505TM		kg	m3	pcs	
II PRICE GROUP											0.0	0.0000	0	
ANGLE HINGE 170°											1.0	0.0010	1	
METAL KICK PLATE											0.0	0.0000	0	

DESCRIPTION



 - NET WEIGHT

 VOLUME



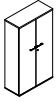
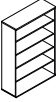

 NUMBER OF PACKAGES

PRODUCT ILLUSTRATION	DIMENSIONS [mm]			INDEX SYMBOL						COMMENTS
	WIDTH	DEPTH	HEIGHT			kg	m3	pcs		

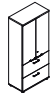
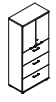

**STORAGES AND FILING CABINETS WITH METAL SHELVES**

	1000	432	1833	<b>IA5105TM</b>		83.0	0.236	4		number of shelves - 4pcs
	1200	432	1833	<b>IA5506TM</b>		69.0	0.240	3		number of shelves - 4pcs
	1200	432	1833	<b>IA5106TM</b>		94.0	0.311	4		number of shelves - 4pcs

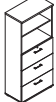
**FILING DRAWERS CABINETS**

	801	432	1129	<b>IA3F04</b>		54.7	0.435	2		suspension file drawers without - open bottom
	1000	432	1129	<b>IA6F04</b>		90.0	0.546	2		suspension file drawers with bottom
	801	432	1833	<b>IA54B4</b>		76.1	0.699	2		suspension file drawers without - open bottom, MFC shelf
	801	432	1833	<b>IA54C4</b>		72.5	0.699	2		suspension file drawers without - open bottom, MFC shelf
	801	432	1833	<b>IA54D4</b>		74.1	0.684	1		suspension file drawers without - open bottom, MFC shelf
	801	432	1833	<b>IA54E4</b>		70.5	0.684	1		suspension file drawers without - open bottom, MFC shelf

**ADDITIONAL CHARGE**

FEATURE	PRODUCT													COMMENTS
	IA5105TM	IA5506TM	IA5106TM	IA3F04	IA6F04	IA54B4	IA54C4	IA54D4	IA54E4		kg	m3	pcs	
II PRICE GROUP											0.0	0.0000	0	
ANGLE HINGE 170°											1.0	0.0010	1	
METAL KICK PLATE											0.0	0.0000	0	

DESCRIPTION

 - NET WEIGHT

 VOLUME

 NUMBER OF PACKAGES



TECHNICAL SPECIFICATION

COLOURS

TOP, BOTTOM

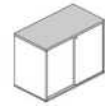

BODY - FIRST GROUP

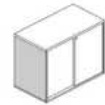
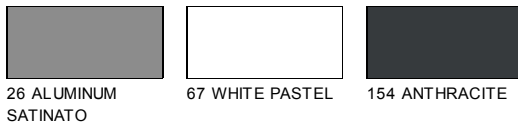

BODY - SECOND GROUP

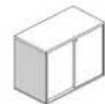

FRONT

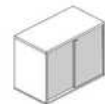

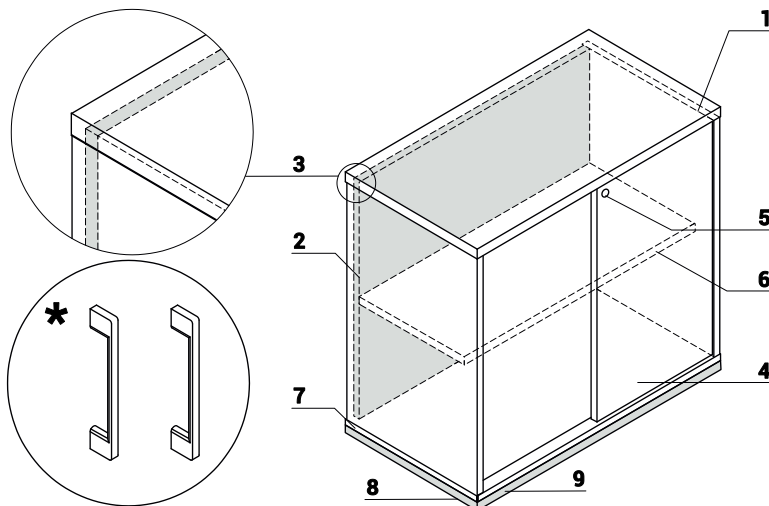

SLIDING DOOR STORAGES











- 1. Top - MFC 28mm, PVC edge
- 2. Side panels - MFC 18mm, PVC edge
- 3. Back MFC - 18mm, PVC edges
- 4. Sliding front - MFC 18mm, PVC edge
- 5. Patent lock
- 6. Shelf - MFC 18mm, PVC edge
- 7. Base - MFC 18mm, PVC edge
- 8. Leveling feet 27mm - range 12mm
- 9. Option with additional charge - metal base - colour: M009 - aluminum semi-matte



\* - Handle - aluminum, ordered separately

PRODUCT ILLUSTRATION	DIMENSIONS [mm]			INDEX SYMBOL						COMMENTS
	WIDTH	DEPTH	HEIGHT			kg	m3	pcs		

SLIDING DOOR STORAGES

	800	432	740	IA2P04		37.0	0.107	4		no handles
	1000	432	740	IA2P05		43.5	0.127	4		no handles
	1200	432	740	IA2P06		44.0	0.142	4		no handles
	1600	432	740	IA2P08		68.0	0.181	4		no handles
	1610	432	740	IA2P16		68.0	0.183	4		no handles
	800	432	1129	IA3P04		50.0	0.141	4		no handles
	1000	432	1129	IA3P05		64.0	0.165	4		no handles
	1200	432	1129	IA3P06		78.0	0.196	4		no handles
	1600	432	1129	IA3P08		93.0	0.259	4		no handles

ADDITIONAL CHARGE



FEATURE	PRODUCT													COMMENTS
	IA2P04	IA2P05	IA2P06	IA2P08	IA2P16	IA3P04	IA3P05	IA3P06	IA3P08		kg	m3	pcs	
II PRICE GROUP											0.0	0.0000	0	
SELF CLOSING SYSTEM											1.0	0.0010	1	
METAL KICK PLATE											0.0	0.0000	0	

DESCRIPTION







 - NET WEIGHT

 VOLUME

 NUMBER OF PACKAGES

PRODUCT ILLUSTRATION	DIMENSIONS [mm]			INDEX SYMBOL						COMMENTS
	WIDTH	DEPTH	HEIGHT			kg	m3	pcs		

SLIDING DOOR STORAGES

	1610	432	1129	IA3P16		93.0	0.264	4		no handles
	800	432	1481	IA4P04		62.0	0.173	4		no handles
	1000	432	1481	IA4P05		80.0	0.201	4		no handles
	1200	432	1481	IA4P06		92.0	0.239	4		no handles
	800	432	1833	IA5P04		75.0	0.219	4		no handles
	1000	432	1833	IA5P05		95.0	0.237	4		no handles
	1200	432	1833	IA5P06		106.0	0.282	4		no handles



TAMBOUR STACK-ON STORAGE

	1200	432	750	IA1P06		52.0	0.124	3		Stack - on storage, no handles
---	------	-----	-----	--------	--	------	-------	---	--	--------------------------------

HANDLES

	160	110	20	HPR2		0.2	0.000	1		handles PRO (2 pcs)
---	-----	-----	----	------	--	-----	-------	---	--	---------------------

ADDITIONAL CHARGE

FEATURE	PRODUCT											COMMENTS
	IA3P16	IA4P04	IA4P05	IA4P06	IA5P04	IA5P05	IA5P06	IA1P06	kg	m3	pcs	
II PRICE GROUP									0.0	0.0000	0	
SELF CLOSING SYSTEM									1.0	0.0010	1	
METAL KICK PLATE									0.0	0.0000	0	

DESCRIPTION

 - NET WEIGHT

 VOLUME

 NUMBER OF PACKAGES



TECHNICAL SPECIFICATION

COLOURS

TOP, BOTTOM



BODY - FIRST GROUP

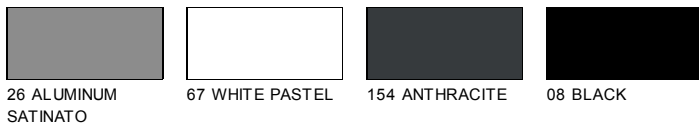

BODY - SECOND GROUP



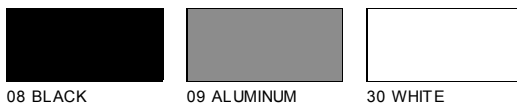

FRONT - TAMBOUR



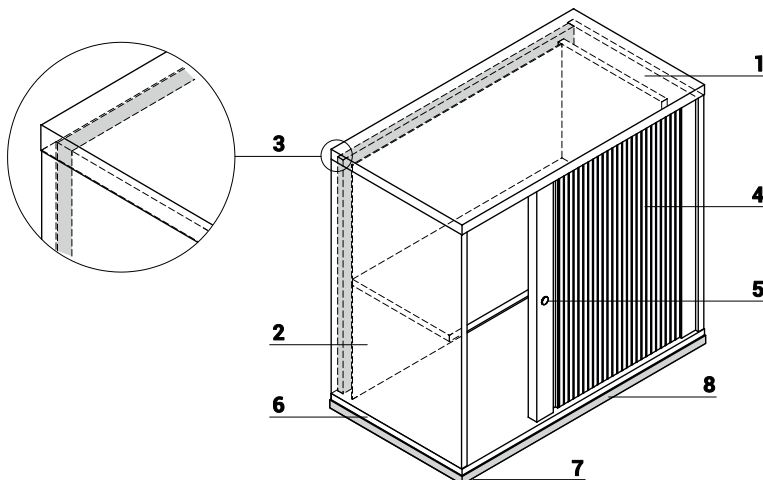







TAMBOUR STORAGES





1. **Top** - MFC 28mm, PVC edge
2. **Side panels** - MFC 18mm, PVC edge
3. **Back MFC** - 18mm, PVC edges
4. **Front** - tambour
5. **Patent lock**
6. **Base** - MFC 18mm, PVC edge
7. **Leveling feet** 27mm - range 12mm
8. **Option with additional charge** - metal base - colour: M009 - aluminum semi-matte

PRODUCT ILLUSTRATION	DIMENSIONS [mm]			INDEX SYMBOL						COMMENTS
	WIDTH	DEPTH	HEIGHT			kg	m3	pcs		

TAMBOUR STORAGES

	800	432	740	IA2L04		34.6	0.318	2		
	1000	432	740	IA2L05		46.0	0.410	2		
	1200	432	740	IA2L06		49.5	0.485	2		
	1600	432	740	IA2L08		60.0	0.645	2		
	1610	432	740	IA2L16		60.0	0.648	2		
	800	432	1129	IA3L04		58.0	0.467	2		
	1000	432	1129	IA3L05		61.0	0.581	2		
	1200	434	1129	IA3L06		67.4	0.695	2		
	1600	432	1129	IA3L08		81.0	0.923	2		

ADDITIONAL CHARGE



FEATURE	PRODUCT													COMMENTS
	IA2L04	IA2L05	IA2L06	IA2L08	IA2L16	IA3L04	IA3L05	IA3L06	IA3L08		kg	m3	pcs	
II PRICE GROUP											0.0	0.0000	0	
METAL KICK PLATE											0.0	0.0000	0	

DESCRIPTION





 - NET WEIGHT

 VOLUME



 NUMBER OF PACKAGES

PRODUCT ILLUSTRATION	DIMENSIONS [mm]			INDEX SYMBOL						COMMENTS
	WIDTH	DEPTH	HEIGHT			kg	m3	pcs		

TAMBOUR STORAGES

	1610	432	1129	<b>IA3L16</b>		81.0	0.929	2		
	800	432	1481	<b>IA4L04</b>		44.0	0.605	2		
	1000	432	1481	<b>IA4L05</b>		73.0	0.732	3		
	1200	432	1481	<b>IA4L06</b>		81.0	0.875	3		

ADDITIONAL CHARGE

FEATURE	PRODUCT												COMMENTS
	IA3L16	IA4L04	IA4L05	IA4L06						kg	m3	pcs	
II PRICE GROUP										0.0	0.0000	0	
METAL KICK PLATE										0.0	0.0000	0	

DESCRIPTION

 - NET WEIGHT

 VOLUME

 NUMBER OF PACKAGES





TECHNICAL SPECIFICATION

COLOURS

MOBILE PEDESTAL SLD

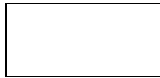

67 WHITE PASTEL

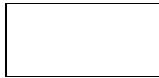

73 HIGH GLOSS  
WHITE

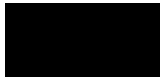
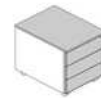
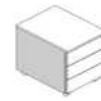

08 BLACK

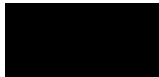

101 HIGH GLOSS  
BLACK

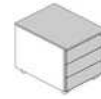
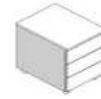

26 ALUMINUM  
SATINATO



148 HIGH GLOSS  
GRAY

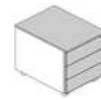
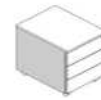

154 ANTHRACITE



155 ANTHRACITE  
HIGH GLOSS

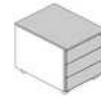

CUSHION SKP13 - FABRIC NEMO



NE-1 BEIGE



NE-2 YELLOW



NE-3 ORANGE



NE-5 RED



NE-9 GREEN

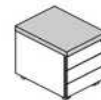
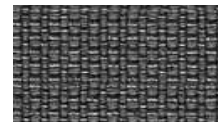

NE-10 GREY



NE-14 DARK GREY



NE-15 NAVY BLUE



NE-16 BLACK



NE-17 BLUE

CUSHION SKP13 - FABRIC RUNNER - SECOND GROUP



R-63034 ORANGE



R-64089 RED



R-66063 BLUE



R-60011 GREY



R-68056 GREEN

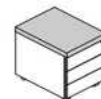
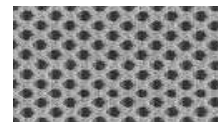

R-66064  
NAVY-BLUE



R-60999 BLACK

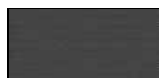

R-60025 DARK  
GREY



R-61128 BEIGE

CUSHION SKP13 - FABRIC MEDLEY - SECOND GROUP



M-68005 DARK  
OLIVE



M-68002 LIGHT  
OLIVE



M-68115 GREEN



M-61002 BEIGE



M-67053 NAVY  
BLUE

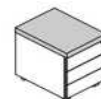

M-67006 LIGHT  
BLUE



M-66008 GREY



M-64019 RED



M-63064 PINK



M-60999 BLACK

TECHNICAL SPECIFICATION

COLOURS

CUSHION SKP13 - FABRIC ATLANTIC - SECOND GROUP

					
A-67043 DARK TURQUOISE	A-67030 SEA-GREEN	A-60141 LIGHT GREY	A-60011 GREY	A-66064 NAVY BLUE	
					
A-65037 VIOLET	A-62048 OLIVE	A-64089 RED	A-61078 BEIGE	A-60025 GRAPHITE	

CUSHION SKP13 - FABRIC SYNERGY - THIRD PRICE GROUP

					
LDS08 GREY MELANGE	LDS20 LIGHT GREY	LDS27 BLACK	LDS29 DARK GREY	LDS50 DARK GREEN	
					
LDS53 GREEN	LDS57 TURQUOISE	LDS60 BOTTLE GREEN	LDS61 PLUM	LDS69 NAVY BLUE	
					
LDS84 ORANGE	LDS86 RED	LDS88 AUBERGINE	LDS85 CORAL		

CUSHION SKP13 - FABRIC XTREME - THIRD PRICE GROUP

					
XR160 SEA-GREEN	XR430 DARK TURQUOISE	XR026 NAVY BLUE	XR084 VIOLET	XR009 BLACK	
					
XR420 OLIVE	XR081 DARK GREY	XR094 GREY	XR108 BEIGE	XR079 RED	
					
YS158 BROWN	YS083 BLUE-GREY	YS071 LIGHT BROWN	YS166 SAND BROWN		

TECHNICAL SPECIFICATION

COLOURS

TOP, BOTTOM, BODY



08 BLACK



26 ALUMINUM SATINATO



67 WHITE PASTEL



154 ANTHRACITE

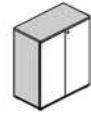

FRONT HPL

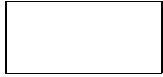

73 HIGH GLOSS WHITE



74 HIGH GLOSS ORANGE



80 HIGH GLOSS LIME



81 HIGH GLOSS BURGUNDY



101 HIGH GLOSS BLACK

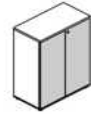

102 HIGH GLOSS YELLOW



108 BLUE HIGH GLOSS



127 HIGH GLOSS FUCHSIA



148 HIGH GLOSS GRAY



155 ANTHRACITE HIGH GLOSS

TOP - A800GT

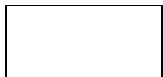

67 WHITE PASTEL



WHITE, LACOBEL



26 ALUMINUM SATINATO



GLASS LACOBEL, SILVER



08 BLACK



BLACK, LACOBEL



154 ANTHRACITE



BLACK, LACOBEL



TECHNICAL SPECIFICATION

MOBILE PEDESTAL WITHOUT HANDLES

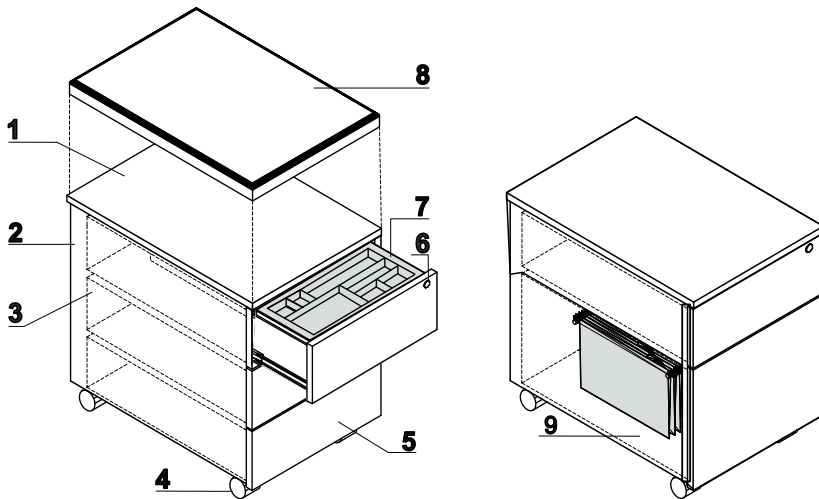

- 1. **Top** - MFC 18mm, covered with high gloss HPL
- 2. **Body** - MFC 18mm, PVC edge
- 3. **Metal drawer** - roll runners, max load 25kg, 80% extraction; Anti - tilt mechanism; OPTIONAL: ball runners, soft closing
- 4. **Castors** - Ø50mm, two with brakes
- 5. **Front** - HPL 18mm - high gloss, PVC edge
- 6. **Central lock** - foldable key
- 7. **Pencil tray** - black plastic
- 8. **Cushion SKP13** - for pedstal, order separately, max load 120kg
- 9. **Suspension files drawer** - ball runners, max load 30kg, 100% extraction, A4 folders must be inserted parallelly to the front

HPL FRONT STORAGES

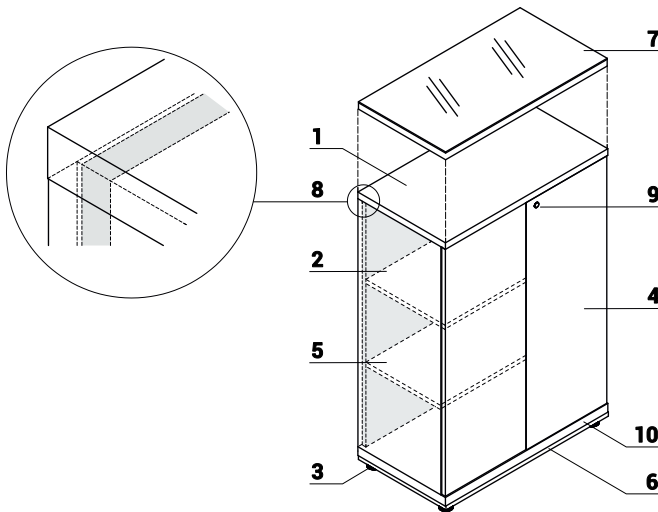

- 1. **Top** - MFC 28mm, PVC edge
- 2. **Side panels** - MFC 18mm, PVC edge
- 3. **Leveling feet 27mm** - range 12mm
- 4. **Front** - 'Push - to - Open', covered with HPL - high gloss
- 5. **Shelf** - MFC 18mm, PVC edge
- 6. **Base** - MFC 18mm, PVC edge
- 7. **Top** - MFC 28mm with LACKOBEL glass 4mm - ordered separately
- 8. **Back MFC** - 18mm, PVC edges
- 9. **Patent lock**
- 10. **Option with additional charge** - metal base - colour: M009 - aluminum semi-matte

ADDITIONAL ELEMENTS FOR STORAGE

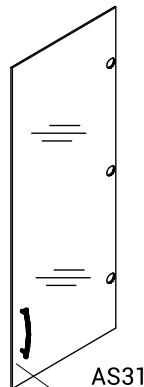
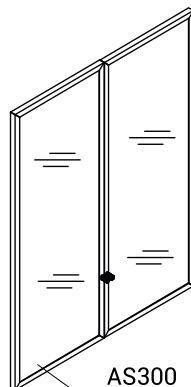
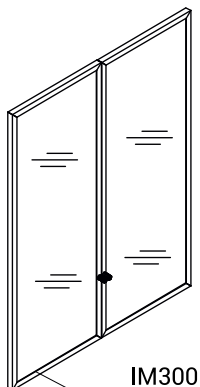

**IM300**



- glass door 30H
- transparent tempered glass 4mm, with aluminum frame

**AS300**



- glass door 30H
- frosted tempered glass 4mm, with aluminum frame

**AS31**

- glass door 30H
- transparent tempered glass 4mm
- universal (left,right)

PRODUCT ILLUSTRATION	DIMENSIONS [mm]			INDEX SYMBOL						COMMENTS
	WIDTH	DEPTH	HEIGHT			kg	m3	pcs		



**MOBILE PEDESTAL WITHOUT HANDLES WITH HPL TOP AND FRONT**

	416	600	587	<b>SLD12HT</b>		23.0	0.158	1		mobile with suspension files drawer, drawers depth - 500mm
	416	600	587	<b>SLD13HT</b>		23.0	0.158	1		drawers depth - 500mm

**PEDESTAL CUSHION**

	400	600	52	<b>SKP13</b>		3.0	0.017	1		
---	-----	-----	----	--------------	--	-----	-------	---	--	--

**ADDITIONAL CHARGE**



FEATURE	PRODUCT													COMMENTS
	SLD12HT	SLD13HT	SKP13								kg	m3	pcs	
II PRICE GROUP											0.9	0.0070	1	
III PRICE GROUP											0.0	0.0000	0	
SELF CLOSING SYSTEM											1.0	0.0010	1	
BALL RUNNERS											1.0	0.0010	1	

DESCRIPTION







 - NET WEIGHT

 VOLUME





 NUMBER OF PACKAGES

PRODUCT ILLUSTRATION	DIMENSIONS [mm]			INDEX SYMBOL						COMMENTS
	WIDTH	DEPTH	HEIGHT			kg	m3	pcs		

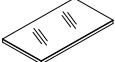

HPL FRONT STORAGES

	801	432	777	A2104HZ		35.0	0.093	3		
	801	432	1129	A3404HZ		40.0	0.111	3		
	801	432	1129	A3104HZ		44.0	0.120	3		
	801	432	1833	A5404HZ		65.0	0.189	3		
	801	432	1833	A5104HZ		75.0	0.216	3		
	801	432	1833	A52P4H		0.0	0.001	0		wardrobe/storage cabinet with slide-out hanger

ADDITIONAL ELEMENTS

	800	432	33	A800GT		8.0	0.017	1		glass + mfc
	397	5	1050	AS31		6.5	0.034	1		universal glass door (1pcs) 3OH, transparent tempered glass
	800	20	1050	AS300		10.3	0.037	1		glass doors (2pcs) 3OH aluminum frame, frosted tempered glass
	800	20	1050	IM300		10.0	0.039	1		glass doors (2pcs) 3OH aluminum frame, transparent tempered glass

ADDITIONAL CHARGE

FEATURE	PRODUCT										COMMENTS
	A2104HZ	A3404HZ	A3104HZ	A5404HZ	A5104HZ	A52P4H		kg	m3	pcs	
METAL KICK PLATE								0.0	0.0000	0	

DESCRIPTION

 - NET WEIGHT

 VOLUME

 NUMBER OF PACKAGES