



FAM130CS
Satin finish

General description

- Non-refrigerated wall-mounted drinking water fountain with connection to the mains, made of bacteriostatic AISI 304 stainless, 1.2 mm thick, satin finish.
- Ideal solution for public spaces such as waiting rooms, schools, universities, shopping centers, airports, sport facilities, factories, etc. Model suitable for public use with high strength and durability.
- Easily connected to the water mains, it provides a constant supply of water at room temperature.
- Designed to offer maximum hygiene and easy maintenance, this water drinking fountain feature softly rounded corners to prevent injury and a contoured bowl designed to minimize splashing.
- Equipped with a heavy-duty chrome plated brass faucet bubbler, instant shut-off and adjustable flow rate, inlet M3/8".
- Flat perforated waste, without screws: easy to clean and vandal-resistant.
- Recessed horizontal water outlet with waste outlet 1 1/4" trap.
- Supplied with fixing elements for a brick wall.

Components and materials

- **BODY:** manufactured in stainless steel AIS 304, 1.2 mm thick, satin finish. Its contoured bowl minimizes splashing.
- **FAUCET BUBBLER:** heavy-duty chrome plated brass faucet bubbler, instant shut-off and adjustable flow rate, inlet M3/8".

Technical specifications

Stainless Steel thickness	1.2 mm
Water inlet	3/8"
Eater outlet	Ø 1 1/4"
Net weight	2.4 Kg

Dimensions

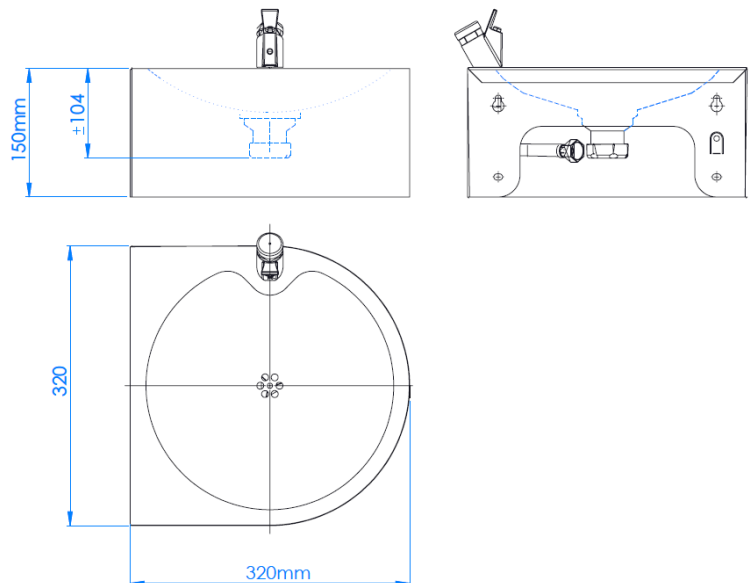

Dimensions ± 4%

Mounting

Fix the wash basin on the wall using the supplied stainless steel screws through the corresponding holes, points indicated by an "S" in the following figure:

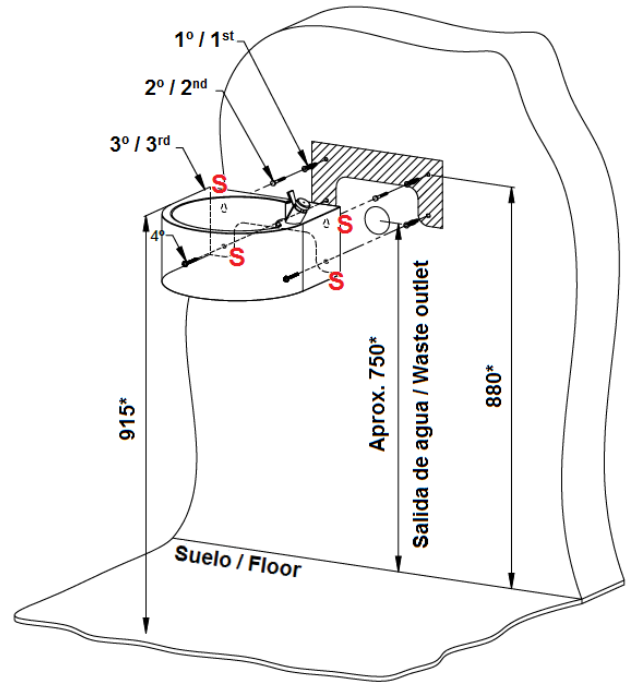
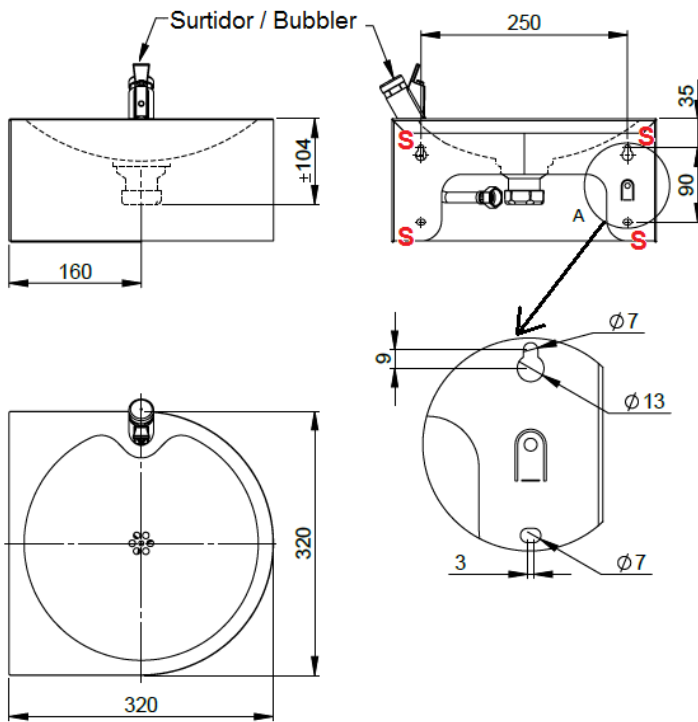

* Recomendado / Recommended

Mediclinics, S.A., reserves the right to make changes and/or modifications to the products and their specifications without prior notice
Review 02-21 © mediclinics S.A.

