

Work happily



V1.0

naggura'swop

naggura.com

# Our products

## Beauty

S502WHITE



S502GREY

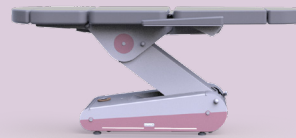

The Swop 502 is a 4-engine beauty bed of optimum stability and ultra-compact frame.

Wood, Metal or Pmma

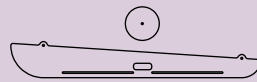

# Collections

Nordic  
METAL

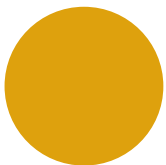

Yellow

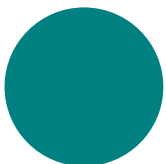

Blue

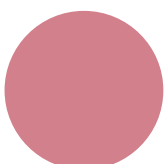

Pink

Foll  
METAL

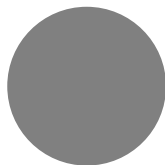

Ash

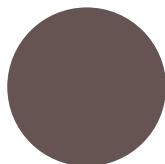

Clay

Iron  
METAL

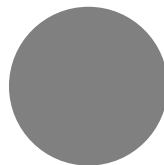

Inox

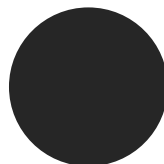

Black

Om  
WOOD



Oak



Wenge

Techno  
PMMA



Fluor

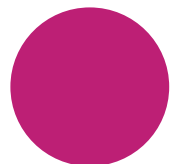

Fuxia



Ice



# S502

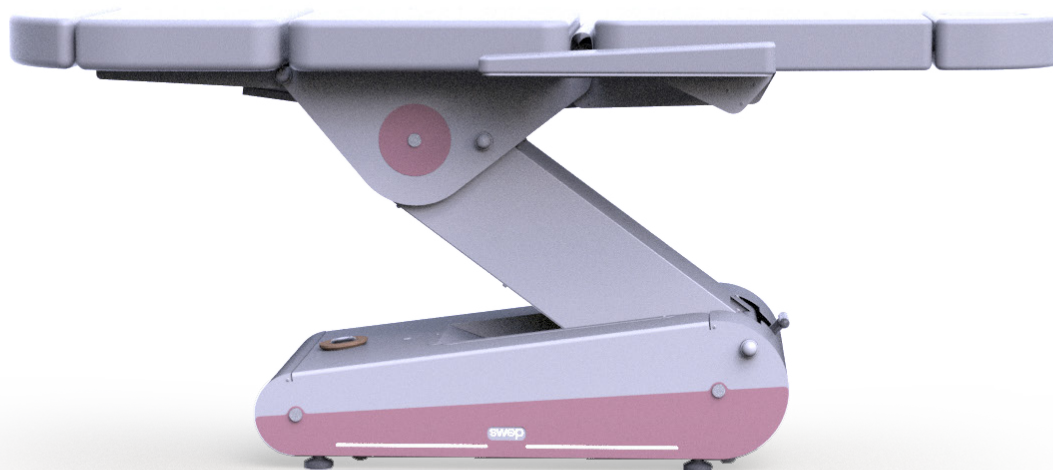
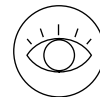

## Dimensions

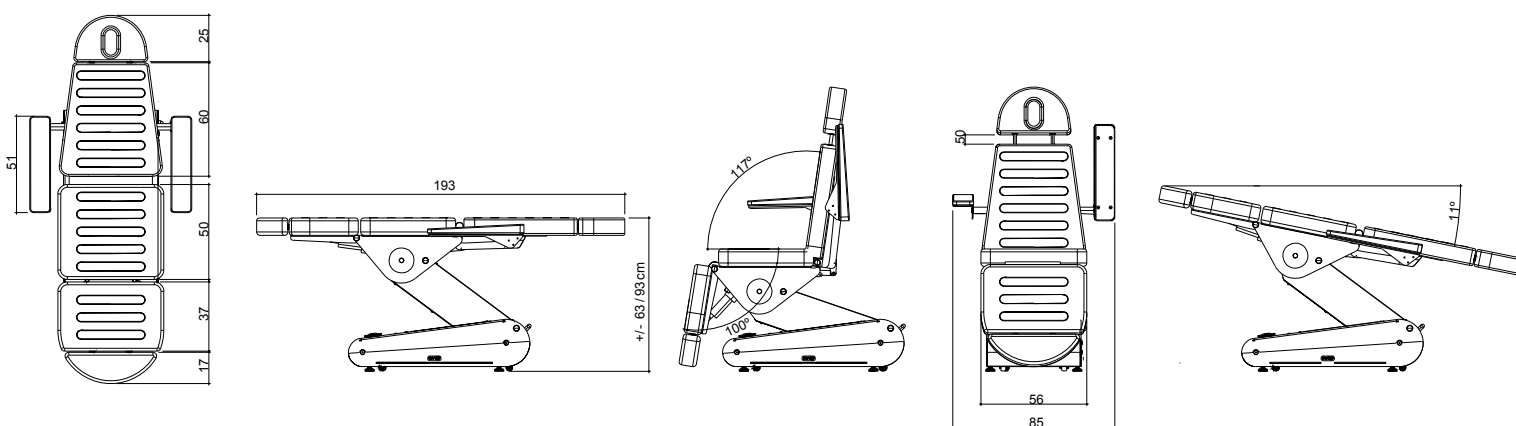

## General Specifications

MOTORS  
4 engines

DIMENSIONS (LENGTH X WIDTH)  
193 x 85 cm

HEIGHT (MIN. AND MAX.)  
63/93 cm

WEIGHT  
105 kg

THICKNESS  
10 cm

DENSITY  
30 kg/m<sup>3</sup>

LIFTING CAPACITY  
175 kg

OPERATION  
Hand controller (included)/  
Foot controller (optional)

POWER SUPPLY  
230 V - 50/60 Hz

MAX. INTENSITY  
2 A

ELECTRIC MOTOR  
6.000 N

CUSHION

100% Vinyl-compound

Permablok 3 advanced vinyl protection (against germs, abrasion), UV resistant, superior abrasion 300K Grey colour

Permaguard advanced vinyl protection (against germs and stains), UV resistant, abrasion 100K White colour