

# Ogi Drive technical specification



**.mdd**

**.mdd has a leading position among manufacturers of office furniture with many awards that prove quality and continuously increase demand for its products.**

The realities of today's market require constant quality improvement at all levels of modern organization. This applies in particular to customer service, marketing, quality of products and also to quality of processes within the company.

Partnership relations among employees and with business partners form a base of economic growth and success of the company.

Constant investments in innovative machinery park, optimization of management systems and an expansion of production halls allow to minimize the lead times for the product of the highest quality.

**More than twenty years of experience in office furniture industry come with reference from a long list of companies and institutions to show their appreciation for an efficient and comprehensive service.**

**.mdd is highly aware of the environment.**

Being located in the forest region with lake by its side, .mdd takes the nature seriously and invests constantly in a modern and energy-efficient solutions to preserve the local life. Company puts emphasis on waste segregation and recycling. .mdd has been awarded for the exceptional care and involvement in waste disposal. All materials used are environmentally friendly and enjoy a high 95 % rate of being recycled.



## General informations:

### Warranty:

.mdd products – **5 years**.

Electrical components and fabric – **2 years**.

### Certificate - MFC:



### Assembly:

product delivered in separate elements

### Packing:

cardboard

### Compliant with standards:

DIN EN 13849-1:2007, Performance Level B;

RoSH 2011/65/UE;

LVD; EU Directive 2006/95/EC;

EMC according to EU Directive 2004/108/EC;

PN-EN 55014-1:2017-06;

PN-EN 55014-2:2015-06;

PN-EN 60204-1:2010P;

PN-EN 61000-1-2:2016-11;

PN-EN 61000-6-3:2008/A1:2012;

PN-EN 60335-1:2012;

PN-EN-ISO-12100\_2012P

### Boards density:

12 mm – 690 – 750 kg/m<sup>3</sup>

18 mm – 650 – 690 kg/m<sup>3</sup>

28 mm – 610 – 630 kg/m<sup>3</sup>

36 mm – 610 – 630 kg/m<sup>3</sup>

## Ogi desk worktops

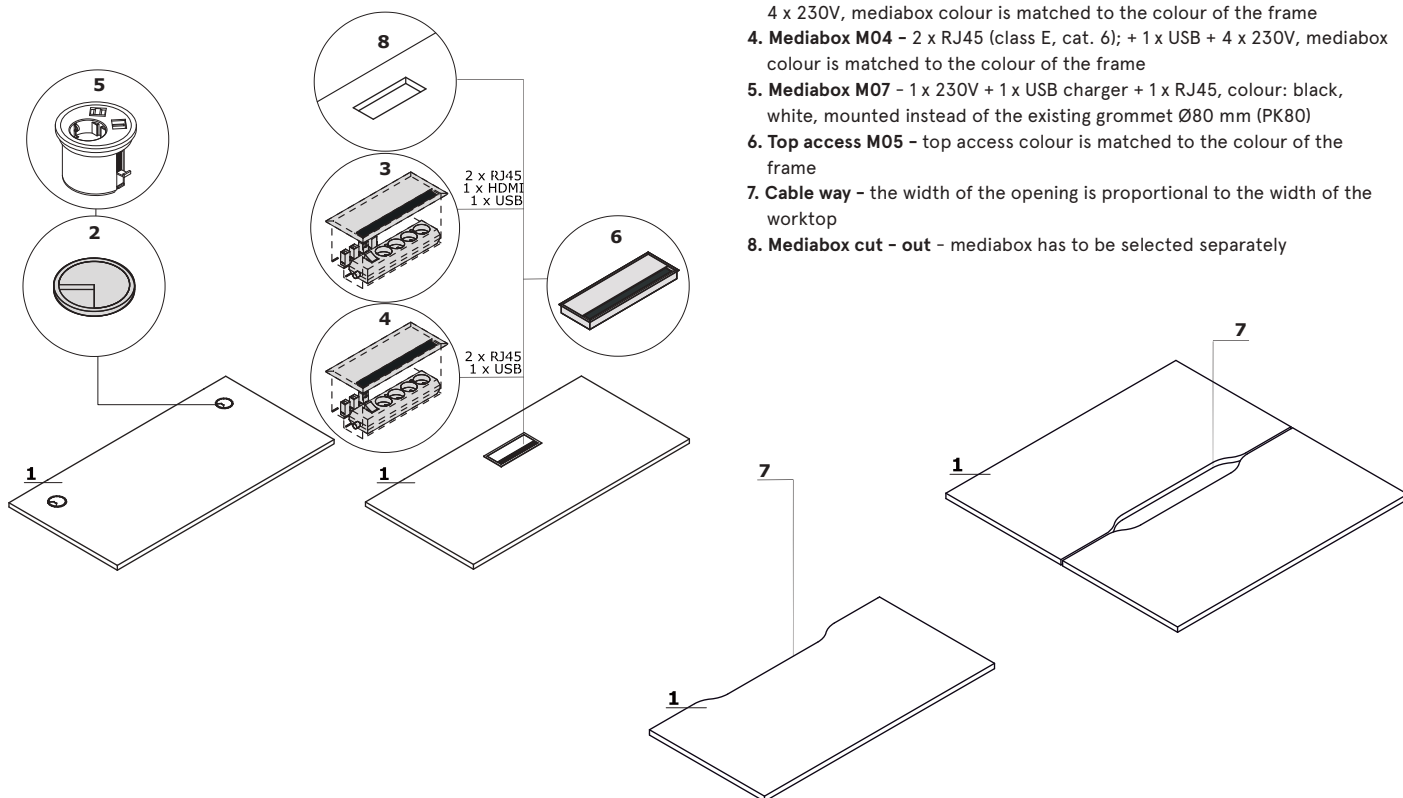

1. **Worktop** - MFC 28 mm, ABS edge

**OPTIONS WITH EXTRA CHARGE:**

2. **Grommet** - 2 pcs, Ø 80 mm

3. **Mediabox M04H** - 2 x RJ45 (class E, cat. 6); + 1 x USB + 1 x HDMI + 4 x 230V, mediabox colour is matched to the colour of the frame

4. **Mediabox M04** - 2 x RJ45 (class E, cat. 6); + 1 x USB + 4 x 230V, mediabox colour is matched to the colour of the frame

5. **Mediabox M07** - 1 x 230V + 1 x USB charger + 1 x RJ45, colour: black, white, mounted instead of the existing grommet Ø80 mm (PK80)

6. **Top access M05** - top access colour is matched to the colour of the frame

7. **Cable way** - the width of the opening is proportional to the width of the worktop

8. **Mediabox cut - out** - mediabox has to be selected separately

## Frame

1. **Ogi Drive with electric height adjustment** - in the range of 650-1300 mm, metal, powder coated, 3 profiles 50 × 50 mm, 55 × 55 mm and 60 × 60 mm

2. **Ogi Drive with electric height adjustment** - in the range of 700-1200 mm, metal, powder coated, 2 profiles 55 × 55 mm and 60 × 60 mm

3. **OPTION WITH EXTRA CHARGE - Yan T foot:**

- aluminium powder coated

- polished aluminium

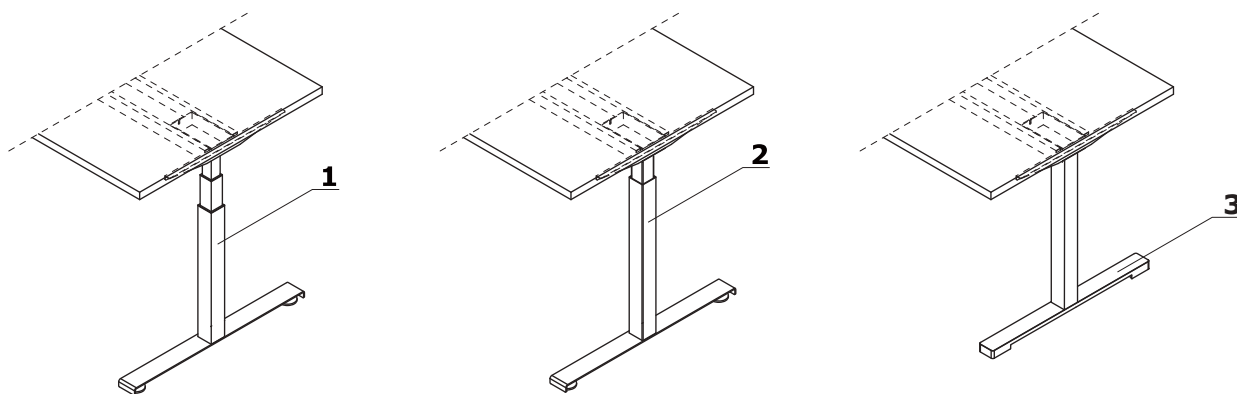

## Electric height adjustable frame - Ogi Drive

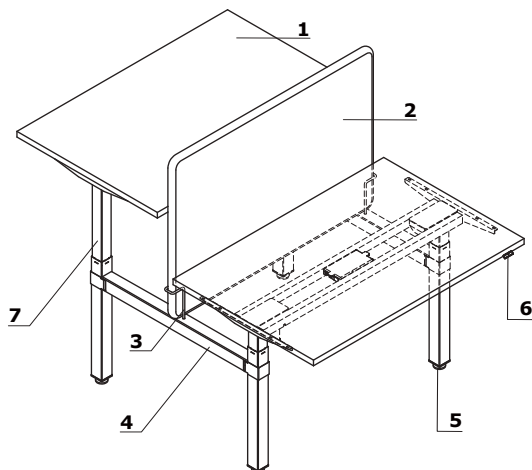

ATTENTION - distance between bench worktops 90 mm

1. **Worktop** - MFC 28 mm, ABS edge
2. **ZD Panel** - acoustic class A, zip fastener, pinable
3. **Fixing element** - powder coated metal
4. **Metal element for legs connecting**
5. **Leveling feet** - range 5 mm
6. **Control panel** - stepless height adjustment:
  - A - basic control panel; the sensitivity of the anti-collision system is set to Medium
  - B - OPTION WITH EXTRA CHARGE - up and down keypad with memory; the ability to change the sensitivity of the anti-collision system within 3 levels: Low, Medium, High
  - C - OPTION FOR AN ADDITIONAL COST - bluetooth module:
    - \* compatible with both panel A and B
    - \* the ability to change the sensitivity of the anti-collision system within 3 levels: Low, Medium, High
    - \* control via MDD Desk BT application (downloadable from Google Play or App Store). The app has a time interval function that informs the user about the need of changing body position (from sitting to standing or standing to sitting)
7. **Electric height adjustable frame** - powder coated steel, load 100 kg, telescopic leg

A

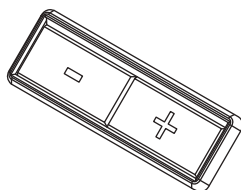

B

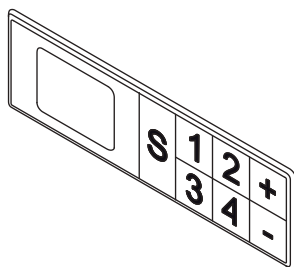

C

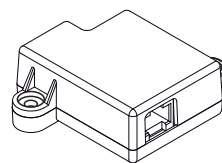

## Frame technical specification

- **Height adjustment** - 40 mm/sec Super Soft Start - Stop
- **Drive** - 2 synchronised motors with microprocessor, work control sensor
- **Noise level** - < 48dB
- **Anti collision mechanism**
- **Standards** - EN 527-2
- **EU Directives** - 206/95EC, UI508 1999, UL 1004 R7 06, WE DC 2004/108WE Stand - by mode 0.3 W
- **Power supply** - 230V, 256W

Ogi Drive	Date of preparation 09.08.2021	The data contained in this document is valid in the day of its preparation. Change of the product, as long as it does not affect the basic features of it, does not require consistent updates of the document.	page 4/13 technical description
-----------	-----------------------------------	---	------------------------------------

## Electric frame with common cable tray - Ogi Drive

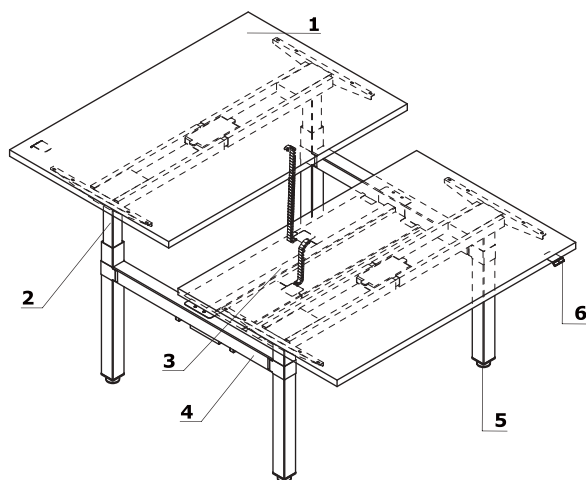

1. **Worktop** - MFC 28 mm, ABS edge
2. **Electric height adjustable frame** - powder coated steel, load 100 kg, telescopic leg
3. **Common cable tray + vertical cable organizer**
4. **Metal element for legs connecting**
5. **Leveling feet** - range 5 mm
6. **Control panel** - stepless height adjustment:
  - A - basic control panel
  - B - OPTION WITH EXTRA CHARGE - up and down keypad with memory
  - C - OPTION FOR AN ADDITIONAL COST - bluetooth module - compatible with control panel A and B - control via MDD Desk BT application (downloadable from Google Play or App Store). The app has a time interval function that informs the user about the need of changing body position (from sitting to standing or standing to sitting)

## Mediabox location

- A - left mediabox
- B - left/right mediabox
- C - right mediabox

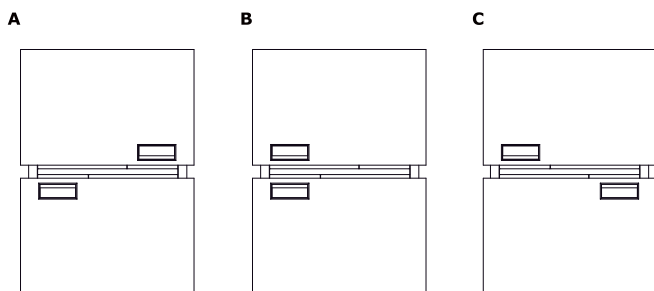

www.mdd.eu

## Accessories

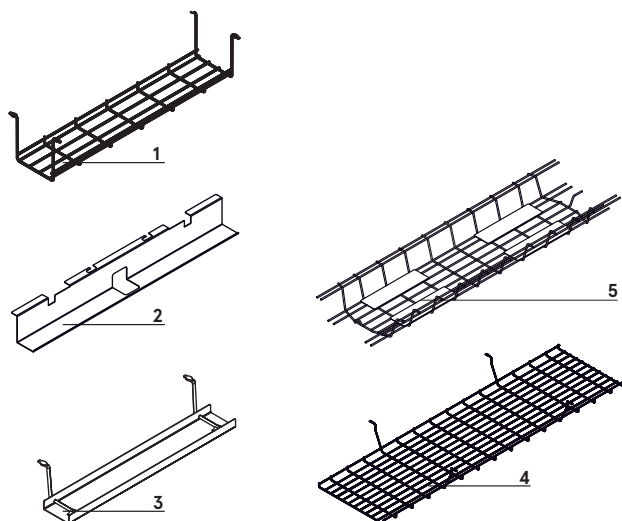

1. **Horizontal cable tray S69** - powder coated, colour: 09 - aluminum
2. **Single desk horizontal cable tray (SG12, SG16)** - powder coated metal, colour: M009 - aluminum semi-matt
3. **Horizontal cable tray E64** - powder coated, colour: M009 - aluminium semi-matt
4. **Cable tray for bench desks Ogi Drive (SOD12, SOD14, SOD16, SOD18, SOD20)** - powder coated, colour: M009 - aluminium semi-matt
5. **Cable tray for bench desks (SG220, SG260)** - steel wire Ø4 mm, powder coated, colour: 09 - aluminum

Ogi Drive	Date of preparation 09.08.2021	The data contained in this document is valid in the day of its preparation. Change of the product, as long as it does not affect the basic features of it, does not require consistent updates of the document.	page 5/13 technical description
-----------	-----------------------------------	---	------------------------------------

### Ogi Drive handle - dimensions (mm)

1. Ogi Drive screen bracket - an option with extra charge; mountable to the frame; powder-coated metal, 60x60mm profile

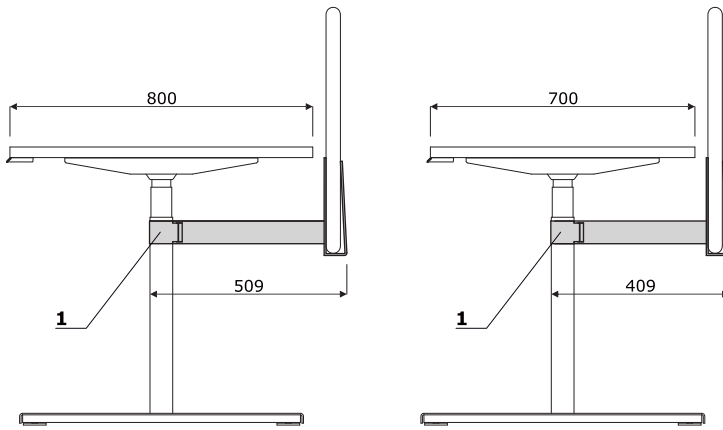

Caution - Ogi Drive screen bracket does not allow for pairing with screens equipped with accessories rail.

Simple desks electric height adjustment in the range of 700-1200 mm - sit-stand \*



**BOD527**  
1200 / 700 / 700-1200  
42.1 kg



**BOD547**  
1400 / 700 / 700-1200  
45.8 kg

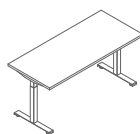

**BOD567**  
1600 / 700 / 700-1200  
49.3 kg

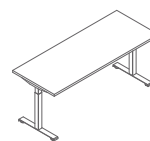

**BOD587**  
1800 / 700 / 700-1200  
53.3 kg

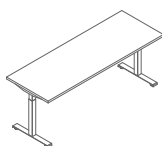

**BOD607**  
2000 / 700 / 700-1200  
57.3 kg

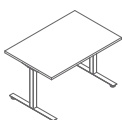

**BOD52**  
1200 / 800 / 700-1200  
45.65 kg

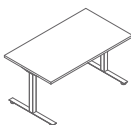

**BOD54**  
1400 / 800 / 700-1200  
49.6 kg

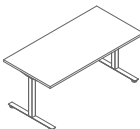

**BOD56**  
1600 / 800 / 700-1200  
54.15 kg

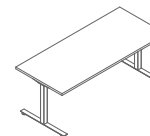

**BOD58**  
1800 / 800 / 700-1200  
58.45 kg

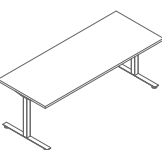

**BOD60**  
2000 / 800 / 700-1200  
62.25 kg

\* dimensions expressed in millimeters: width x depth x height

Single desks with electric height adjustment in the range of 650-1300 mm - sit-stand \*

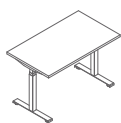

**BOD627**  
1200 / 700 / 650-1300  
424.63 kg

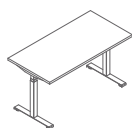

**BOD647**  
1400 / 700 / 650-1300  
48.33 kg

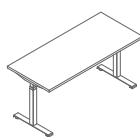

**BOD667**  
1600 / 700 / 650-1300  
51.83 kg

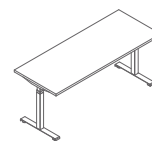

**BOD687**  
1800 / 700 / 650-1300  
55.83 kg

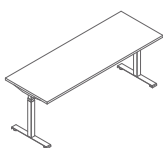

**BOD707**  
2000 / 700 / 650-1300  
59.83 kg



**BOD62**  
1200 / 800 / 650-1300  
48.18 kg

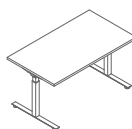

**BOD64**  
1400 / 800 / 650-1300  
52.13 kg

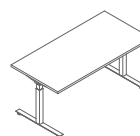

**BOD66**  
1600 / 800 / 650-1300  
56.68 kg

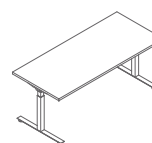

**BOD68**  
1800 / 800 / 650-1300  
60.98 kg

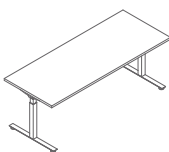

**BOD70**  
2000 / 800 / 650-1300  
64.78 kg

\* dimensions expressed in millimeters: width x depth x height



Bench desks with electric height adjustment in the range of 700-1200 mm - sit-stand \*

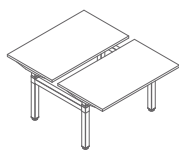

**BOD572**  
1200 / 1490 / 700-1200  
83.2 kg

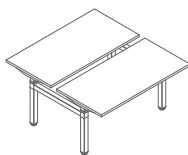

**BOD574**  
1400 / 1490 / 700-1200  
89.6 kg

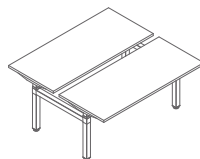

**BOD576**  
1600 / 1490 / 700-1200  
95.6 kg

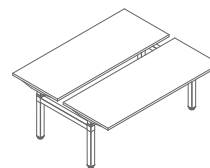

**BOD578**  
1800 / 1490 / 700-1200  
102.6 kg

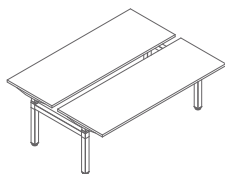

**BOD570**  
2000 / 1490 / 700-1200  
109.6 kg

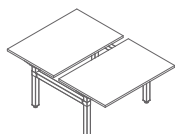

**BOD512**  
1200 / 1690 / 700-1200  
90.8 kg

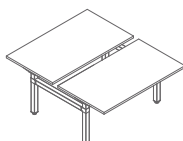

**BOD514**  
1400 / 1690 / 700-1200  
97.7 kg

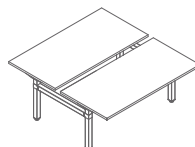

**BOD516**  
1600 / 1690 / 700-1200  
105.8 kg

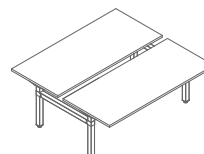

**BOD518**  
1800 / 1690 / 700-1200  
113.4 kg

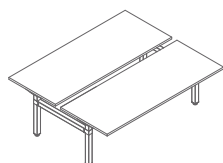

**BOD520**  
2000 / 1690 / 700-1200  
120 kg

\* dimensions expressed in millimeters: width x depth x height

Bench desks with electric height adjustment in the range of 650-1300 mm - sit-stand \*

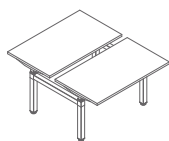

**BOD672**  
1200 / 1490 / 650-1300  
88.26 kg

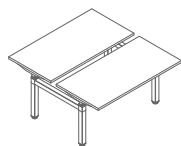

**BOD674**  
1400 / 1490 / 650-1300  
94.66 kg

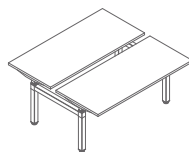

**BOD676**  
1600 / 1490 / 650-1300  
100.66 kg

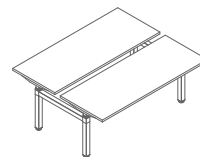

**BOD678**  
1800 / 1490 / 650-1300  
107.66 kg

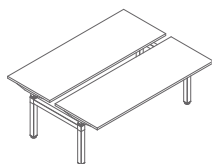

**BOD670**  
2000 / 1490 / 650-1300  
114.66 kg

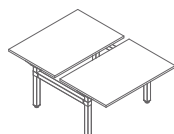

**BOD612**  
1200 / 1690 / 650-1300  
95.86 kg

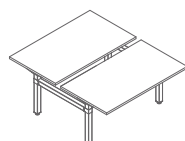

**BOD614**  
1400 / 1690 / 650-1300  
102.76 kg

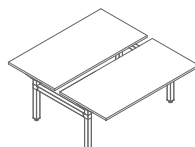

**BOD616**  
1600 / 1690 / 650-1300  
110.86 kg

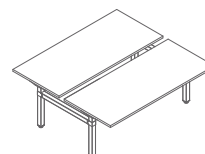

**BOD618**  
1800 / 1690 / 650-1300  
118.46 kg

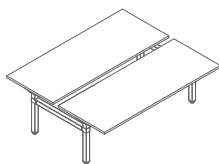

**BOD620**  
2000 / 1690 / 650-1300  
125.06 kg

\* dimensions expressed in millimeters: width x depth x height

Bench desks with common cable tray \*

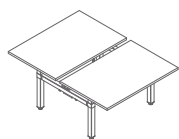

**BOD712**  
1200 / 1690 / 700-1200  
97.8 kg

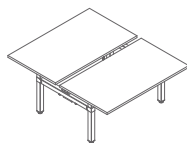

**BOD714**  
1400 / 1690 / 700-1200  
106.2 kg

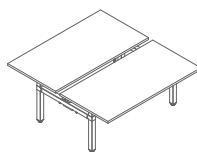

**BOD716**  
1600 / 1690 / 700-1200  
115.8 kg

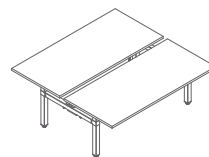

**BOD718**  
1800 / 1690 / 700-1200  
124.4 kg

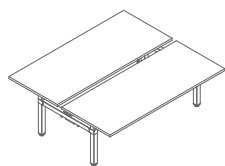

**BOD720**  
2000 / 1690 / 700-1200  
133 kg

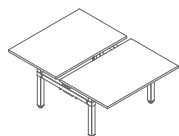

**BOD812**  
1200 / 1690 / 650-1300  
102.86 kg

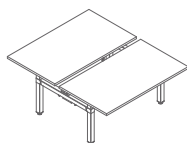

**BOD814**  
1400 / 1690 / 650-1300  
111.26 kg

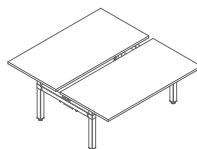

**BOD816**  
1600 / 1690 / 650-1300  
120.86 kg

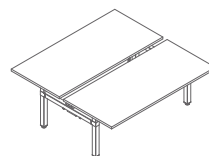

**BOD818**  
1800 / 1690 / 650-1300  
129.46 kg

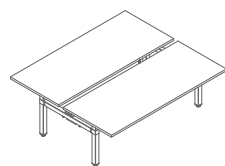

**BOD820**  
2000 / 1690 / 650-1300  
138.06 kg

\* dimensions expressed in millimeters: width x depth x height

Sonic - acoustic screens for bench desks \*

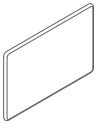

**ZD812**  
1190 / 40 / 800  
13.6 kg

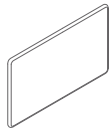

**ZD814**  
1390 / 40 / 800  
8.6 kg

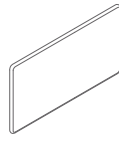

**ZD816**  
1590 / 40 / 800  
7.4 kg

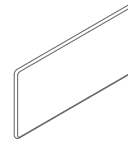

**ZD818**  
1790 / 40 / 800  
8.9 kg

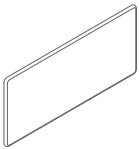

**ZD820**  
1990 / 40 / 800  
9.1 kg

\* dimensions expressed in millimeters: width x depth x height

<b>Ogi Drive</b>	Date of preparation 09.08.2021	The data contained in this document is valid in the day of its preparation. Change of the product, as long as it does not affect the basic features of it, does not require consistent updates of the document.	page 12/13
			<b>products</b>

**Worktop**



26 Aluminum satinato



31 Canadian oak \*



39 Polar birch \*



64 Cocoa \*



168 Natural oak \*



169 Honey oak\*



170 Acacia \*



67 White pastel



171 Dark walnut\*



106 Lowland walnut \*



154 Anthracite



08 Black



167 Grey oak \*

**Grommet**



Aluminum



Beige



White



Black

**Frame, mediabox - metal**



M009 Aluminum semi-matt  
RAL9006



M015 White semi-matt  
RAL9010



M154 Antracite semi-matt  
RAL7043



M115 Black semi-matt  
RAL9005

**Foot Yan Drive - metal**



M009 Aluminum semi-matt  
RAL9006



M015 White semi-matt  
RAL9010



M154 Antracite semi-matt  
RAL7043



M115 Black semi-matt  
RAL9005



25 Polished aluminum