

Instructions Manual

For Models: STE-18-D Pro
STE-23-D Pro

Thank you for choosing our steam sterilizer.

Prior to operating this instrument, please read the operations manual carefully and follow all installation instructions.

Ningbo Ican Machines Co., Ltd.
No. 77 Yunlin East Road, Gulin Town,
Ningbo, China.
www.icanclave.com

European Representative:
Icanclave Europe S.L
Juan Ramon Jimenez 6
Quart de Poblet, Valencia, Spain.

Document: Version 00DP0000V2.9
Subject to technical changes

Save these instructions

Content

| | | |
|----------------------------------|----|---|
| 1. General | 4 | 4 Scope of manual 4 Intended use 4 General safety instructions 4 Standards and directives 5 Symbols |
| 2. Description of the sterilizer | 5 | 5 Control panel 6 Sterilizer views 7 Technical specification 7 Packing content |
| 3. Installation | 7 | 7 General conditions 8 Power supply connection 8 Location requirements |
| 4. Setup | 8 | 8 Fill the distilled water tank 9 Preparation of the sterilization materials 10 Basic set 10 Advance set |
| 5. Operation | 13 | 13 Load the sterilization chamber 13 Select the program 13 Start the sterilization program 14 End of cycle 14 Manually interruption of the cycle 15 Delay start cycle 15 Test Program 16 Descale 16 Data 17 Print and save report (Optional) 18 Print Labels (Optional) |
| 6. Maintenance | 18 | 18 Clean the distilled water tank 18 Replacement of the bacteriological filter 19 Clean Chamber, trays and tray Rack 19 Door adjustment 19 Replacement of the door seal ring 19 The drain valve |
| 7. Troubleshooting | 20 | 20 Troubleshooting |
| 8. Transportation and storage | 21 | 21 Transportation and storage conditions |
| 9. Safety devices | 21 | 21 Safety device description |
| 11. Appendix | 22 | 22 Water properties/characteristics 23 Diagrams of the sterilization programs |

1 General

Scope of Manual

This manual contains information concerning the installation, operation and maintenance of the steam sterilizers. To ensure proper performance of the sterilizer, the instructions given in this manual should be thoroughly understood and followed. Keep the manual near the sterilizer in an accessible location for future reference.

Intended Use

The steam sterilizer described in this manual is intended for the sterilization in all medical, dental, beauty, vet and tattoo fields of the following types of instrument loads: solid, porous, hollow loads type A and hollow loads type B, un-wrapped, single wrapped and double wrapped, liquid, that are compatible with steam sterilization.

General Safety Instructions

- Read and understand this manual before attempting to install or operate the sterilizer.
- Make sure that all the installation conditions are fully complied with.
- Ensure that the voltage agrees with the supply voltage specified on the supply on the type plate of the sterilizer.
- This appliance must be grounded. Connect only to a properly grounded outlet.
- Do not cover or block any openings on this appliance.
- Use this appliance only for its intended use as described in this manual.
- Do not exceed the maximum weight limit of the loads specified in this manual.
- Do not operate this appliance if it has a damaged cord or plug if it is not working properly or if it has been damaged or dropped.
- Never put into the sterilizer inflammables or explosive products.
- The sterilizer may not be operated in areas in which gas or any other explosive volatile substance is present.
- Installation and repair work should only be performed by authorized service technicians. Work by unqualified persons could be dangerous and may void the warranty.

Standards and directives

The steam sterilizers were designed and produced in conformity with the following directives and standards:

Directives:

97/23/CE Pressure equipment.
93/42/EEC Medical devices (class II b).

Standards:

EN 13060 Relative to small steam sterilizers.
EN 61010-1 Safety regulations for laboratory devices - Part 1: General regulations.
EN 61010-2-040 Safety regulations specific to sterilizers used in the processing of medical material.
EN 61326-1 Electromagnetic compatibility regulations for laboratory devices.

Symbols

For safe operation, please pay close attention to the alert symbols below which can be found on the sterilizer and throughout this manual.



Important information (Caution) connection



Hot surface



Ground

2 Description of the sterilizer

Screen and Control panel

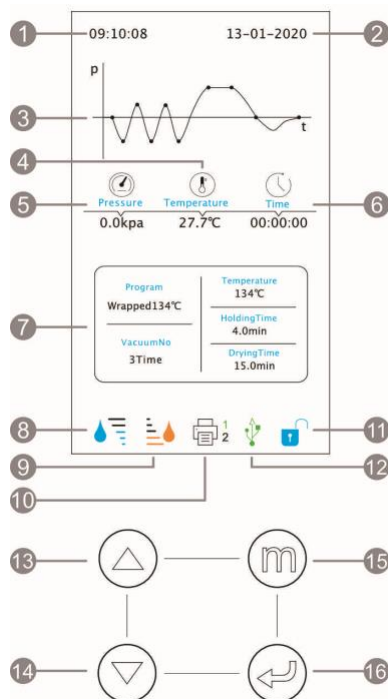

- 1 Time
- 2 Date
- 3 Process curve
- 4 Internal temperature
- 5 Internal pressure
- 6 Cycle time
- 7 Program information
- 8 Clean water tank level
- 9 Used water tank level
- 10 Printers
- 11 Door status
- 12 USB memory
- 13 Up button
- 14 Down button
- 15 Select button
- 16 Start button



Door closed / Tap to open the door



The door is open



Fill the tank if it is flashing

Min level of freshwater tank 0.5Liters



Drain the tank if it is flashing

The capacity is 1.5 liters



1 Report printer

Grey = No connected / no paper
Green =Ready



USB memory

Grey = No connected
Green =Ready

Sterilizer views

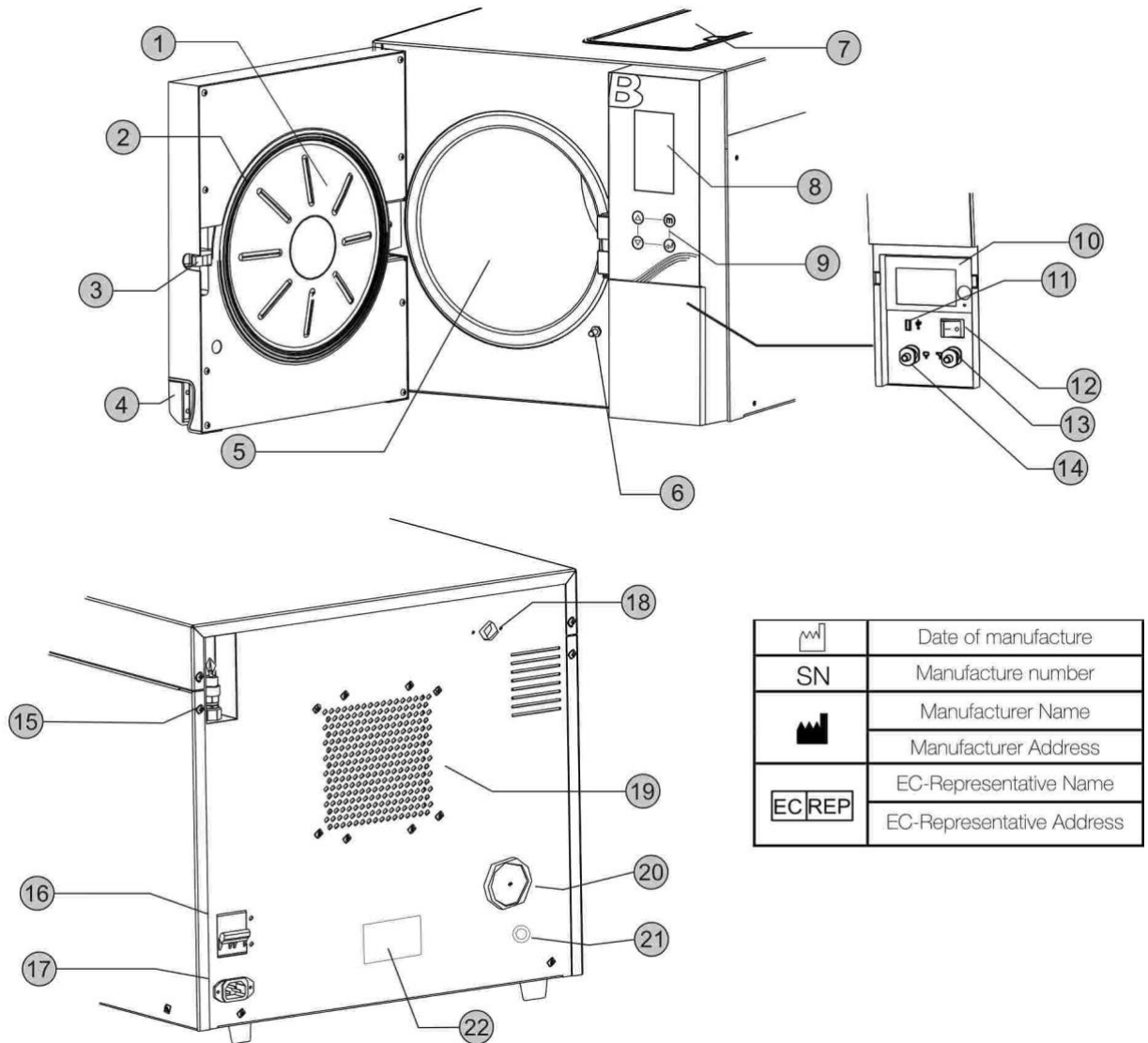





- | | | |
|-------------------------|-------------------------------|------------------------------------|
| 1. Door | 9. Touch pad | 17. Power socket |
| 2. Door seal ring | 10. Printer | 18. Steam vent |
| 3. Door lock | 11. USB port | 19. Condenser vent |
| 4. Door handle | 12. Main switch | 20. Bacterial filter |
| 5. Chamber | 13. Distilled water tank vent | 21. Used water tank vent(optional) |
| 6. Door interlock | 14. Used water tank vent | 22. Rating plate |
| 7. Distilled water tank | 15. Safety valve | |
| 8. Screen | 16. Circuit breaker | |

Technical specifications

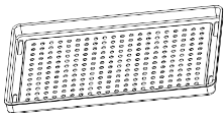
| Model | STE-18-D Pro | STE-23-D Pro |
|--------------------------------------|-------------------------------------|----------------------|
| Chamber (mm) | 250 x 350 | 250 x 450 |
| Overall dimensions (mm) | 490(W)*455(H)*600(D) | 490(W)*455(H)*690(D) |
| Net Weight (kg) | 50 | 53 |
| Nominal power (VA) | 1750 | 1750 |
| Rated Voltage | 220-240V / 110-120V ; 50/60 Hz | |
| Sterilization temperatures | 121°C/134°C | |
| Capacity of the distilled water tank | 2.5 L (Water at level Max.) Approx. | |
| | 0.5L (Water at level Min.) Approx. | |
| Circuit breaker | F16A /400 V | |
| Operation temperature | 5°C ~ 40°C | |
| Operation relative humidity | Max. 80%, non-condensing | |
| Max. Noise level | <70 dB | |
| Atmospheric pressure | 76 kPa ~ 106 kPa | |

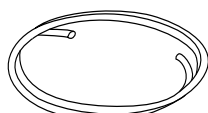
Packing content

| Item | Accessories | Quantity |
|------|---|----------|
| 1 | Instruments tray  | 3 |
| 2 | Instruments tray rack  | 1 |
| 3 | Draining hose  | 2 |
| 4 | Door Seal  | 1 |
| 5 | Tray handle | 1 |
| 6 | Door adjustment wrench | 1 |
| 7 | Instructions Manual | 1 |

3 Installation

General conditions

- Position the device on a plane surface with a minimum capacity of 60 kgs.
- The sterilizer should be placed on a level worktable.
- Leave at least 10 cm between the device rear part and the wall. The clearance required to open the door is 40cm.
- Position the sterilizer at such a height as to make it possible for the operator to check the whole sterilization chamber and carry out the normal cleaning operations.
- The room where the device is installed must be sufficiently ventilated.

- Do not install the device near washing basins, taps, etc. where it is likely to be splashed.
- Do not lean on the door when it is opened.
- Do not place trays, papers, fluid containers or other objects on the sterilizer.

Power supply connection

Check the label on the back panel of sterilizer to verify the voltage rating for the unit. Failure to connect the sterilizer to an appropriate power supply could result in damage to the unit and electrical shock to personnel.

Plug power cord into a properly polarized and grounded receptacle rated. A dedicated circuit only used for the sterilizer is recommended. Never connect the device pin to reductions of any type.

Location requirements (mm)

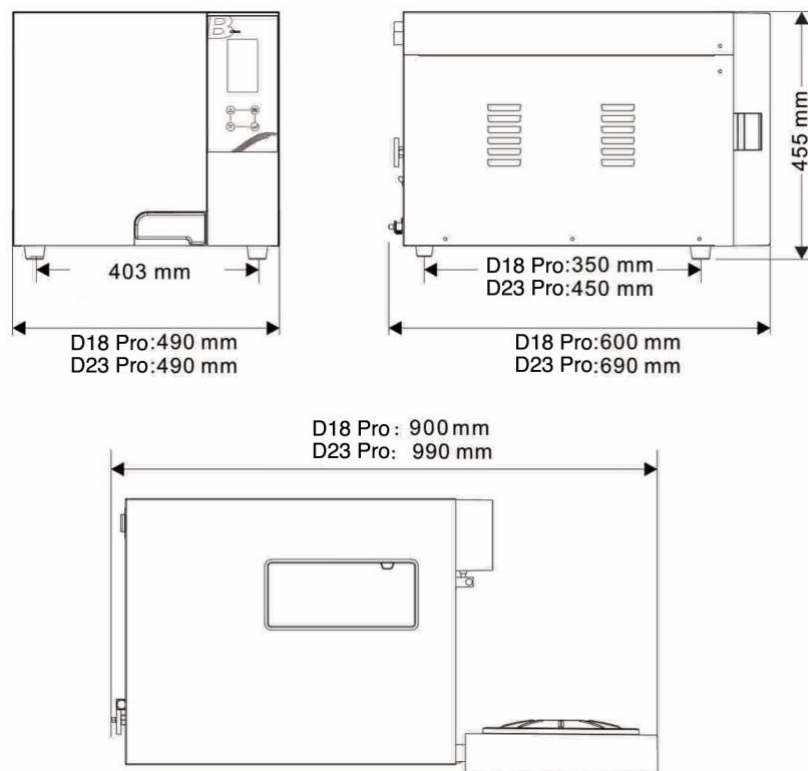

4 Setup

Switch On and open the door to remove all of the inner contents for unpacking.

Connect the power cord to an outlet of the appropriate voltage.

Turn on the main power switch on the right side. After switching on, the machine turns on the LCD and shows the door position, water level, working program, date, time, etc.

Fill the distilled water tank

Manual water filling

When the level of distilled water reaches a minimum level, the distilled water tank icon will flash and beep three times.

Press the button on the tank lid and open it to the maximum position.

Fill it carefully with distilled water.

If exceeds the maximum level, an alarm will sound, and the distilled water tank icon will blink.

Drain the distilled water tank

Attach the drain hose on a fitting connection located on the front of the sterilizer. Pull the connector to start the draining.

Attention: The capacity of the distilled water tank is approximately 2.5 liters.

Drain the used water tank

Attach the drain hose on a quick fitting connection located inside the service door at the left.

Attention: The capacity of the used water tank is approximately 2 liters.

Preparation of sterilization materials

For the most effective sterilization and to preserve the sample, please follow below:

- Clean instruments immediately after use.
- Treat the instruments by ultrasound cleaner.
- Residual chemicals left over after cleaning and disinfecting process may damage and corrode parts of the sterilizer, always rinse off the instruments using distilled water.
- Follow instrument manufacturer's guidelines and recommendations for handling and cleaning instruments prior to sterilization.
- Check the manufacturer's instructions as to proper procedure for sterilizing of each item.
- Arrange the samples of different materials on different trays or with at least 3cm of space between them.
- Clean and dry instruments thoroughly before placing them into tray.
- Always insert a sterilization paper or cloth between the tray and sample to avoid direct contact.
- Arrange the containers (glasses, cups, test-tubes, etc.) on one side or inverted position, avoiding possible water stagnation.
- Don't stack the trays one above the other or put them in direct contact with the walls of the sterilization chamber.
- Always use the instrument tray handle.
- Wrap the samples one by one or, if more tools have to be set in the same bag, verify that these are made of the same material.
- Don't use metallic clips, pins or other, as this jeopardizes the maintenance of the sterilizer.
- Don't overload the trays over the stated limit (see appendix 2).



Basic Set

The “Basic Set” menu permits to set the following options:

*Date *Time *Language

Select the “Basic Set” from the main menu by pressing  button.

Select the item by pressing  button. The unit you selected will be lighted.

Adjust the value by pressing   buttons. Press

 button to select the next item.

Press  button to save and back.

Note: The Counter (cycle No) cannot be set by the operator.

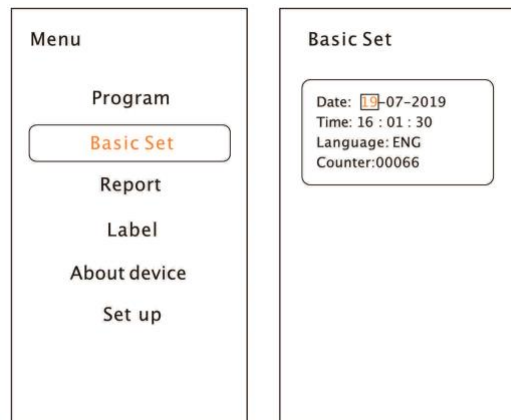





Advance Set

The “Setup” menu permits to set the following options:

*Parameter *Unit *Preheat *Expire date (labels)

*Water quality (sensor) *Preheat *Factory reset and see the information of: *Last error

Select “Setup” from the main menu by pressing  button.

Input the password digit to digit by pressing   and  button to go next.

Password: 1111

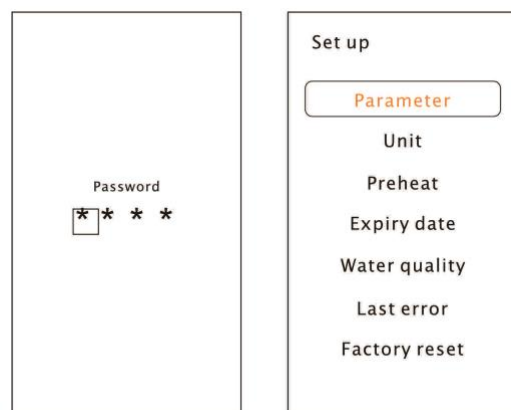







Parameter

The “Parameter” menu permits to set the following options:

*Holding time *Dry time

Select “Parameter” from the menu by pressing  button.

Select the program by pressing   then press  button.

Select the parameter by pressing  button. Adjust it by pressing  .

Press  button to save and back.

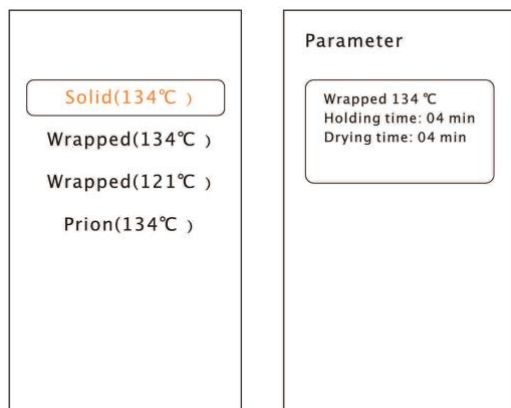

Unit

Select "Unit" from the menu by pressing (m) button.
 Select the parameter by pressing (m) button. Adjust it by pressing (▲▼).
 Press (↶) button to save and back.

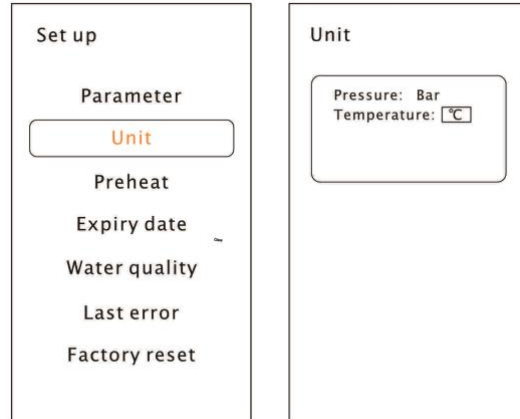

Preheat

When this mode is activated, the chamber and steam generator start to warm until it reaches the minimum temperature to begin a sterilization cycle, this helps to reduce the total cycle time and the drying efficiency. The "Preheat" mode will be deactivated after one hour of inactivity.

Select "Preheat" from the menu by pressing (m) button.
 Adjust it by pressing (▲▼).
 Press (↶) button to save and back.

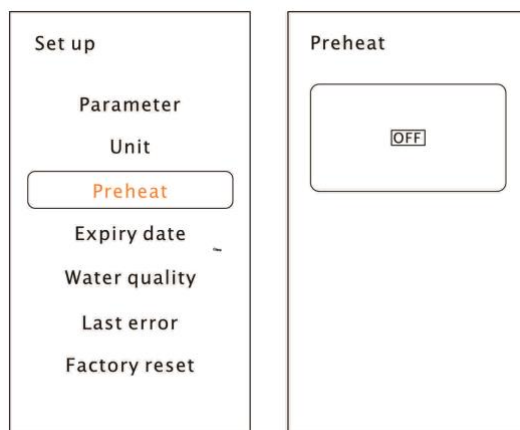

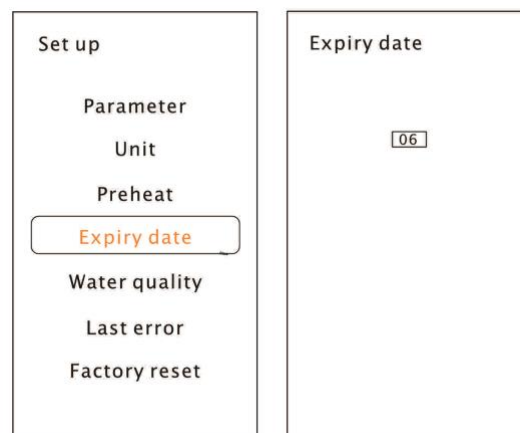

Expiry date (Optional)

To modify the expiration date of the labels, select "Expire date" from the menu by pressing (m) button.
 Adjust it by pressing (▲▼).
 Press (↶) button to save and back.



Water quality (optional)

If your sterilizer is equipped with a water quality sensor and you want to deactivate it, select "Water quality" from the menu by pressing  button.

Adjust it by pressing  .

Press  button to save and back.

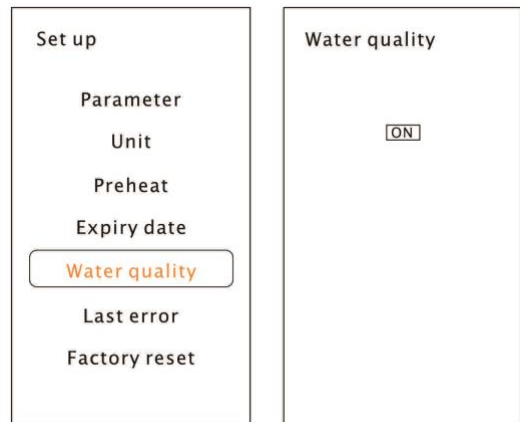

Last Error

In order to help the technical assistance process, the most relevant information corresponding to the last error can be displayed on the screen.

Select "Last error" from the menu by pressing  button.

Press  button to back.

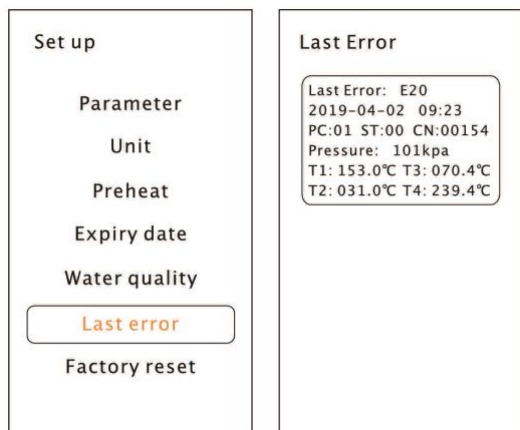

Factory reset

Select "Factory reset"

Press  "Yes" to reset all settings

Press  button to back.

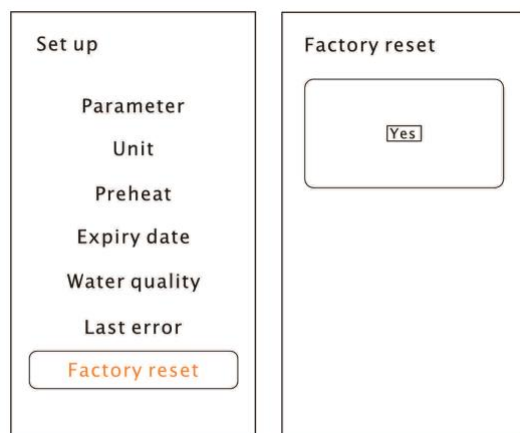



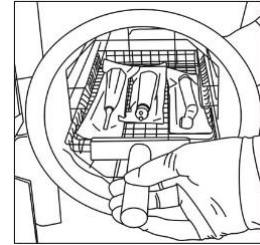

Load

After selecting program, the materials to be sterilized can now be placed on the tray and placed inside the chamber by the tray handle. After the instruments are loaded, you may close the door.



Select the program

Enter to the main menu by pressing  button, Select "Program". Select the program by pressing   then press  to confirm program, in the screen will appear the information of selected program as the temperature and sterilization time (holding time), also the date, time, current pressure and current temperature.

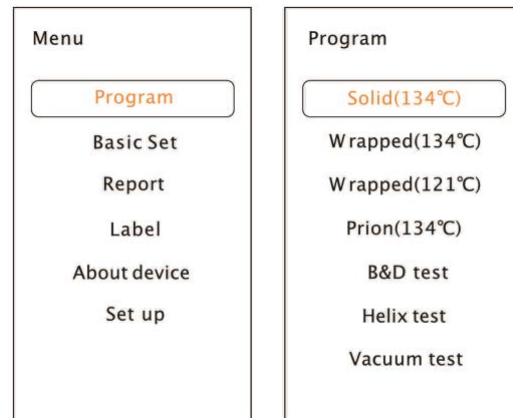

Start the sterilization program

Press  to start the cycle. The stage, conditions and the status of the cycle will appear on the display. The sterilizers will perform the program automatically. (see appendix 2).

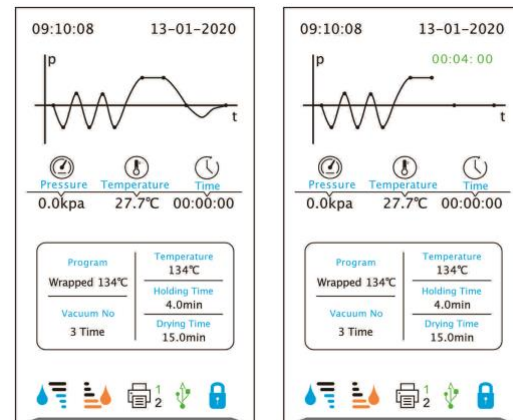

End of the cycle

Once the cycle is completed, "End" will appear at the end of the graphic, the printer will print out and the digital report saved in the USB memory is these are connected.



Caution: Always use the tray handle to load or unload the tray into the sterilizer. Failure to do so can result in burning.

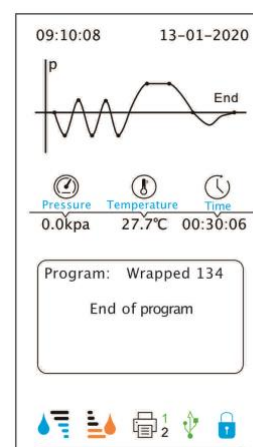

Manually interruption of the cycle

To interrupt a started cycle prematurely, hold  for 3 seconds.

If the cycle is manually interrupted after it reaches the drying phase, the items inside the sterilizer may be considered sterile and considering that the cycle has been interrupted during the drying phase the materials and instruments inside the chamber may be wet.

Note: If the cycle is manually interrupted before it reaches the drying phase, the items inside the sterilizer must be considered not sterile. N20 will appear on the screen. (see Error code description).



Caution: Depending on the phase of the cycle, steam and water can escape from the sterilization chamber when you open the door.

If the cycle is manually interrupted after it reaches the drying phase, the items inside the sterilizer may be considered sterile.

Note: Considering that the cycle has been interrupted during the drying phase the materials and instruments inside the chamber may be wet.

If the cycle is manually interrupted before it reaches the drying phase, the items inside the sterilizer must be considered not sterile.



Caution: Depending on the phase of the cycle, steam and water can escape from the sterilization chamber when you open the door.

Delay start cycle

Select "Delay start". Select the program by pressing \uparrow/\downarrow then press m to confirm. Select the parameter by pressing m button. Adjust it by pressing \uparrow/\downarrow . Press m button to save and back.

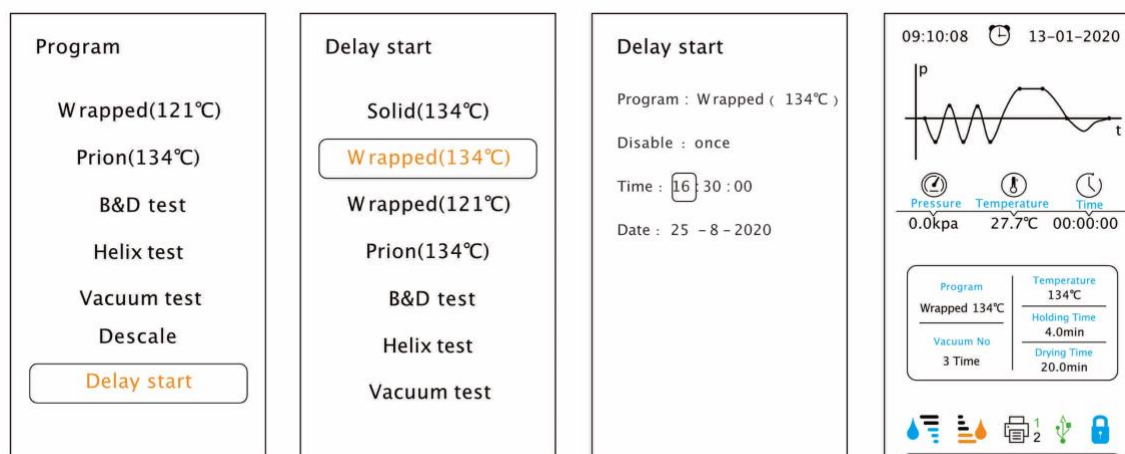

Test Programs

Helix Test

Put the Helix test device into the chamber, then close the door. Select "Program" from the main menu by pressing \uparrow/\downarrow then m to enter in the menu, select "Helix test"; in the screen will appear the information as temperature and sterilization time (holding time), also the date, time, current pressure and current temperature.

Press m to start the cycle. The stage, conditions and the status of the cycle will appear on the display. The sterilizers will perform the program automatically. (see appendix 2).

After finishing the cycle, you may check the indicator and evaluate the result according with the instructions of the test manufacturer.

B&D test

Put the B&D test package into the chamber, then close the door. Select "Program" from the main menu by pressing \uparrow/\downarrow then m to enter in the menu, select B&D test, in the screen will appear the information as the temperature and sterilization time (holding time), also the date, time, current pressure and current temperature.

Press m to start the cycle. The stage, conditions and the status of the cycle will appear on the display. The sterilizers will perform the program automatically. (see appendix 2).

After finishing the cycle, you may check the indicator and evaluate the result according with the instructions of the test manufacturer.

Vacuum Test

Select “Program” from the main menu by pressing \uparrow / \downarrow then m to enter in the menu, select “Vacuum test”.

After closing the door, press start to start the cycle. The stage, conditions and the status of the cycle will appear on the display. The sterilizers will perform the program automatically. (see appendix 2).

In compliance with EN 13060, the test requires that the air leakage rate less than or equal to 0.13 kPa/min during 10 minutes.

If leakage rate is not greater 0.13, it will show Success.

If the temperature difference between the max. Temperature and the Min. is above 3°C, it will show void. That means the result of the test is fail. You need run the vacuum test again after the chamber has cooled down.

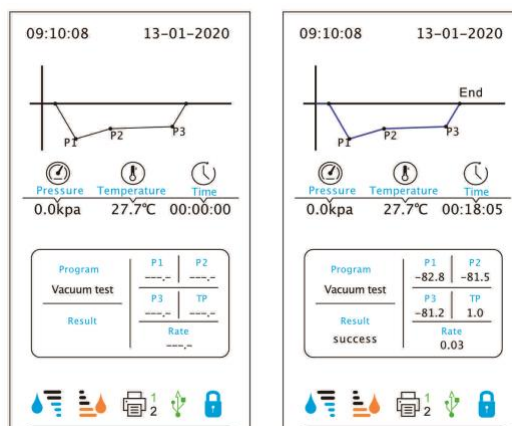

Descale

Mix the descaling powder with distilled water to make descaler according with the instruction of the descaling powder manufacturer.

From the Programs menu select descale.

After closing the door, press start to start the cycle. The stage, conditions and the status of the cycle will appear on the display. The sterilizers will perform the program automatically. (see appendix 2).

Follow the instructions in the screen.

Remove all instruments inside the chamber and close the door.

Empty the freshwater tank and fill with descaler which prepared as above, to 2/3 of the water tank.

Press start , start descaling, it will take around 25 minutes.

After descaling, empty the freshwater tank and fill with distilled water.

Press start , start flushing, it will take around 8 minutes.

After flushing, the cycle “Descale” is end.

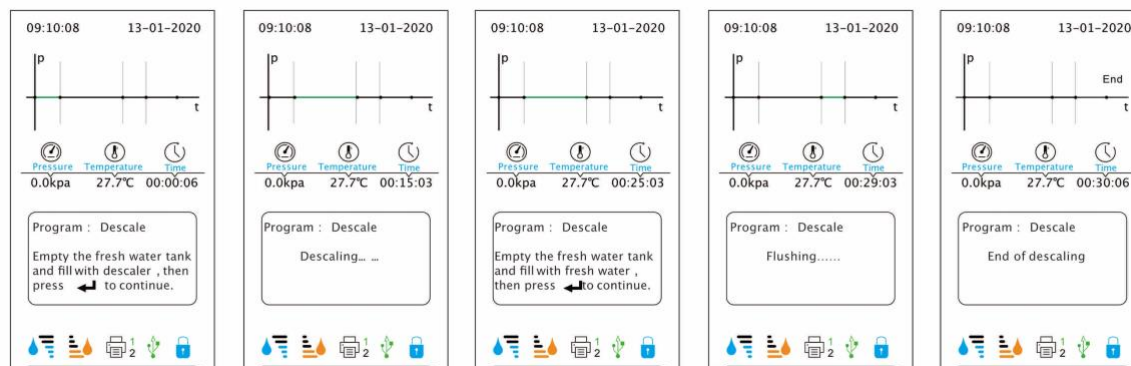

Data

The internal memory will store the information of the last 9999 cycles.

Print report (Optional)

Internal Memory

In this menu you can get the information of all the cycles stored in the internal memory of the sterilizer.

Select "Report" from the main menu and press  button, you will see the list of records.

Select the record by pressing  button.

Press  button to print and save the report.

Press  button to exit.

E.g.

If the serial number of the steam sterilizer is E00001 and the cycle number is 0012.

The file name of the file will be 01001200.log

The first two numbers represent machine number.

The middle four numbers represent cycle number.

The last two numbers represent error code.

00: no error; 01: error E01

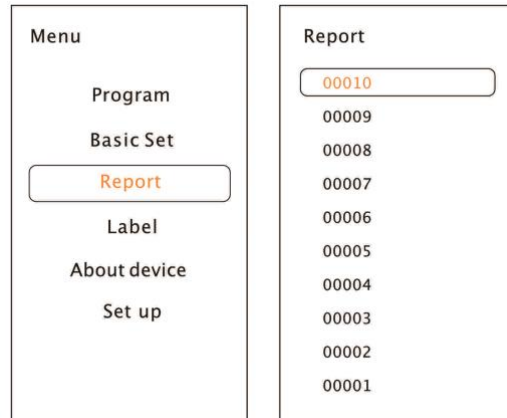

Sample of a printer report

```
=====
==
Program: WRAPPED
Temperature: 134C
Pressure: 206.0 kPa
Drying Time: 08Min
Holding Time: 4.0Min
-----
      Time  Temp.  Pressure
Start 12:28:17 089.0C
T1:   12:31:32 087.1C -075.0kPa
T2:   12:33:43 110.2C 052.0kPa
T3:   12:36:37 088.9C -075.0kPa
T4:   12:39:20 114.7C 053.7kPa
T5:   12:43:37 087.9C -075.0kPa
T6:   12:50:40 134.8C 206.0kPa
TS:           134.7C 209.5kPa
Max. Temperature:135.2C
Min. Temperature:134.3C
Max. Pressure:214.0kPa
Min. Pressure:204.9kPa
T7:   12:54:39 134.4C 211.4kPa
T8:   12:57:36 102.1C -060.0kPa
T9:   12:59:54 098.2C -060.0kPa
End   13:04:07 102.4C
-----
Cycle No.: 00017
Ster. Value: Success
Date: 2017-06-07
SN:E54723
Operator:
v 2B00V2.5
=====
==
```

Print labels (Optional)

Select "labels", it will show cycle numbers. Select the cycle number, press  button to print the labels.

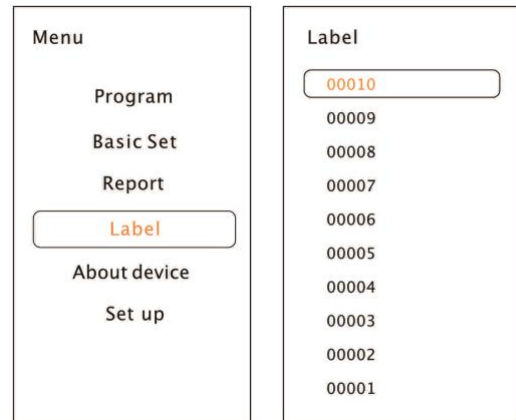

6 Maintenance

To ensure proper operation and maximum steam sterilizer life, carefully follow all recommendations for periodic maintenance.

One of the most important steps you can take to prevent problems with your sterilizer is to use only distilled water.

| Frequency | Number of cycles | Maintenance operation |
|----------------|------------------|---|
| Monthly | 50 | Clean the door seal |
| | | Clean the filter inside the chamber and in the clean water tank |
| | | Clean the chamber the trays and the rack |
| | | Clean the external surface |
| Every 3 months | 200 | Clean the distilled water tank |
| Every year | 800 | Replace the door seal |

Select Settings from the main menu and tap "Maintenance", to enter in the menu. Select the item to check the information.

Clean the distilled water tank

Disconnect the main cable.

Drain the tank completely using the drain connector at the back of the sterilizer and leave it connected into the connector in an open position.

Clean the internal surface with a soft sponge and a small soft brush for the areas difficult to reach using and a distilled water.

Remove the filter and clean it with a small soft brush and mild soap, rinse it with distilled water, and put it back in to the position.

Replacement of the bacteriological filter.

The bacteriological filter is in the back of the sterilizer. Unscrew the filter by hand anti-clockwise.

Place the new bacteriological filter.

Screw the new filter by hand clockwise.

Note: Do not operate sterilizer without filters in place.

Clean chamber, door seal ring, trays, and tray rack.

Remove the trays and tray rack from the chamber.

Clean trays, rack and inside of the chamber with mild soap.

Rinse the trays, rack and inside of the chamber with a smooth cloth and distilled water.

Examine door seal for possible damage.

Clean door seal and mating surfaces with a damp cloth.

Note: Do not use bleaching agents or any abrasive materials or substances in the chamber.

Failure to comply may cause damage to the chamber and/or other components.



Caution: To prevent burns, let the unit cool before cleaning gaskets and touch the surface.

Door adjustment

Under normal circumstances, the chamber door does not require adjustments. However, if the seal fails (resulting in steam leaking from the front of the chamber), you may adjust it.

Open the door, insert your finger into the bottom of the door, and pull the ring to unlock the mechanism. Turn the lid counterclockwise to tighten it. If it is too tight, you may also turn the lid clockwise to loosen it.

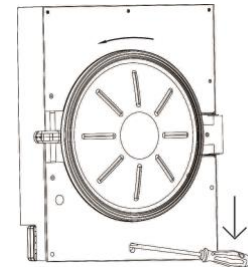

Replacement of the door seal ring

Open the chamber door. Remove the door seal ring carefully by hand.

Clean the door seal ring carefully with a smooth cloth with distilled water.

Moisten the new seal with distilled water.

Insert the new seal and tap in sequence as follows:

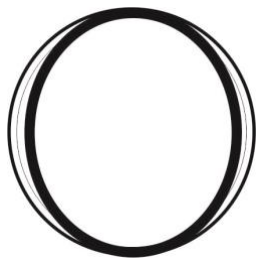

Press in the top and bottom of the door seal.

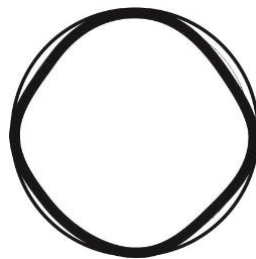

Press in the left and right sides of the door seal.

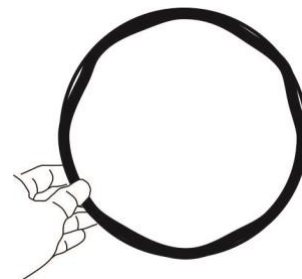

Press the remaining sections of the seal.



Caution: Please ensure the chamber and the door are cold prior to replacing the seal ring.

The drain valves

To drain the water from the used water tank or to fill the tank from an external container, insert the connector attached to the silicone tube until a click is heard. To disconnect the connector, press the metal button.

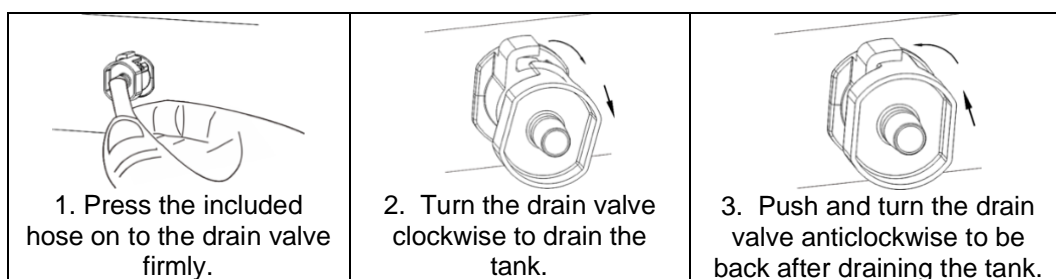

7 Troubleshooting

| Code | Description | Proposed solution |
|------|---|---|
| E1 | Steam generator temperature sensor error. | Power off & run a new cycle Contact your supplier if error persists. |
| E2 | Inner temperature sensor error. | Power off & run a new cycle Contact your supplier if error persists. |
| E3 | Temperature sensor of the chamber wall error. | Carefully ensure that the chamber wall is heated and contact your supplier. |
| E5 | Fail to release the pressure. | Power off & run a new cycle Contact your supplier if error persists. |
| E6 | Door lock problem during the cycle. | Make sure you had closed the door properly. check the door switch. |
| E7 | Error between temperature and pressure correlation. | Power off & run a new cycle Contact your supplier if error persists. |
| E8 | Error between temperature and pressure correlation. | Power off & run a new cycle Contact your supplier if error persists. |
| E9 | Failure to hold temperature. | Ensure the distilled tank isn't empty. Check the inner temperature sensor. Check somewhere for leaking. |
| E10 | The door locking system doesn't work. | The electromagnet of locking system doesn't work. The switch of locking system doesn't work. |
| E11 | Failure to preheat the steam generator. | Power off & run a new cycle Contact your supplier if error persists. |
| E12 | Failure to preheat the chamber. | Power off & run a new cycle Contact your supplier if error persists. |
| E13 | Vacuum failed. | Power off & run a new cycle Contact your supplier if error persists. |
| E15 | Inner temperature sensor error #2* | Power off & run a new cycle Contact your supplier if error persists. |
| E16 | Pressure error | Replace the air filter Power off & run a new cycle Contact your supplier if error persists. |
| N20 | Program manually interrupted | Reset the error from main screen. |
| E22 | Vacuum test failure | Somewhere is leaking. Check the door seal. Or contact your supplier if error persists. |
| N23 | Result of vacuum test is void | The temperature of the chamber is high. Try again after the chamber has cooled down. |
| E24 | It takes too long time to enter the next status. | Check somewhere leaking. Or contact your supplier if error persists. |
| N27 | The vacuum test fails. | Switch off. Then switch on after the chamber cool down and try again. |

| | | |
|-----|------------------------------------|---|
| E28 | The pressure is overload. | Power off and contact your supplier if error persists. |
| E30 | Vacuum failed. | Power off & run a new cycle Contact your supplier if error persists. |
| E31 | Inner temperature sensor error #2* | Power off & run a new cycle Contact your supplier if error persists. |

8 Transportation and storage

Switch off the sterilizer before transportation or storage.
Pull out the plug. Let the machine cool down.
Drain the distilled water tank and the used water tank.

Conditions for transport and storage

Temperature: -20°C ~ +50°C

Relative humidity: ≤ 85%

Atmospheric pressure: 50kPa~ 106kPa.

9 Safety devices

1. Main breaker: Protection of the instrument against possible failures of the heating resistor.

Action: Interruption of the electric power supply.

2. Thermal cutouts on the main transformer winding: protection against possible short circuit and main transformer primary winding overheating

Action: Temporary interruption of winding.

3. Safety valve: Protection against possible sterilization chamber over-pressure.

Action: Release of the steam and restoration of the safety pressure.

4. Safety micro-switch for the door status: Comparison for the correct closing position of the door.

Action: Signal of the wrong position of the door

5. Thermostat on chamber heating resistors: Protection for possible overheating of the chamber heating resistors.

Action: Interruption of the power supply of the chamber resistors.

6. Thermostat on steam generator heating resistors: Protection for possible overheating of the steam generator heating resistors.

Action: Interruption of the power supply of the steam generator resistors.

7. Door safety lock: Protection against accidental opening of the door.

Action: Impediment of the accidental opening if the door during the program.

8. Self-leveling hydraulic system: Hydraulic system for the natural pressure leveling in case of manual cycle interruption, alarm or blackout.

Action: Automatic restoration of the atmospheric pressure inside the chamber.

Appendix 1

Water properties / Characteristics

| Description | Feed water | Condensate |
|----------------------|------------------|------------------|
| Evaporate residue | ≤ 10mg/ l | ≤ 1.0mg/kg |
| Silicium oxide sio2 | ≤ 1mg/ l | ≤ 1.0mg/kg |
| Iron | ≤ 0.2mg/ l | ≤ 0.1mg/kg |
| Cadmiun | ≤ 0.005mg/ l | ≤ 0.05mg/kg |
| Lead | ≤ 0.05mg/ l | ≤ 0.1mg/kg |
| Rest of heavy metals | ≤ 0.1mg/ l | ≤ 0.1mg/kg |
| Chloride | ≤ 2mg/ l | ≤ 0.1mg/kg |
| Phosphates | ≤ 0.5 mg/ l | ≤ 0.1mg/kg |
| Conductivity | ≤ 15µs /cm | ≤ 3 µs /cm |
| PH Value | 5 – 7.5 | 5-7 |
| Appearance | Colorless, clean | Colorless, clean |
| Hardness | 0.02 mmol/ l | 0.02 mmol/ l |

Diagrams of the sterilization programs STE-18-D Pro

| Programs | Temperature (°C) | Pressure (kPa) | Holding time | Total time (min) | Type | Max load (kg) | Max load per tray (kg) |
|-------------------|------------------|----------------|--------------|------------------|---|---------------|------------------------|
| Solid 134 | 134 | 210 | 3.5 | 12-30 | Unwrapped solid material | 4.50 | 1.20 |
| Wrapped 134 | 134 | 210 | 4 | 30-49 | Unwrapped solid material | 4.50 | 1.20 |
| | | | | | Single-wrapped solid or hollow material | 4.00 | 1.10 |
| Wrapped 121 | 121 | 110 | 20 | 38~54 | Unwrapped solid material | 4.50 | 1.20 |
| | | | | | Single-wrapped solid or hollow material | 4.00 | 1.10 |
| Prion 134 | 134 | 210 | 18 | 37-52 | Unwrapped porous material | 1.00 | 0.30 |
| | | | | | Single-wrapped porous material | 0.80 | 0.25 |
| | | | | | Dual-wrapped porous material | 0.60 | 0.20 |
| | | | | | Single-wrapped hollow material | 3.50 | 1.00 |
| | | | | | Dual-wrapped solid and hollow material | 1.50 | 0.50 |
| Drying (optional) | — | — | — | 1-20 | — | — | — |
| B&D test | 134 | 210 | 3.5 | 28-35 | — | — | — |
| Helix test | 134 | 210 | 3.5 | 28-35 | — | — | — |
| Vacuum test | — | — | — | 20-25 | — | — | — |

The time required for sterilizer to be ready for routine use after the power is switched is less than 5 minutes.

The max. Temperature of the 134°C sterilization cycle is 137°C

The max. Temperature of the 121°C sterilization cycle is 124°C

Appendix 3

Diagrams of the sterilization programs STE-23-D Pro

| Programs | Temperature (°C) | Pressure (kPa) | Holding time | Total time (min) | Type | Max load (kg) | Max load per tray (kg) |
|-------------------|------------------|----------------|--------------|------------------|---|---------------|------------------------|
| Solid 134 | 134 | 210 | 4 | 15-30 | Unwrapped solid material | 5.00 | 1.50 |
| Wrapped 134 | 134 | 210 | 4 | 38-57 | Unwrapped solid material | 5.00 | 1.50 |
| | | | | | Single-wrapped solid or hollow material | 4.50 | 1.20 |
| Wrapped 121 | 121 | 110 | 20 | 46~62 | Unwrapped solid material | 5.00 | 1.50 |
| | | | | | Single-wrapped solid or hollow material | 4.50 | 1.20 |
| Prion134 | 134 | 210 | 18 | 45-60 | Unwrapped porous material | 1.25 | 0.40 |
| | | | | | Single-wrapped porous material | 1.10 | 0.30 |
| | | | | | Dual-wrapped porous material | 0.75 | 0.25 |
| | | | | | Single-wrapped hollow material | 4.00 | 1.25 |
| | | | | | Dual-wrapped solid and hollow material | 2.00 | 0.60 |
| Drying (optional) | — | — | — | 1-20 | — | — | — |
| B&D test | 134 | 210 | 3.5 | 28-35 | — | — | — |
| Helix test | 134 | 210 | 3.5 | 28-35 | — | — | — |
| Vacuum test | — | — | — | 20-25 | — | — | — |

The time required for sterilizer to be ready for routine use after the power is switched is less than 5 minutes.

The max. Temperature of the 134°C sterilization cycle is 137°C

The max. Temperature of the 121°C sterilization cycle is 124°C