

Light efficiency:

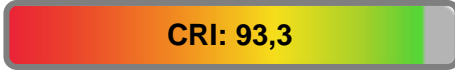

Light quality:



Color temperature:

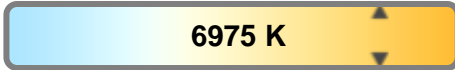

**Output: 10322 lm**

**Peak: 7048 cd**

**Power: 157 W**

**PF: 0,97**



Product name:

**Brite Triton**

Item number:

**Brite Triton**

Date and time:

**19-06-2018 14:59:09**

Description:

**The Brite Triton consists of 3 panels with a strip of LED's beneath.**

**The Brite Triton was measured in 8 different planes to take into account for any possible stray light.**

**The 8 planes are sufficient for interpolating between point and give a very accurate result.**

**The measurement was done with the highest possible light setting on the lamp.**

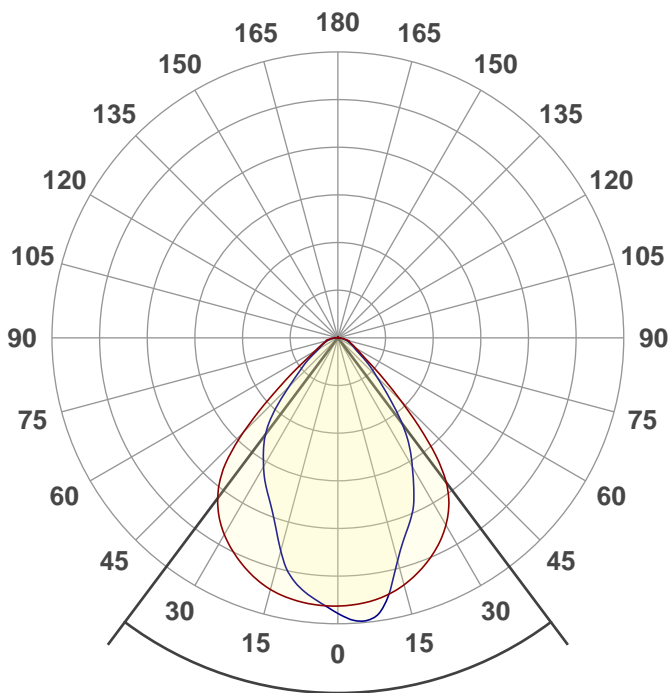

Beam angle **73,7°**



CIE 1931  
x: 0,307  
y: 0,316

Spectra

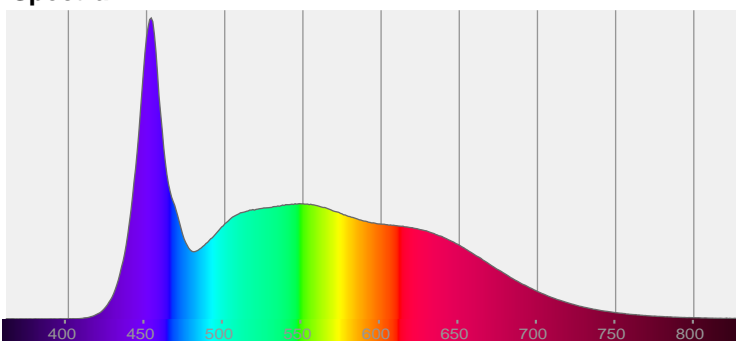

Power

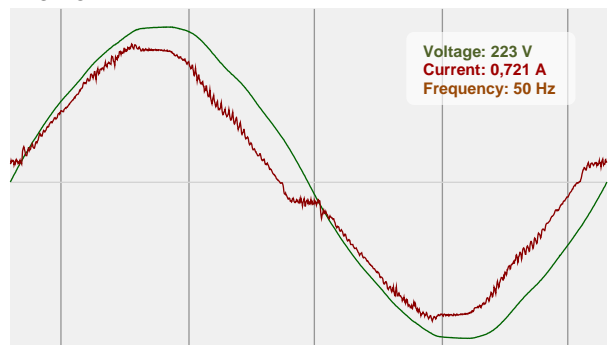

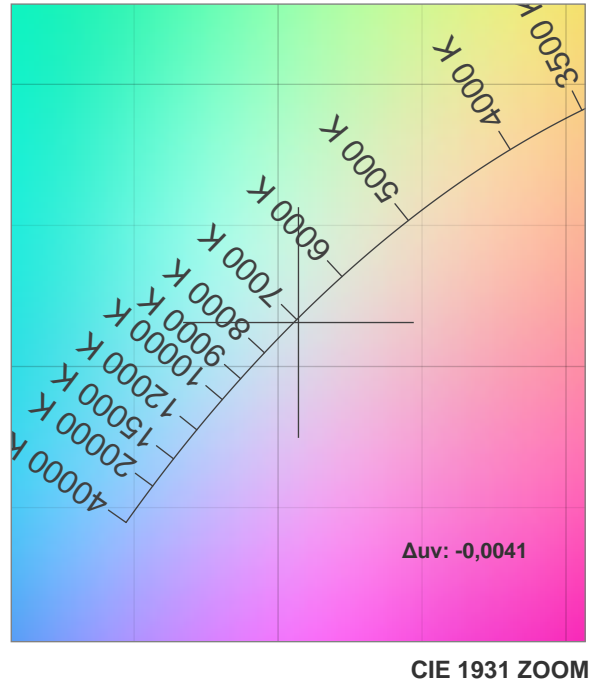
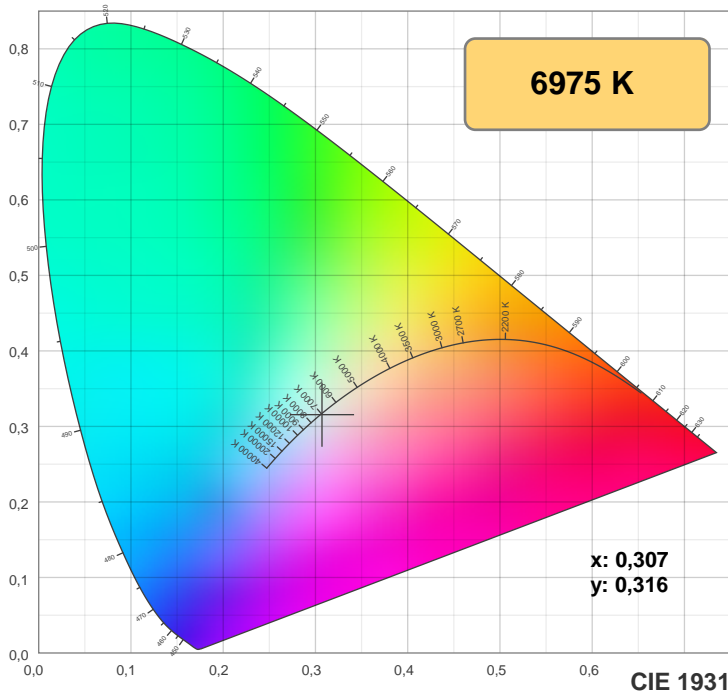

**TM30: 87,6**

**CRI: 93,3 (R1-R8)**

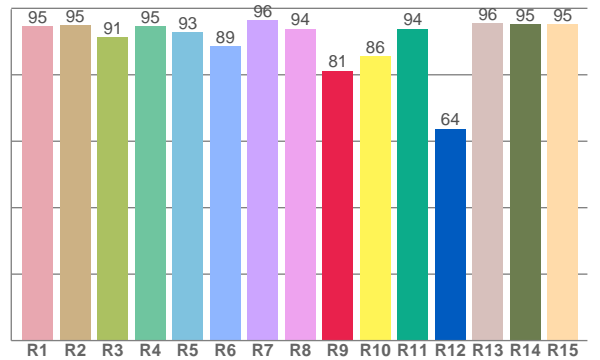
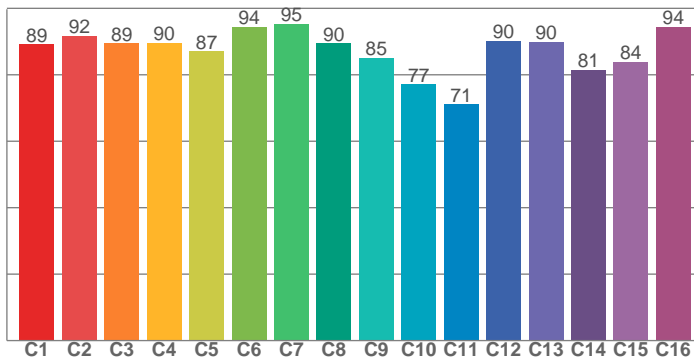

**CRI R values, only R1-R8 are used to calculate final CRI value**

R1	R2	R3	R4	R5	R6	R7	R8	R9	R10	R11	R12	R13	R14	R15
94,5	94,9	91,2	94,6	92,8	88,5	96,3	93,8	81,2	85,6	93,8	63,8	95,6	95,2	95,2

**TM30 C values, 16 binned values out of total of 99 C values**

C1	C2	C3	C4	C5	C6	C7	C8	C9	C10	C11	C12	C13	C14	C15	C16
89,1	91,8	89,5	89,6	87,0	94,4	95,4	89,5	85,1	77,1	71,2	90,3	90,0	81,5	83,9	94,4

**CQS Q values**

Q1	Q2	Q3	Q4	Q5	Q6	Q7	Q8	Q9	Q10	Q11	Q12	Q13	Q14	Q15
94,6	98,3	80,4	77,1	85,3	90,4	93,9	96,5	94,6	90,5	88,3	89,6	91,7	92,7	93,9

**CQS: 89,0**

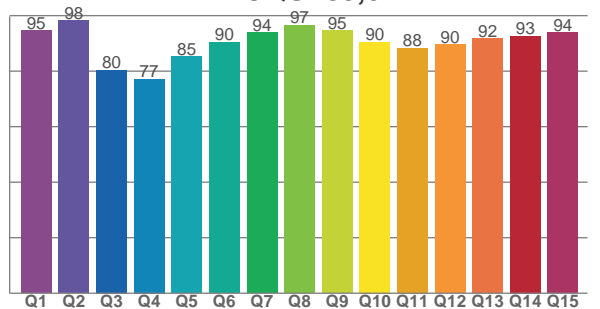

**Color parameters**

Color temperature	Color rendering index	Red component	Color fidelity	Color gamut	Color quality scale	Color coordinate cie 1931	Color coordinate cie 1931	Color coordinate	Color coordinate	Color deviation from black body
CCT	CRI	CRI R9	TM30 Rf	TM30 Rg	CQS	x	y	u	v	Δuv
6975 K	93,3	81,2	87,6	99,5	89,0	0,307	0,316	0,199	0,307	-0,0041

**Rf 87,6**  
Fidelity index Rf

**Rg 99,5**  
Gammut index Rg

Hue Bin	R <sub>f</sub>	Graphic shifts (%)	
		Chroma	Hue
1	89	-4%	0%
2	92	-2%	3%
3	89	-1%	4%
4	90	0%	4%
5	87	-3%	1%
6	94	0%	0%
7	95	-3%	0%
8	90	-4%	3%
9	85	-6%	10%
10	77	-2%	15%
11	71	3%	13%
12	90	3%	4%
13	90	8%	2%
14	81	14%	-4%
15	84	6%	-9%
16	94	-1%	-2%

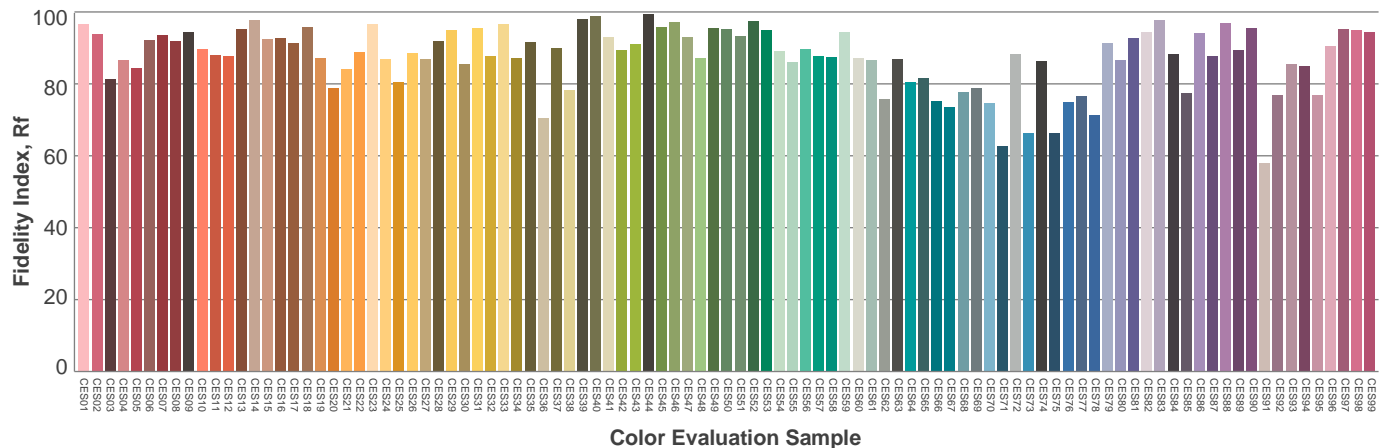
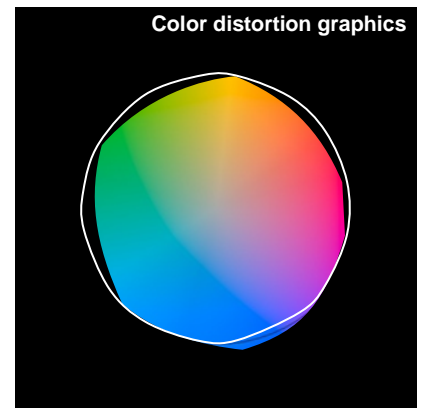
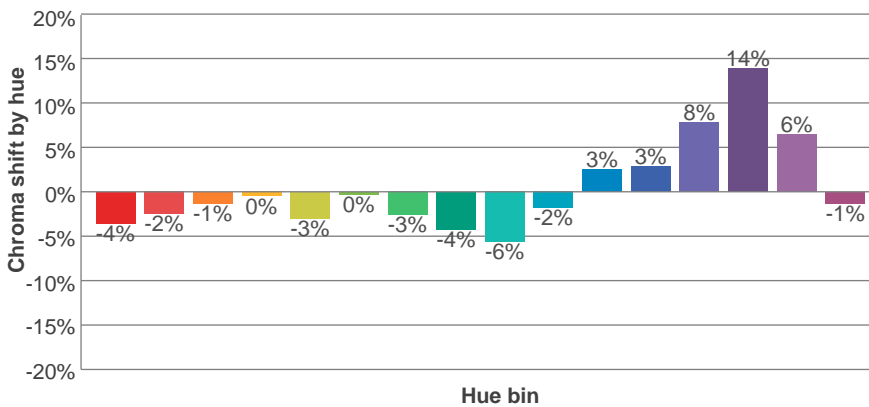
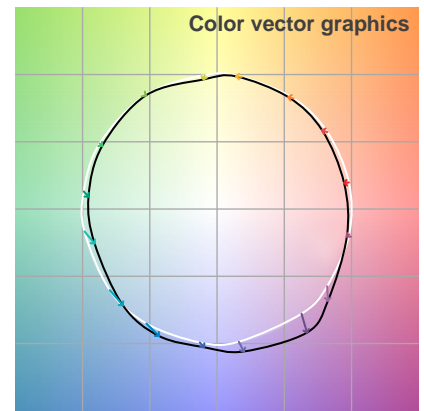
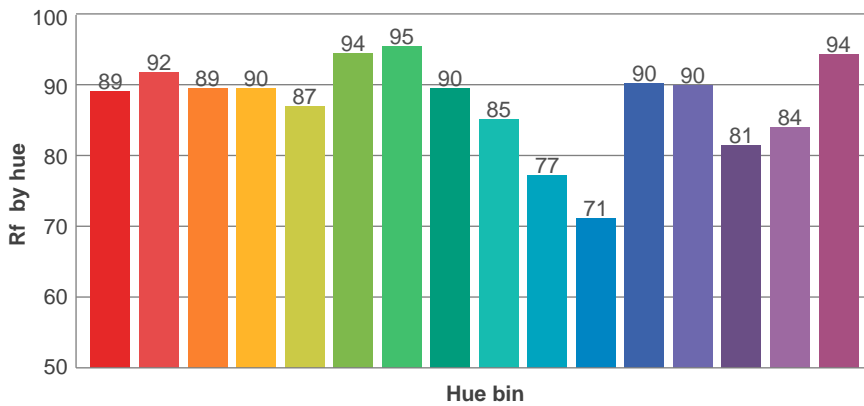
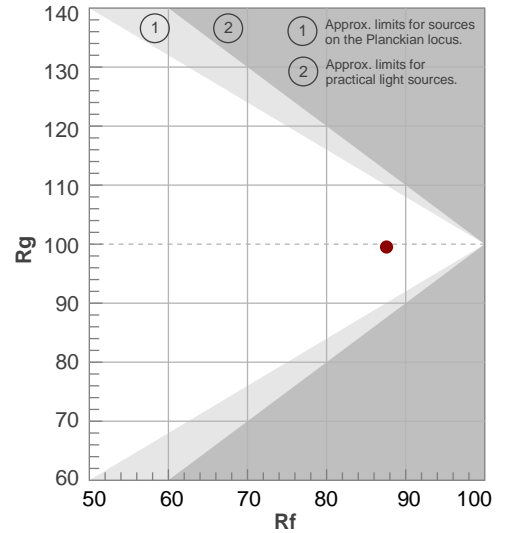

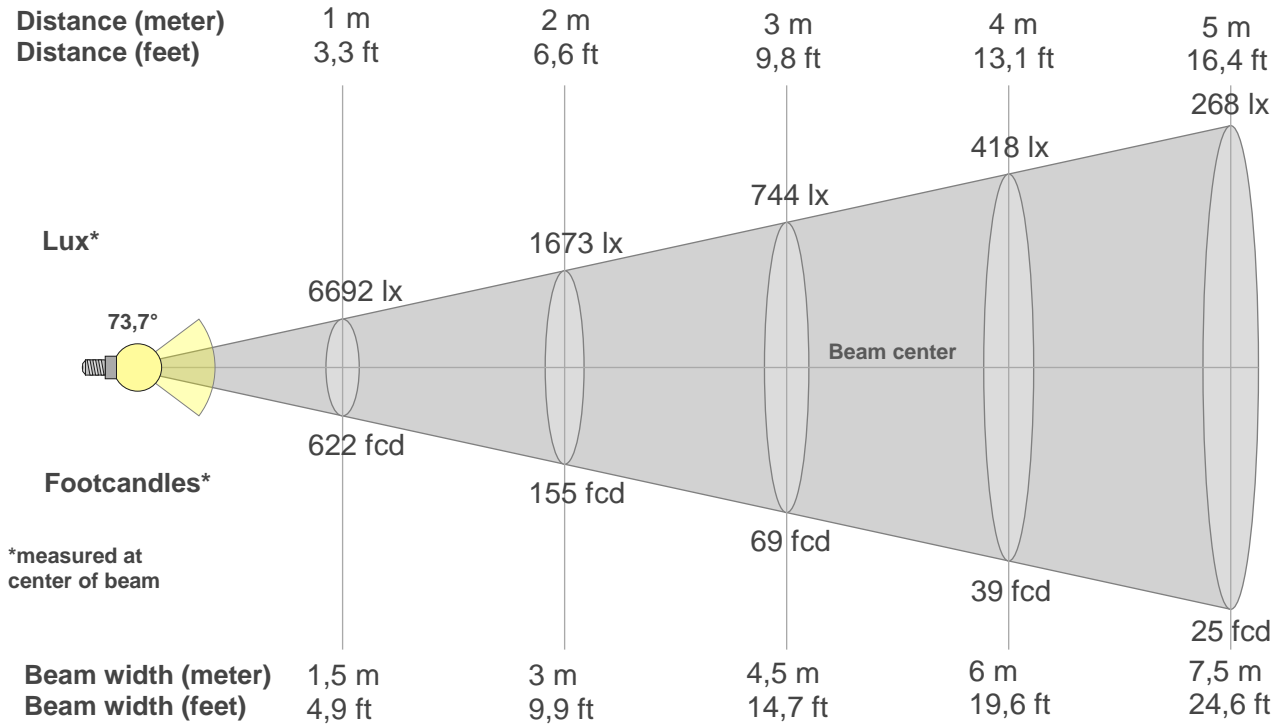

**Beam intensities from 1-20m**

1m	2m	3m	4m	5m	6m	7m	8m	9m	10m	11m	12m	13m	14m	15m	16m	17m	18m	19m	20m
3,3ft	6,6ft	9,8ft	13,1ft	16,4ft	19,7ft	23ft	26,2ft	29,5ft	32,8ft	36,1ft	39,4ft	42,7ft	45,9ft	49,2ft	52,5ft	55,8ft	59,1ft	62,3ft	65,6ft
6692lx	1673lx	744lx	418lx	268lx	186lx	137lx	105lx	83lx	67lx	55lx	46lx	40lx	34lx	30lx	26lx	23lx	21lx	19lx	17lx
621,7fcd	155,4fcd	69,1fcd	38,9fcd	24,9fcd	17,3fcd	12,7fcd	9,7fcd	7,7fcd	6,2fcd	5,1fcd	4,3fcd	3,7fcd	3,2fcd	2,8fcd	2,4fcd	2,2fcd	1,9fcd	1,7fcd	1,6fcd

**Intensities in 0° c-plane**

0°	5°	10°	15°	20°	25°	30°	35°	40°	45°	50°	55°	60°	65°	70°	75°	80°	85°	90°	95°
6692	6613	6516	6339	6085	5767	5356	4777	3735	2229	1226	732	526	401	314	276	167	74	7	3
100%	99%	97%	95%	91%	86%	80%	71%	56%	33%	18%	11%	8%	6%	5%	4%	2%	1%	0%	0%

**Intensities in 90° c-plane**

0°	5°	10°	15°	20°	25°	30°	35°	40°	45°	50°	55°	60°	65°	70°	75°	80°	85°	90°	95°
6692	7038	6683	5739	5048	4453	3695	2974	2069	1373	942	600	450	350	268	188	99	24	2	1
100%	105%	100%	86%	75%	67%	55%	44%	31%	21%	14%	9%	7%	5%	4%	3%	1%	0%	0%	0%

**Intensities in 180° c-plane**

0°	5°	10°	15°	20°	25°	30°	35°	40°	45°	50°	55°	60°	65°	70°	75°	80°	85°	90°	95°
6692	6642	6580	6460	6251	5972	5630	5175	4504	3313	1882	1027	661	487	374	306	245	148	38	2
100%	99%	98%	97%	93%	89%	84%	77%	67%	50%	28%	15%	10%	7%	6%	5%	4%	2%	1%	0%

**Intensities in 270° c-plane**

0°	5°	10°	15°	20°	25°	30°	35°	40°	45°	50°	55°	60°	65°	70°	75°	80°	85°	90°	95°
6692	6509	6148	5470	4693	4167	3686	3190	2555	1729	1173	808	544	435	343	264	177	86	13	1
100%	97%	92%	82%	70%	62%	55%	48%	38%	26%	18%	12%	8%	6%	5%	4%	3%	1%	0%	0%

Beam angle 50%	Field angle 10%	Cutoff angle 2,5%	Intensity ratio in 120° cone	Intensity ratio in 90° cone
<b>73,7°</b>	<b>114,6°</b>	<b>159,6°</b>	<b>91,9%</b>	<b>77,5%</b>

**ISO candela diagram**

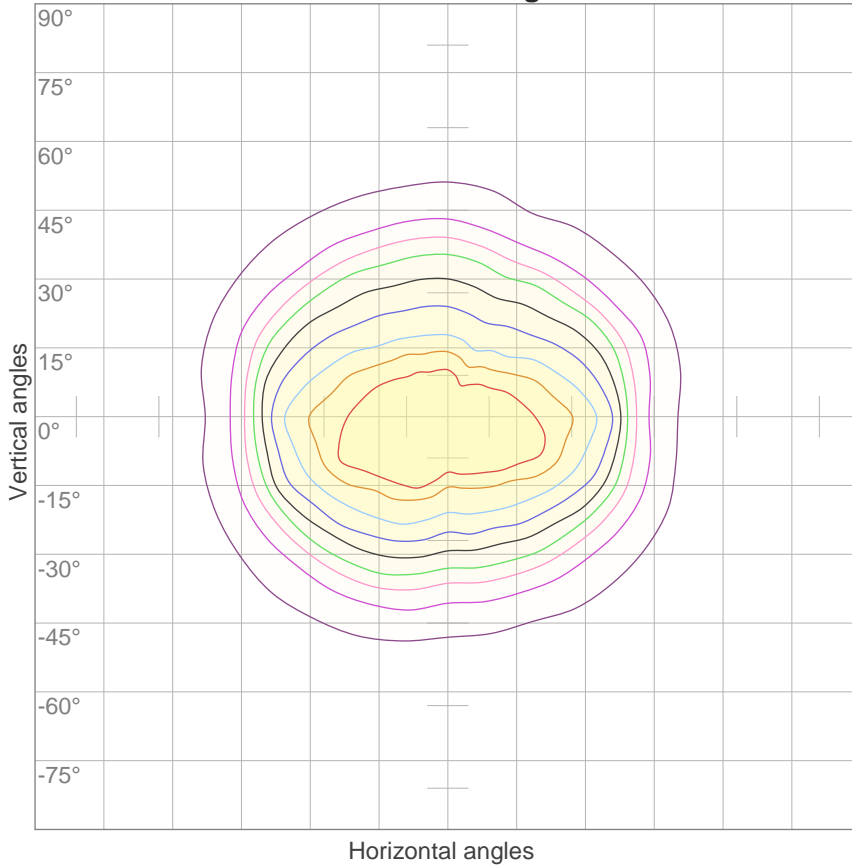

10%	669 cd
20%	1338 cd
30%	2008 cd
40%	2677 cd
50%	3346 cd
60%	4015 cd
70%	4684 cd
80%	5354 cd
90%	6023 cd

Conditions:

Number of c-planes: 16

Candela at center: 6692 cd

**ISO lux diagram**

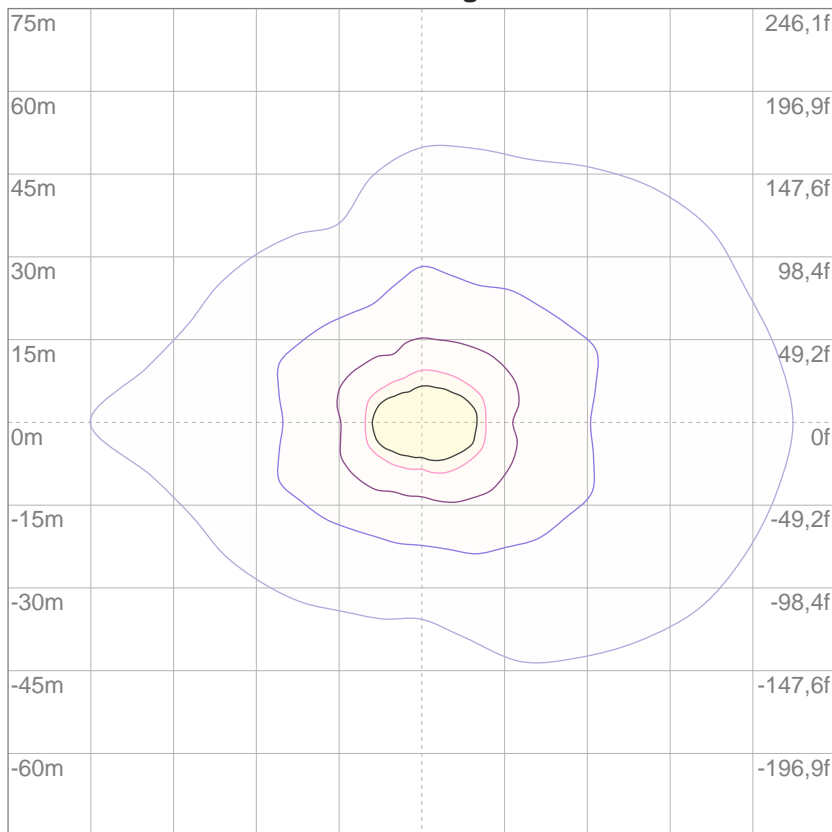

3%	2,01 lx
5%	3,35 lx
10%	6,69 lx
30%	20,1 lx
50%	33,5 lx

Conditions:

Number of c-planes: 16

Lux at center: 66,9 lx

*Lux distribution on a surface when lamp is mounted at 10 meters from the surface.*

Mounting height: 10 meters (33 feet)

**Glare Evaluation According to UGR**

p Ceiling		70	70	50	50	30	70	70	50	50	30
p Walls		50	30	50	30	30	50	30	50	30	30
p Floor		20	20	20	20	20	20	20	20	20	20
Room size X    Y		Viewing direction at right angles to lamp axis					Viewing direction parallel to lamp axis				
2H	2H	19,0	20,0	19,2	20,2	20,4	17,7	18,7	18,0	18,9	19,2
	3H	19,4	20,3	19,7	20,5	20,8	18,2	19,1	18,5	19,3	19,6
	4H	19,7	20,5	20,0	20,8	21,1	18,4	19,3	18,8	19,6	19,8
	6H	20,0	20,8	20,3	21,1	21,4	18,6	19,4	19,0	19,7	20,0
	8H	20,1	20,8	20,5	21,2	21,5	18,7	19,4	19,0	19,7	20,0
	12H	20,2	20,9	20,5	21,2	21,5	18,7	19,4	19,0	19,7	20,0
4H	2H	19,0	19,9	19,3	20,1	20,4	18,0	18,9	18,4	19,1	19,4
	3H	19,7	20,4	20,0	20,7	21,0	18,7	19,4	19,1	19,7	20,1
	4H	20,1	20,7	20,5	21,1	21,4	19,1	19,7	19,5	20,1	20,4
	6H	20,5	21,1	20,9	21,4	21,8	19,4	19,9	19,8	20,3	20,7
	8H	20,7	21,2	21,1	21,6	22,0	19,5	20,0	19,9	20,4	20,8
	12H	20,8	21,3	21,3	21,7	22,1	19,5	20,0	20,0	20,4	20,8
8H	4H	20,2	20,7	20,7	21,1	21,5	19,4	19,8	19,8	20,2	20,6
	6H	20,7	21,1	21,2	21,6	22,0	19,8	20,2	20,3	20,6	21,1
	8H	21,0	21,3	21,5	21,8	22,3	20,0	20,3	20,5	20,8	21,3
	12H	21,1	21,4	21,6	21,9	22,4	20,1	20,4	20,6	20,8	21,3
12H	4H	20,2	20,6	20,7	21,1	21,5	19,4	19,8	19,8	20,2	20,7
	6H	20,8	21,1	21,2	21,6	22,0	19,9	20,2	20,4	20,7	21,2
	8H	21,0	21,3	21,5	21,8	22,3	20,1	20,4	20,6	20,9	21,4
Variation of the observer position for the luminaire distance S											
S = 1,0H		+0,6 / -1,0					+0,9 / -0,9				
S = 1,5H		+1,9 / -1,5					+1,3 / -1,3				
S = 2,0H		+3,3 / -2,0					+2,2 / -1,6				
Standard table		BK03					BK03				
Correction summand		2,9					2,0				
Corrected glare indices referring to 10322 lm total luminous flux											

UGR data could be incorrect as lamp output is not symmetrical. Goto Edit->Photometric->Corrections and select Correct asymmetry.

## Coefficients of Utilization

Ceiling reflectance	80				70				50			30			10			0	
Wall reflectance	70	50	30	10	70	50	30	10	50	30	10	50	30	10	50	30	10	0	
Floor reflectance	20	20	20	20	20	20	20	20	20	20	20	20	20	20	20	20	20	20	0
RCR	(RCR: Room Cavity Ratio)																		
	Room Values are expressed as percentage of Lumens delivered to the task surface																		
0	119	119	119	119	116	116	116	116	111	111	111	106	106	106	102	102	102	100	
1	111	108	104	101	109	105	102	100	101	99	96	97	95	93	94	92	91	89	
2	104	97	92	87	101	95	90	86	92	88	84	89	85	82	86	83	81	79	
3	97	88	82	76	94	87	81	76	84	79	74	81	77	73	79	75	72	70	
4	90	80	73	68	88	79	72	67	77	71	66	74	69	65	72	68	65	63	
5	84	73	66	61	82	72	65	60	70	64	60	68	63	59	67	62	58	57	
6	79	67	60	55	77	67	59	54	65	59	54	63	58	53	62	57	53	51	
7	74	62	55	50	72	61	54	49	60	54	49	59	53	49	57	52	48	47	
8	69	58	50	45	68	57	50	45	56	49	45	54	49	45	53	48	44	43	
9	65	54	46	42	64	53	46	41	52	46	41	51	45	41	50	45	41	39	
10	62	50	43	38	60	49	43	38	48	42	38	48	42	38	47	42	38	36	

LAMPS (number of lamps)

## Luminaire budgetary diagram

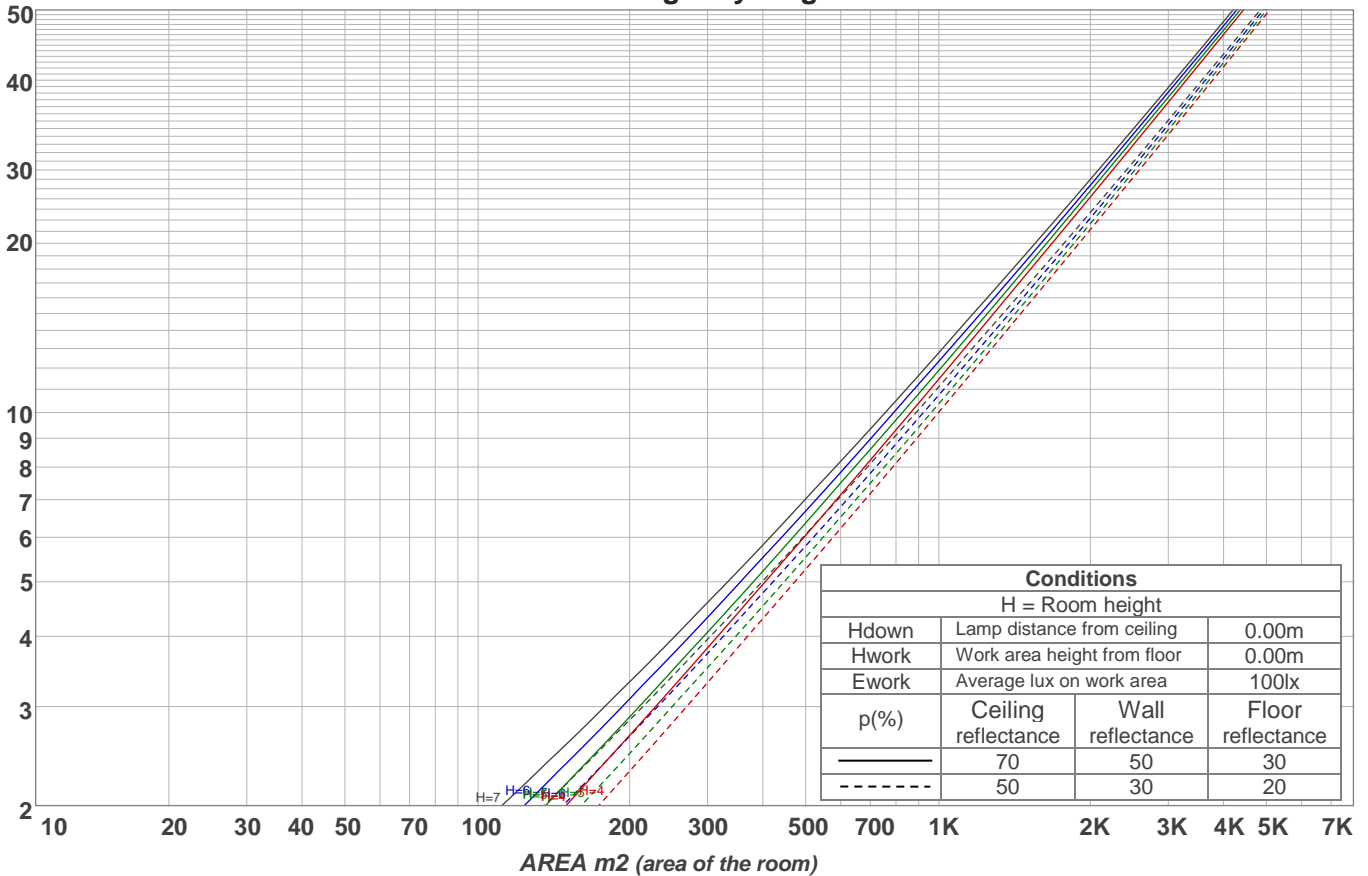

## Zonal Lumen Summary

0°-10°	10°-20°	20°-30°	30°-40°	40°-50°	50°-60°	60°-70°	70°-80°	80°-90°
633 lm	1710 lm	2306 lm	2380 lm	1661 lm	800 lm	434 lm	267 lm	89,3 lm
90°-100°	100°-110°	110°-120°	120°-130°	130°-140°	140°-150°	150°-160°	160°-170°	170°-180°
3,38 lm	2,94 lm	4,23 lm	5,65 lm	6,53 lm	6,74 lm	5,89 lm	4,08 lm	1,46 lm

**Warmup curve**

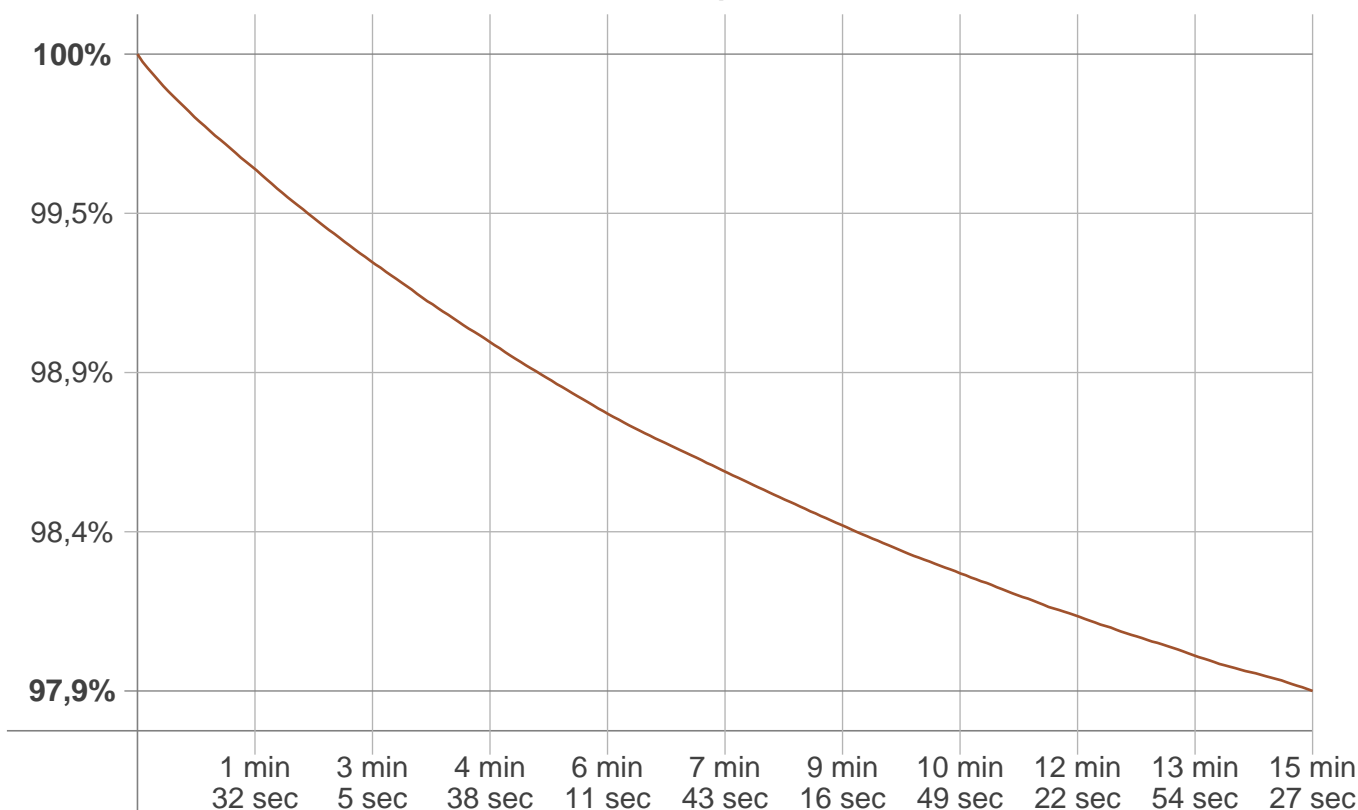

**Warmup result**

<b>Warmup time:</b>	<b>15 min 27 sec</b>
<b>Warmup variation</b>	<b>-2,1%</b>

**Warmup conditions**

<b>Stable period:</b>	<b>15 min</b>
<b>Stable change max:</b>	<b>2,0%</b>
<b>Minimum time:</b>	<b>15 min</b>

**Color temperature change**

CCT start	CCT change	CCT end
6927 K	+48 K	6975 K

**Output change**

Output start	Output change	Output end
10536 lm	-214 lm	10322 lm



**Flicker curve (complete sampled flicker signal)**



**Flicker frame (frame of one flicker period)**

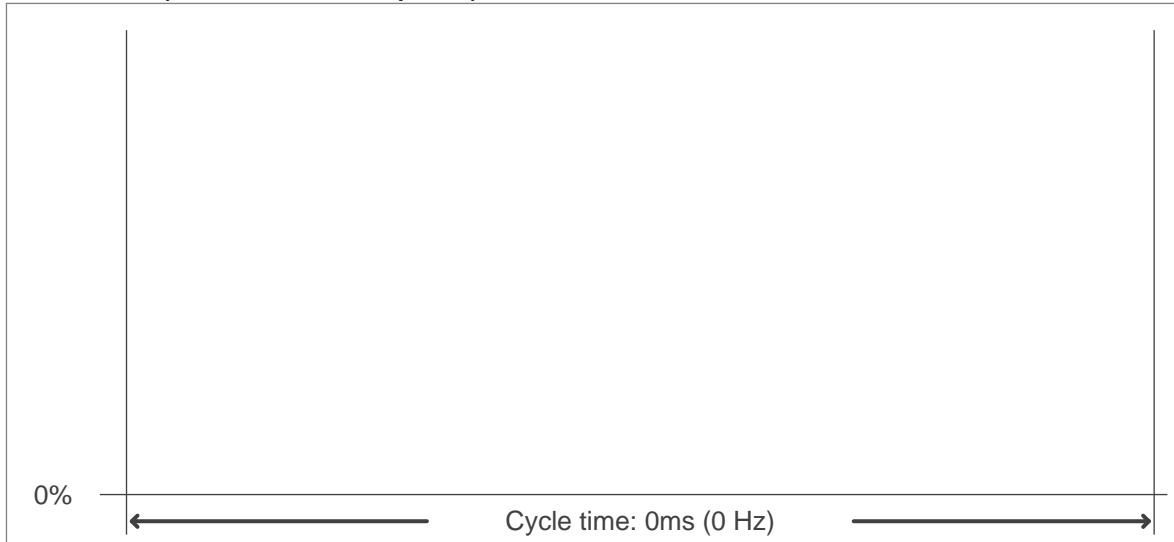

**Flicker FFT (frequency scope of flicker curve)**

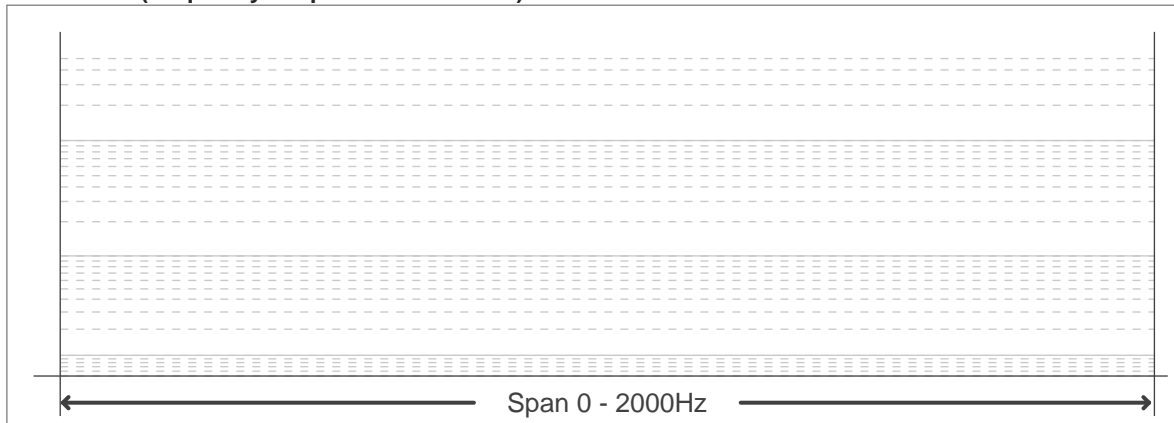

**Flicker results:**

<b>Flicker frequency:</b>	<b>n/a Hz</b>
<b>Flicker index:</b>	<b>n/a</b>
<b>Flicker percentage:</b>	<b>n/a %</b>
<b>SVM: (Visual flicker)</b>	<b>n/a</b>

**Flicker conditions:**

<b>Sample rate:</b>	<b>60.000 samples/second</b>
---------------------	------------------------------