

# Art.03002 rev.001 TOTAL POSTURE

# Art.03003 rev.001 TOTAL POSTURE WALL

Apparecchiatura di supporto per l'analisi posturale  
Support Device for postural analysis

## MANUALE D'USO E MANUTENZIONE USER AND MAINTENANCE MANUAL

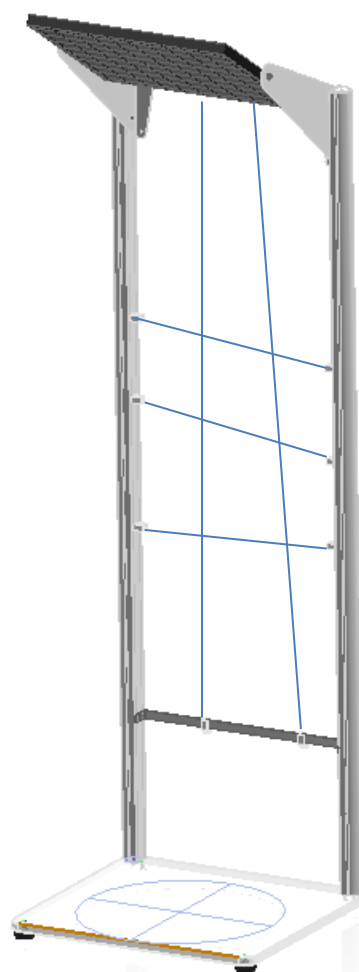

CE



Art.:03002



Art.:03003

**ENGLISH VERSION..... 4**

**1 GENERAL INFORMATION ..... 4**

1.1 PURPOSE, CONTENT AND RECIPIENTS OF THESE INSTRUCTIONS ..... 4

1.2 MANUFACTURER..... 4

1.3 INTENDED USE AND EQUIPMENT DESCRIPTION ..... 4

**1.4 PRODUCT DETAILS ..... 4**

1.5 STORAGE ..... 4

1.6 SYMBOLS ..... 4

**2 SPECIAL WARNINGS AND USE RESTRICTIONS ..... 5**

2.1 SIDE EFFECTS AND CONTRAINDICATIONS ..... 5

**3 USE..... 6**

3.1 STANDARD FITTINGS ..... 6

3.2 MAJOR COMPONENTS ..... 6

3.3 SETTING UP, SETTING AND STARTING UP ..... 6

3.4 USE WITHOUT SOFTWARE OR WEBCAM..... 8

3.5 USE WITH SOFTWARE AND WEBCAM SYSTEM ..... 9

3.6 TRANSPORTING THE EQUIPMENT..... 9

**4 MAINTENANCE ..... 10**

4.1 PERIODIC MAINTENANCE ..... 10

4.2 SPARE PARTS..... 10

**5 TROUBLESHOOTING ..... 10**

**6 CARING FOR THE FRAME AND CLEANING ..... 11**

6.1 WASHING ..... 11

6.2 DISINFECTION..... 11

**7 TECHNICAL DATA AND PRINCIPAL DIMENSIONS ..... 12**

**8 RELATED ITEMS ..... 12**

8.1 DESK ..... 12

8.2 TOTAL POSTURE + PHYSICAL ANALYZER..... 12

**9 WARRANTY ..... 13**

**10 DISPOSAL OF ELECTRICAL OR ELECTRONIC EQUIPMENT AND PACKAGING ..... 13**

**11 MAINTENANCE RECORD SHEET..... 14**

# ENGLISH VERSION

## 1 GENERAL INFORMATION

### 1.1 Purpose, content and recipients of these instructions

The purpose of this manual is to provide the information required to permit proper use of the equipment, and make it possible to use it independently and safely.

This Manual contains information on technical, operation, and maintenance aspects, as well as on spare parts and safety issues.

It is also intended for technicians responsible for providing maintenance of the equipment.

This Instruction Manual must always be kept with the equipment and must be carefully preserved in order to avoid compromising its readability.

If sold to third parties this manual has to be handed over with the other documents as required by European Directive 93/42 EEC

### 1.2 Manufacturer

CHINESPORT S.P.A, Via Croazia, 2-33100 Udine Italy

tel. +39 0432621621–fax+39 0432621620 – website: [www.chinesport.it](http://www.chinesport.it)

The company has a quality system that complies with the UNI EN ISO 13485:2012 standard.

### 1.3 Intended use and equipment description

This is a device intended for posture analysis with a mirror for an overhead view. It allows to detect the variances of points of repere by means of a dedicated software and webcam or by means of lines and scaled ruler.

### 1.4 Product details

Further documentation can be found on our website [www.chinesport.it](http://www.chinesport.it)

In particular, you can connect to the website quickly by reading the QR code on the cover of this manual. It is easy to access the site by reading the QR Code printed on the cover of this catalog. Sometimes the QR Code can also be found on the product itself.

The declaration of conformity and other details, even in a full-color version, are available at the “online product data sheet” section of the website, in a more updated version when possible.





In order to understand the instruction manual better, see chapter 3 USE

### 1.5 Storage

The following conditions must be ensured when the equipment is to be stored:  
relative humidity 25% - 85%; temperature 5°C - +70°C - clean environment

### 1.6 Symbols

The symbols found in this manual and on the equipment itself are used to draw the user’s attention to important safety warnings and useful information. Observe all warning, caution and danger messages.

	<b>WARNING</b> This symbol identifies operating/maintenance instructions or procedures which, if not observed, could result in injury or danger to the user.
	<b>ELECTRIC SHOCK HAZARD</b> This symbol identifies operating/maintenance instructions or procedures which, if not observed, could result in a risk of electric shock.
	<b>CAUTION</b> This symbol is used to warn the user that failure to observe certain operating or maintenance procedures, general rules or conditions, could result in damage to the equipment.
	<b>NOTE</b> Notes draw the user's attention to important information on topics, applications or procedures.
	<b>SUGGESTION</b> Suggestions draw the user's attention to the quickest and simplest way to complete an activity.

## 2 SPECIAL WARNINGS AND USE RESTRICTIONS

This equipment is designed and built exclusively for carrying out the functions described in this instruction manual.

- **This equipment must not be used:**
  - When its use is contraindicated or may cause discomfort to the patient.
  - For people that weigh more than 200 kg.
  - On unstable and/or uneven surfaces (e.g. stairways, steps, etc.).
  - If the original product has been modified or tampered with.
  - In an explosive and/or corrosive atmosphere, or exposed to severe weather conditions.
  - With improper configuration or when it may be harmful for the patient.
- If used by aged persons or people with limited balance, we recommend taking special care.
-  The material of which the basis is made may have some minor imperfection, striation, and/or microscopic dots on the surface, but these do not affect the equipment's functionality.
- Plastic parts of the equipment can catch fire if brought into contact with naked flames.
- Be sure the patient does not trip over while getting on or off the equipment.
- Make sure the patient is capable of self-balance.
- Two persons needed when moving the equipment around.
- Never spill any liquids on the equipment.

### 2.1 Side effects and contraindications

There are no particular side effects when this equipment is used correctly, provided this instruction manual has been studied.

The equipment is not recommended for people with significant balance problems.

## 3 USE

### 3.1 Standard fittings

The equipment is delivered, packaged to protect it against any impacts that may occur while in transit.

The pack contains:

- The platform
- Two aluminum side bars
- Mirror clamp
- Mirror
- Bag with screws
- Plumb line
- This Instructions Manual.

### 3.2 Major components

- 1) Grill-patterned revolving mirror
- 2) Adjusting screws for the mirror
- 3) Mirror clamp
- 4) Aluminum side bars
- 5) Reference thread lines (accessory)
- 6) Reference thread lines support (accessory)
- 7) Plumb line
- 8) Platform
- 9) Adjustable support feet

#### 10) Included tools:

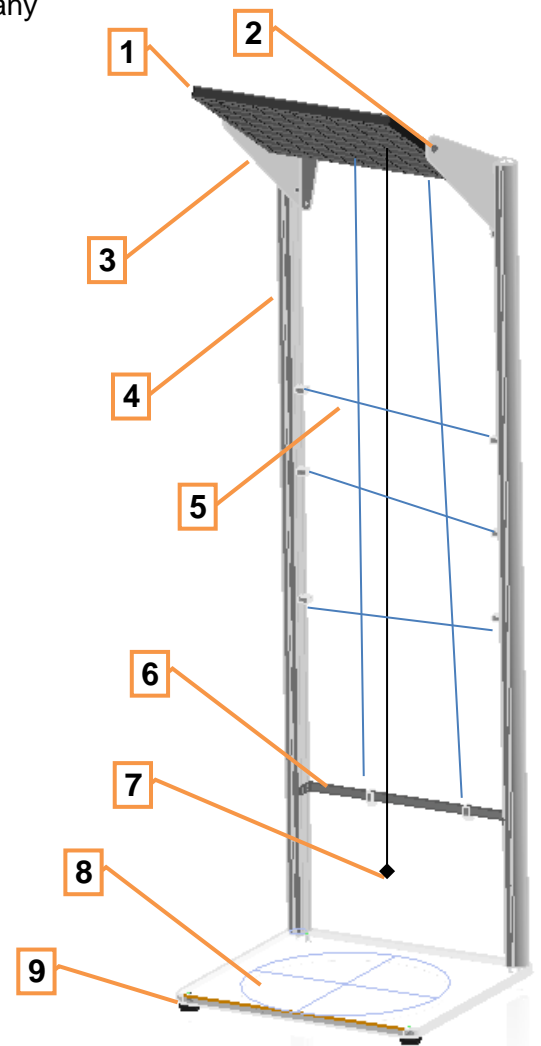
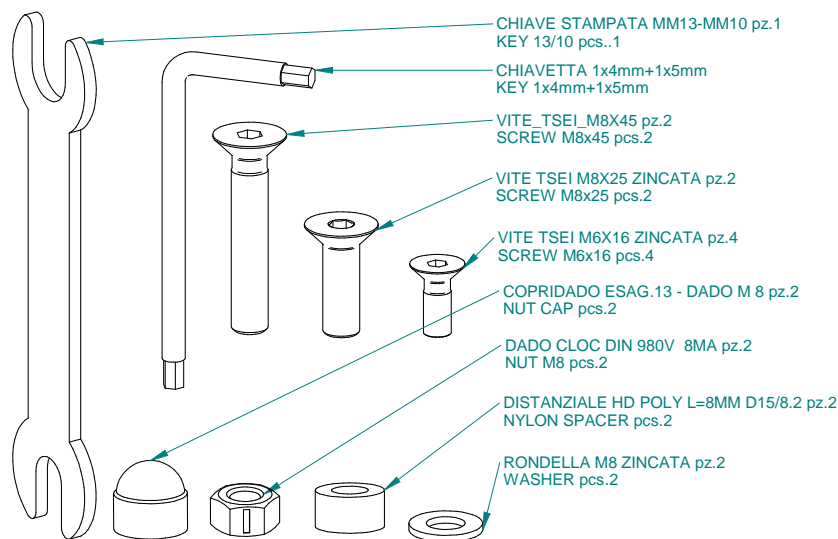

### 3.3 Setting up, setting and starting up

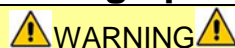

Before using the equipment make sure it is stable. The equipment must be positioned away from stairs, sloping floors, etc.

When dealing with patients with balance problems, be particularly careful and support them.

### 3.3.1 Setting up and assembly of the base.

1. Take the equipment out of its packing
2. Position the equipment in an easily accessible place, so that the patient's safety can be guaranteed. Check that the area the equipment is positioned in makes it easy for the patient to get on and off.
3. Fix the aluminum bars onto the platform using the screws included
4. Screw onto the platform the 6 supporting leg and put the rubber pieces on.

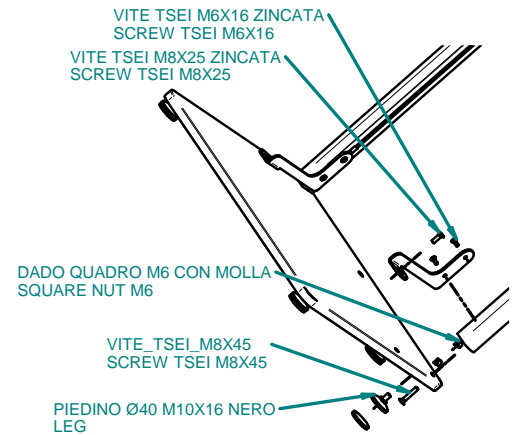

### 3.3.2 Setting up and assembly of the wall clamp (03003 only)

It is used for fixing the wall clamp for holding the mirror. Use the anchors included only with brick walls or reinforced concrete, have the job done by a professional.

### 3.3.3 Setting up and assembly of the mirror.

1. Enlarge mirror clamp and insert the mirror, interpose plastic shims and the washers. Tighten nuts to allow friction without blocking it completely.
2. Apply nuts cap.
3. Find and apply on the bars the square bolts to fix the mirror clamps using the screws included.
4. Put on the caps for covering the bars.
5. Fix the plumb line to the mirror support clamp

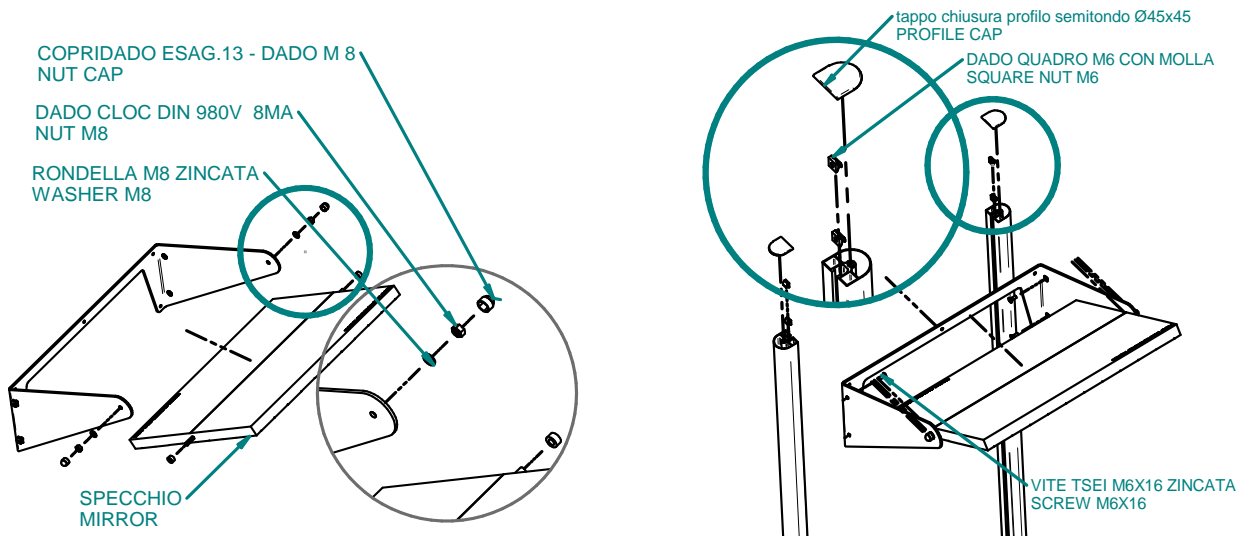

**⚠ WARNING ⚠**

Do not hang from the support clamp.  
Do not lean on the aluminum bars.  
If the mirror rotates too easily and is not moving by friction you must tighten the screws until friction is achieved.

### 3.3.4 Assembly of the reference line kit and clamp

The kit includes:

- 2 M6x16 screws
  - 2 square bolts
  - 1 clamp
  - 4 short elastic lines + 2 long elastic lines fixed to the transparent blocks
1. Locate the slots along the aluminum bars for inserting the blocks and the square bolts and insert subsequently the blocks of the short lines and for last the square bolt.
  2. Fix the line support clamp to the frame by tightening the screws included with the square bolts, and place it at 400mm from the platform.
  3. Fix the long lines to the mirror support clamp and to the line support clamp.
  4. Attach the scaled stickers included onto the aluminum bars and onto the mirror and line support.

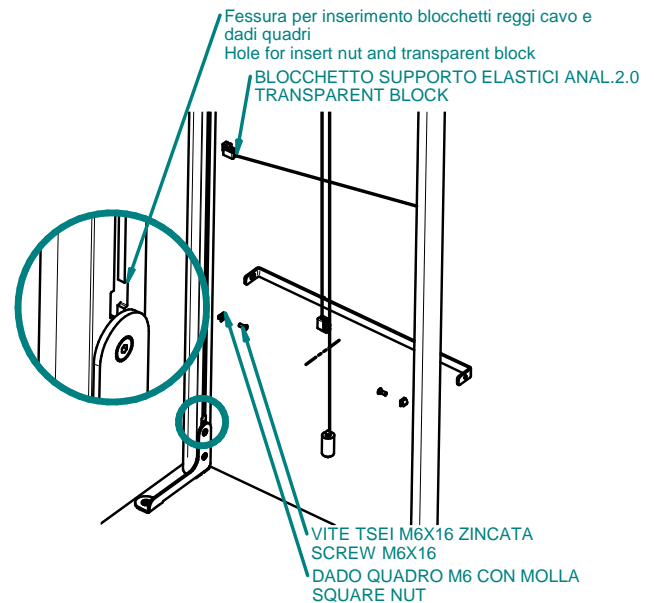

## 3.4 Use without software or webcam

The use without software or webcam is done for determining asymmetric points of repere at sight. To operate the equipment it must be set with the reference lines kit and clamp.

Place the patient on the platform in a way that the malleolus are on line with the reference cross printed on the base platform (the malleolus must be parallel to the transversal or to the longitudinal line considering if the patient is face front or backwards with the right side or left side out), the most accurate the position, the best results of the analysis are obtained.

The interested points of repere must be marked on the patient by using small adhesive discs or a dermographic pen.

At this point the operator must place himself in front of the support bars and look straight to the point of repere in question and change the position of the indicators of the elastic lines and write down on a sheet of a paper the corresponding values of height indicated in the scale.

Last, the operator moves away at a certain distance to look at the mirror which will show any eventual rotation/tumbling motion or backward/forward postures according to the position of the feet.

### 3.4.1 Examples of use

In order to obtain a good result it is necessary to follow some simple rules, so that major mistakes which invalidate the results of the analysis are avoided.

Get some round sticker of about 10-15mm in diameter.

Begin placing the stickers on the body of the patient.



Proceed in a way which may allow a subsequent analysis of the pathology subject of study.

It is possible to determine the points, as shown in the pictures, following one's own school and knowledge.

Once the points have been determined it is possible to transfer the patient onto the platform of the Support Device for postural analysis.





Have the patient move onto the support platform.

Do not force the patient to adopt an un-natural posture but rather let him or her put the feet in a comfortable and normal position. It is necessary to pay special attention to the position of the malleolus which must be aligned with the printed line.

After the patient is in position, the analysis of symmetries and/or asymmetries may start.

Special attention must be paid as to how the measurements are done. Measuring for a given patient must always be done by the same operator: in this way the method the method for obtaining the data is always the same reducing the possibility of mistakes.

Also, special attention must be paid when looking at the plumb lines considering the point of repere placed on the patient.

The eye of the operator must be at the same height of the point of repere to be considered: only in this way the parallax error is limited.

Therefore, the operator must bend the legs when the points of repere are located at a point lower than the eye level or climb on a support if the patient is taller than the operator.

Write down the value obtained in the patient's portfolio.

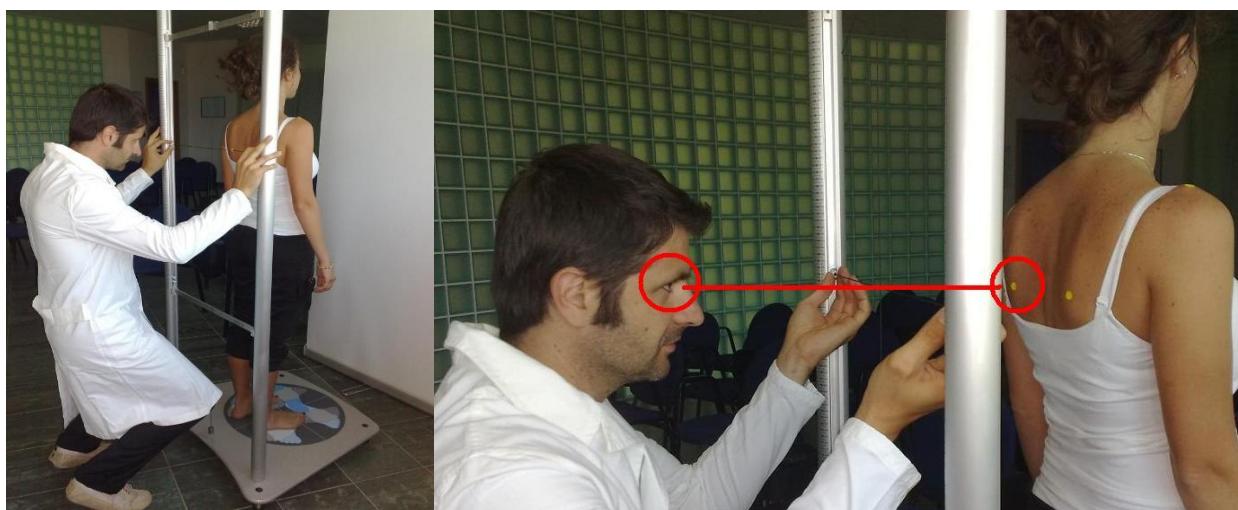

### 3.5 Use with software and webcam system

It is possible to implement along with the equipment the use of software operated cameras in order to avoid the manual measuring procedures, parallax errors and subjectivity of values.

The system allows the acquisition of pictures, check on asymmetries and measure leaning. It is also possible to overlap pictures the evolution of asymmetries and to create individual reports which can be viewed in PDF or printed.

Contact the CHINESPORT Commercial Department for any in-depth information or configuration of the product.

### 3.6 Transporting the equipment

The equipment can be transported by two persons by holding the platform for short distances. We recommend packing the equipment as it was when delivered, to prevent any damage while transferring.



## 4 MAINTENANCE

Maintenance operations are to be carried out by specialized technicians who are aware of the contents of this instruction manual.

Check that the equipment is safe after any "harsh treatment" (e.g. falling, harsh impacts, liquid spill, etc.) or whenever there may be any doubt about the safety of the equipment.

Refer to chapter 7 TECHNICAL DATA AND PRINCIPAL DIMENSIONS

### 4.1 Periodic maintenance

In order to keep the equipment in excellent safety and functionality conditions, check its mechanical soundness once a year.

**⚠ WARNING ⚠**

When safety is at risk, immediately turn off the equipment and do not use it until the danger has been eliminated.

Use the relevant form enclosed to record any defect/damage/action that is significant for the safety of the equipment.

FREQUENCY	OPERATION
Weekly	General cleaning of the equipment (for the support base, after every examination)
	Visual and functional inspection of the equipment and any accessories.
	Inspection to ensure the correct fastening of the mirror, which must be free to rotate with friction.

### 4.2 Spare parts

A spare parts list is supplied on request by Chinesport S.p.a. and also includes product order codes and price lists.

## 5 TROUBLESHOOTING

The equipment has undergone heavy-duty tests and no significant breaks and/or failures were reported. In case the equipment does not work, it is possible to open a service ticket via the customer service section of the [www.chinesport.com](http://www.chinesport.com) website.

**PLEASE NOTE:**

Before calling our customer service department, be sure to have your **SERIAL NUMBER** or "CODE and ARTICLE" at hand: you can find these on the product label located on the equipment (as shown in the image), or the delivery note/invoice number. This identification number helps reduce waiting times and improves service quality.

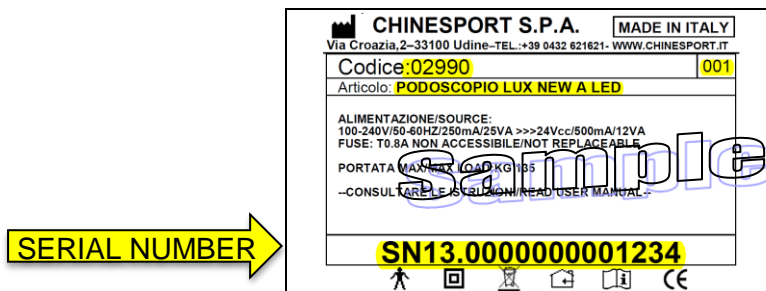

**NOTES:**

Equipment to be repaired on Chinesport's premises must bear the "AUTHORIZATION NUMBER" on the package. This identification number, which must be obtained from our Customer Service Department, helps reduce waiting times and improves service quality.

Alternatively, you can contact Customer Service by e-mail ([assistenza@chinesport.it](mailto:assistenza@chinesport.it)). Users without an internet connection can send a fax (0432 621 698) or phone (0432 621 699), but our response time could be longer.

## 6 CARING FOR THE FRAME AND CLEANING

The equipment's structure is and glass. Its strength and ease of maintenance make it particularly suitable for use in hospitals, old-age homes, etc.

Dust using a soft, damp cloth or chamois. Dry or abrasive cloths may cause scratches on the surface and create a static electricity charge on the surface.

### 6.1 Washing

Dust gently and in case of light stains pass a damp cloth or a neutral detergent over the surface. Let the fabric dry avoiding direct exposure to sunlight.

The glass top and mirror can be cleaned using normal glass cleaning products.

The following instructions are recommended for small local and more stubborn stains (oil, fat, cosmetics, ink, coffee, liquor, chewing-gum etc.): Dissolve the stain immediately using clear ethyl alcohol diluted in water at 20%, dab and then treat with a neutral detergent solution. Rinse well.

### 6.2 Disinfection

#### 6.2.1 Personal disinfection

The use of disinfectants such as AMUCHINA® 10% is recommended for the disinfection of hands or body parts that come in contact with the patient or surfaces. These should have the following activity spectrum:

Bactericidal activity in the presence of interfering substances according to EN 1276:1997 (1).

Fungicidal activity in the presence of interfering substances according to EN 1650:1997 (1).

Bactericidal activity on surfaces according to EN 13697:2001 (2).

Fungicidal activity on surfaces according to EN 13697:2001 (2).

Activity against Salmonella tiphymurium according to EN 13697:2001 (3).

Activity against HIV(4), HAV - HBV(5), HCV (6).

Virucidal activity according to EN14476:2005 (7).

Virucidal activity against influenza virus (H1N1) according to EN14476:2005 (8).

Read the package leaflet before use.

#### 6.2.2 Disinfection of surfaces

The use of AMUCHINA ALL-PURPOSE DISINFECTANT® is recommended for disinfecting the equipment, especially the sky upholstery, hand control, frame, and it should have the following activity spectrum:

Bactericidal activity in the presence of interfering substances according to EN 1276:1997 (1).

Fungicidal activity in the presence of interfering substances according to EN 1650:1997 (1).

Bactericidal activity on surfaces according to EN 13697:2001 (2).

Fungicidal activity on surfaces according to EN 13697:2001 (2).

Activity against Salmonella tiphymurium according to EN 13697:2001 (3).

Activity against HIV (4), HAV – HBV (5), HCV (6).

Virucidal activity according to EN14476:2005 (7).

Virucidal activity against influenza virus (H1N1) according to EN14476:2005 (8).

Read the package leaflet before use.

#### **WARNING**

- Use the equipment under hygienic conditions, and disinfect the surface in contact with the patient carefully.
- Aggressive products can damage surfaces.
- Before using the equipment check that all components are completely dry.
- **DO NOT USE:** Alcohol based products for cleaning glass, abrasive compounds, solvent such as acetone, benzene, alcohol, carbon tetrachloride, or similar products. These may scratch the surface, forming little cracks.

**7 TECHNICAL DATA AND PRINCIPAL DIMENSIONS**

<b>CHARACTERISTICS</b>	<b>Art cod.: 03002</b>
Weight empty	<b>Kg 20</b>
Maximum capacity	<b>Kg 200</b>

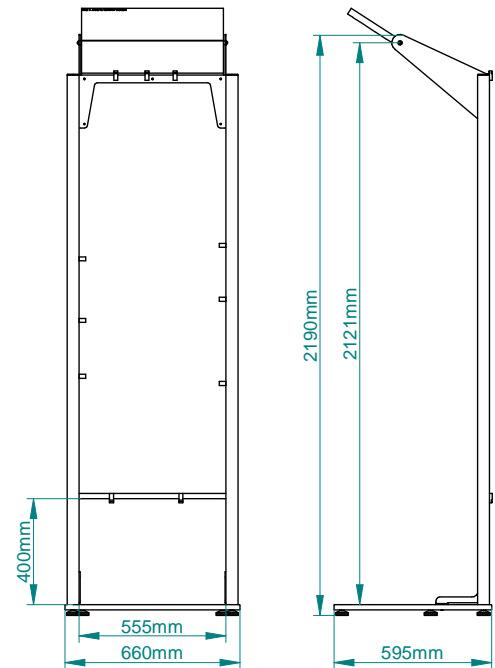

**8 RELATED ITEMS**

**8.1 Desk**

Desk for the computer, high (to be used while standing or with a high stool). It is made of transparent plastic material, with two extra shelves for fitting a printer or other accessories.

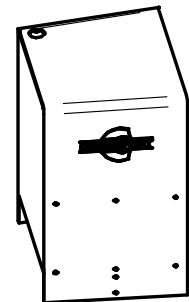

**8.2 TOTAL POSTURE + PHYSICAL ANALYZER**

It is a stand for fitting the software operated webcam for taking the pictures which of the person's posture, determine any eventual deviances and have the possibility, after subesequent visits to determine any improve or worsening of the posture.

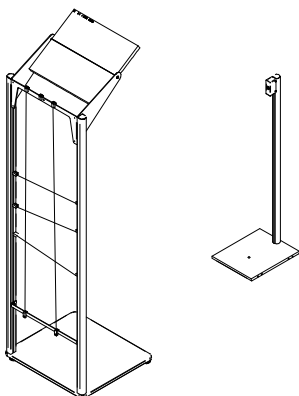

## 9 WARRANTY

### GENERAL AFTER-SALES SERVICE CONDITIONS FOR CHINESPORT ITEMS

The warranty shall be valid for a period of 24 months from the date of delivery.

The warranty does not cover consumable items, rechargeable batteries, and generally all materials subject to wear, breakdowns caused by knocks, falls, misuse or improper use, accidental events and damage while being transported. This warranty shall be automatically invalidated if the equipment is tampered with.

Repair of the equipment will be carried out in relation to the breakdown reported.

A quotation must be specifically requested.

Payment is cash on delivery, unless otherwise agreed.

Any dispute will be settled solely by the Court of UDINE.

### REPAIRS UNDER WARRANTY

Repairs under warranty must be specifically requested.

Repairs under warranty shall be carried out at our workshop and upon authorization, complete with the return authorization number.

Products are to be shipped in their original packaging, carriage paid.

A fiscal document (bill of sale, purchase invoice or cash receipt) is required to make a warranty claim; the purchase date indicated must fall within the warranty time period.

If the product is found to be in good working order without defect, the customer will be charged for the fault-finding service.

### REPAIRS NOT UNDER WARRANTY

For repairs not covered by the warranty carried out at our workshops upon authorization, transportation charges shall be paid by the customer.

The warranty on the parts replaced during repair operations is 12 months from the moment the equipment is collected.

If the product is found to be in good working order without defect, the customer shall be charged for the fault-finding service.

### REPAIRS DONE AT HOME

If repairs are done at the customer's home, a written request is required indicating the complete details of the person making the request, the type of machine and the breakdown.

The cost per kilometer for on-site technician visits will be agreed upon in relation to the customer's urgency.

If the machine is under warranty, the customer will have to pay only the expenses incurred for the technician to reach the customer's house.

Time is calculated from the moment the technician leaves our workshop until they return. The time of his/her return will be estimated based on the time required to get there.

### SALE OF SPARE PARTS AND CONSUMABLE ITEMS

Orders must be in writing and state the customer, the item and the shipping method as well as the customer's precise fiscal details.

The order processing time can vary depending on the availability of the material.

Returned spare parts will not be accepted.

Payment will be cash on delivery, unless otherwise agreed.

## 10 DISPOSAL OF ELECTRICAL OR ELECTRONIC EQUIPMENT AND PACKAGING

The symbol found on the equipment indicates that the waste must be "collected separately".



Therefore, the user shall take the waste to the separate waste collection points arranged by local authorities, or deliver it to the sales dealer against purchase of equivalent equipment (only in Europe). The separate collection of waste and subsequent treatment, recovery and disposal operations promote the production of equipment using recycled materials and reduce the negative effects on the environment and health that improper waste management can

cause.

Fraudulent disposal of the product will result in an administrative fine being imposed on the user by Authorities according to local Law.



## Some important notes on contacting our after-sales customer service:

In case the **equipment does not work**, it is possible to open a service ticket via the customer service section of the [www.chinesport.com](http://www.chinesport.com) website.

### PLEASE NOTE:

Before calling our customer service department, be sure to have your **SERIAL NUMBER** or "CODE and ARTICLE" at hand: you can find these on the product label located on the equipment (as shown in the image), or the delivery note/invoice number. This identification number helps reduce waiting times and improves service quality.

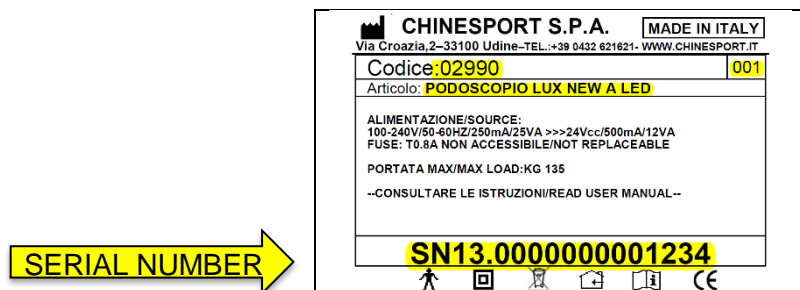

Alternatively, you can contact Customer Service by e-mail ([assistenza@chinesport.it](mailto:assistenza@chinesport.it)). Users without an internet connection can send a fax (0432 621 698) or phone (0432 621 699), but our response time could be longer.

## Alcune indicazioni importanti per contattare il nostro servizio post-vendita:

In caso di guasto è possibile aprire un ticket di assistenza tramite il nostro sito [www.chinesport.it](http://www.chinesport.it) alla sezione Assistenza.

### Attenzione:

Rilevare sempre il "NUMERO DI MATRICOLA" o in alternativa "CODICE e ARTICOLO" riportato sull'etichetta di prodotto posta sull'apparecchiatura (vedere evidenza nel fac-simile sotto riportato), oppure il n° del DDT/bolla o fattura. La sua identificazione riduce i tempi e migliora la qualità dell'intervento.

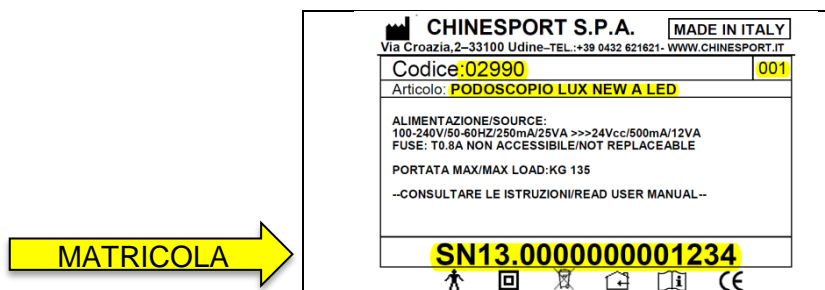

In alternativa è sempre possibile contattare l'assistenza tecnica tramite email ([assistenza@chinesport.it](mailto:assistenza@chinesport.it)); per gli utenti sprovvisti di connessione internet resta sempre possibile inviare un fax (0432 621 698) o telefonare (0432 621 699), ma i tempi di risposta potrebbero essere molto più lunghi.