



GIMA

PROFESSIONAL MEDICAL PRODUCTS

ECG PALMARE CARDIO B CARDIO-B PALM ECG ECG DE POCHE CARDIO B ECG PALMAR CARDIO B

REF 33261 / PC-80B



Shenzhen Creative Industry Co., Ltd.
Floor 5, BLD 9, BaiWangxin High-Tech Industrial Park,
Songbai Road, Xili Street, Nanshan District,
518110 Shenzhen, P.R. China
Made in China



Shanghai International Holding Corp. GmbH (Europe)
Eiffestrasse 80, 20537 Hamburg - Germany

Importato da / Imported by / Importé par / Importado por:
Gima S.p.A.

Via Marconi, 1 - 20060 Gessate (MI) Italy
gima@gimaitaly.com - export@gimaitaly.com

www.gimaitaly.com



WARNING

1. Check the device to make sure that there is no visible damage that may affect user's safety and measurement performance. Stop using the unit, when there is obvious damage.
2. Do NOT make diagnosis oneself by the measurement and measurement results, always consult the doctor if abnormal information is presented frequently.
3. It is NOT designed or intended for medical diagnosis.
4. **WARNING for PACEMAKER PATIENTS**
Heart rate calculation may also count the pacemaker pulse for the patient who carries a cardiac pacemaker because of no pacemaker pulse rejection capability for the device. Do not rely entirely upon the heart rate reading of this device for pacemaker patients.
5. Do NOT use the device in the bathroom or moist circumstance.
6. Do NOT operate in the environment where strong electro-magnetic interference exists.
7. The device is not equipped with detachable parts, the user should NOT take its shell apart without permission.
8. Connect/Disconnect data cable to the monitor gently and carefully, do NOT wring or shake the data cable plug with force to insert into or unplug from data interface port, or the data interface port may be damaged.
9. All the parts of the monitor should NOT be replaced at will. If necessary, please use the components provided by the manufacturer or those that are of the same model and standards as the accessories along with the monitor which are provided by the same factory, otherwise, negative effects concerning safety and biocompatibility etc. may be caused
10. Necessary service must be performed by qualified service engineers ONLY.
11. In case of ECG leads damage or aging, please replace the lead.
12. Electric parts of electrodes, leads and cable are forbidden to contact any other conductive parts (including the ground).
13. Use only one type of electrode on the same patient to avoid variations in electrical resistance. It is strongly recommended to use silver/silver chloride electrodes to ensure accurate measurement result.
14. Use of this equipment adjacent to or stacked with other equipment should be avoided because it could result in improper operation. If such use is necessary, this equipment and the other equipment should be observed to verify that they are operating normally.
15. Use of accessories, transducers and cables other than those specified or provided by the manufacturer of this equipment could result in increased electromagnetic emissions or decreased electromagnetic immunity of this equipment and result in improper operation.
16. Portable RF communications equipment (including peripherals such as antenna cables and external antennas) should be used no closer than 30 cm (12 inches) to any part of the Monitor, including cables specified by the manufacturer. Otherwise, degradation of the performance of this equipment could result.

When disposing of the device and its accessories, the local law should be followed.

Caution: U.S. federal law restricts this device to sale by or on the order of a physician.











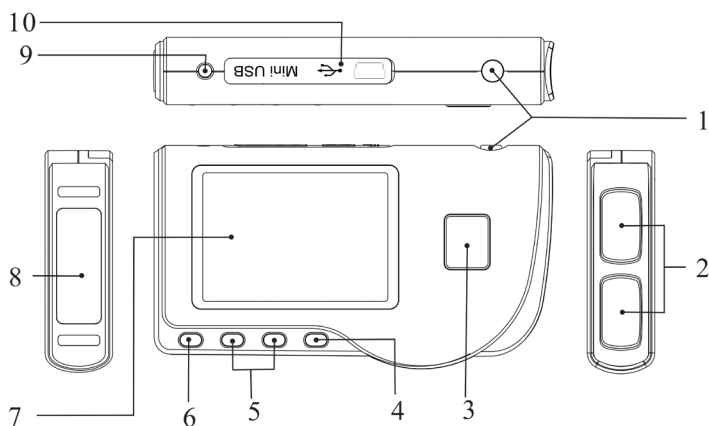

Figura 1 Illustrazione dell'apparecchio

1 Overview

1.1 Appearance

1.  Power: Long time press (about 2 seconds) makes the device power on or off; short time press turns on/off the backlight.
2. Metal Electrode I, II

3.  Measurement: shortcut button for measuring, press this button to start measuring.
4.  OK: confirm selection or modification.
5. Navigation key:
 -  /  Up/left/increase: move the cursor upwards/to the left, or adjust parameter values.
 -  /  Down/right/decrease: move the cursor downwards/to the right, or adjust parameter values.
6.  Return: back to upper level of menu.
7. Display screen: display ECG waveforms and data.
8. Metal Electrode III
9.  ECG Lead wire connector: for connecting to lead wire.
10.  Data interface: for connecting Mini USB data cable.

1.2 Name and Model

Cardio-B Palm ECG Monitor

1.3 Structure

Cardio-B Palm ECG Monitor consists of main board, panels and electrodes.

1.4 Features

1. Small in size and light in weight to carry.
2. One-key measurement, easy to operate.
3. ECG waveform and interpretation of results are displayed clearly on dot-matrix LCD screen.
4. Seventeen types measurement result can be presented.
5. Up to 1200/2700 pieces of records for quick measurement, or 10-hour/22.5-hour data recording for continuous measurement, the data storage depends on the provided size of the built-in memory.
6. Data records can be reviewed, copied, deleted, and uploaded as well.
7. Power saving technique with automatic shutting-down function.
8. Two AAA batteries are used to support more than 10 hours working time. (Wireless transmission function is disabled).
9. Wireless data upload function (optional).

1.5 Intended Use

Cardio-B Palm ECG Monitor is intended for measuring and recording the ECG signal and average heart rate of adult patient. It is applicable for use in clinics and homes, and convenient to operate by the patients themselves.



The device is not an ECG monitor as used in clinical institution or hospital, but is used for spot-check purpose ONLY. It can not be used to substitute the normal ECG examination or real time monitoring. The measurement results are a useful reference for doctor, but do not make direct diagnostic or analytical decision based on the information provided by this device.

1.6 Operating Environment

Operating temperature 5~40°C

Operating humidity 30%~80%

Atmospheric pressure 70kPa~106kPa

2 Installation

1. Open the battery cover (see the Figure 2-1).
2. Insert two AAA size batteries directly.
3. Close the battery cover.



Do NOT insert batteries with their polarities reversed. Dispose of the used batteries according to applicable local regulations.

3 Operation

3.1 Start to measure ECG

Press the Power button (lasting for 2 seconds) to turn on the unit. The unit starts to initialize, and displays the following pictures.

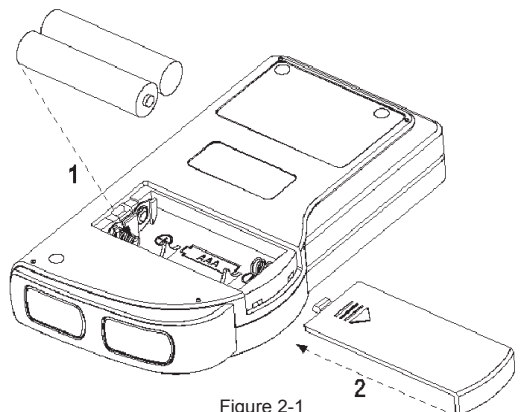

Figure 2-1

After boot-strap, the unit enters into menu screen, as shown in Figure 3-2.

Note: During initialization, press “ Return” button to enter into main menu screen, as shown in Figure 3-2. If press “ Measurement”, it will enter into measuring screen, as shown in Figure 3-4.

There are 6 tool buttons, press navigation key to shift cursor and press “ OK” to confirm. Each functional button will be defined as follows:

Measure: detect ECG waveform and HR value, and analyze whether the ECG waveform is normal.

Review: review the ECG records saved in this device (including ECG waveform and measurement result).

Memory: check the storage space and delete the ECG records saved in this device.

Setting: set parameters such as date, time, language, beeper, filter mode, brightness, and wireless etc.

Help: provide the user with measuring methods etc. information.

Language: **Set the display language.** This device is designed with dual-language: (Italian) and English, which can be switched alternatively by user.

3.2 ECG Measurement

3.2.1 Quick and Short ECG Measurement

Chest Measurement

In order to obtain ideal ECG signal, chest measurement is the first recommended method for it can ensure stable signal and fewer interference. Hold the device with the right hand. Make sure that the palm and fingers touch the metal electrode I and II reliably. Place the electrode III on bare skin about 5cm below the left nipple. The ECG signal detected by Chest Measurement is similar to Lead V ECG signal.

Possible improper operation:

- A. The contact place of electrode III deviates from left chest.
- B. The holding gesture is incorrect.
- C. The electrode can not contact bare skin completely. (For example place the electrode on clothing.)

Leg Measurement

If it is not convenient to adopt chest measurement, the leg measurement will be recommended. When measuring, hold the device with the right hand. Make sure that the palm and fingers touch the metal electrode I and II reliably. Place the electrode III

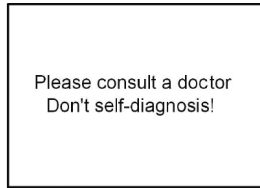

Figure 3-1A

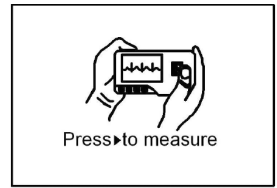

Figure 3-1B



Figure 3-2

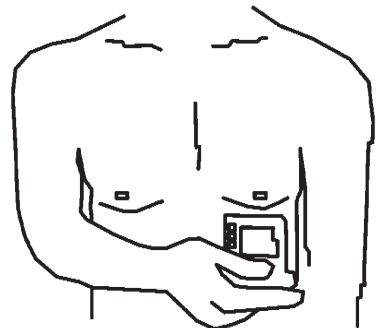

Figure 3-3A Chest Measurement

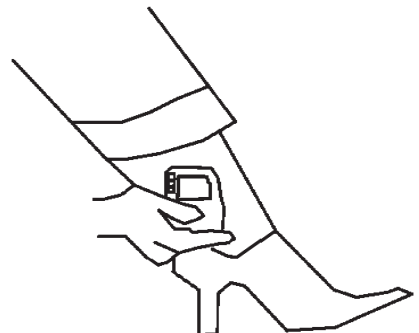

Figure 3-3B Leg Measurement

on the skin 10cm above the left foot ankle. The ECG signal detected by Leg Measurement is equivalent to Lead II ECG signal.

Possible improper operation:

- A. Wrong holding gesture.
- B. The electrode III can not contact bare skin completely. (For example, place the electrode III on the sleeve of trousers or socks.)

Palm Measurement

Palm Measurement is recommended in terms of convenient and quick measurement. Hold the device with right hand. Make sure that the palm and fingers touch the metal electrode I and II reliably. Press the electrode III closely against the center of the left palm. The ECG signal detected by Palm Measurement is equivalent to Lead I ECG signal.

Possible improper operation:

- A. Waving your both hands at will.
- B. Both hands loosely contact with electrodes during measurement.
- C. It is not palm contacts the electrode.

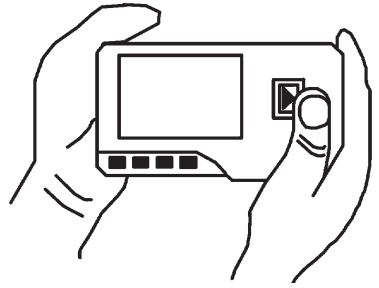

3-3C Palm Measurement

3.2.2 Continuous or Long-term ECG measurement

Lead Wire Measurement

To obtain clear and high quality ECG signal, the lead wire measurement can be used. Connect the lead wire firmly to the lead wire socket of the device. Place the electrodes and connect the lead wires as Figure 3-3D to obtain the Lead II ECG signal; if you want to measure Lead I and Lead III ECG signal, according to the following table to connect the lead wires to the electrodes.

Possible improper operation:

- A. Wrong in connecting lead port.
- B. Place the electrode in the wrong part of your body.

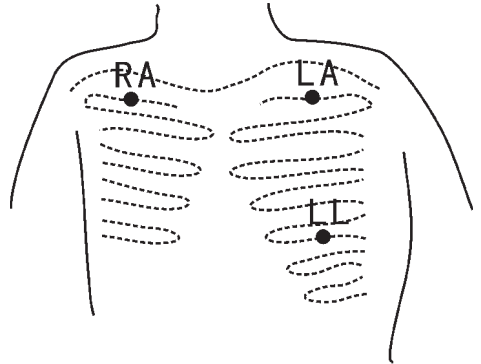



Figure 3-3D Lead Wire Measurement

Electrode Name	Lead	Lead I	Lead II	Lead III
		Electrode location		
	The intersection between the centerline of the right clavicle and Rib 2.	R/RA	R/RA	L/LA
	The intersection between the centerline of the left clavicle and Rib 2.	F/LL	L/LA	R/RA
	Between the left edge of the breast bone and Rib 5	L/LA	F/LL	F/LL

ECG Leads Configuration and Electrodes Location Table

3.3 ECG Measuring Procedure

3.3.1 Quick Measurement

1. After choosing a proper measuring method as described in Chapter 3.2.1, press  "Measure" to enter quick ECG measurement automatically, as shown in Figure 3-4. The first 15 seconds is preparing phase during which the device will judge whether the position of electrode is befitting or not according to measured ECG waveform. Please adjust your holding position if the detected waveform is not smooth.

On-screen display:

1. "16: 14: 32": Current time.
2. "X1": ECG waveform gain.
- "X1/2": Waveform scaled with half of the basic gain;
- "X1": Waveform scaled with basic gain;
- "X2": Waveform scaled with twice of the basic gain
- "X3": Waveform scaled with three times of the basic gain
3. "♥": Heart beat mark. Its flashes are synchronized with heart beats.
4. "⏏": Indicating that ECG filter mode is "Enhanced"; Refer to section 3.6.5 for filter setting.
5. "🔋": Status of battery power
6. "ECG waveform": ECG waveform
7. "1mV ruler": Ruler for 1mV amplitude
8. "Compact compression of scaled waveform": Compact compression of scaled waveform.
9. "📶": Wireless mark (optional). When the "Wireless" is set as "ON" status in system setting screen, this mark will display on the screen. After a successful connection between the device and the remote host, the ECG data can be uploaded to the host (PC) for further recall, analysis and storage.

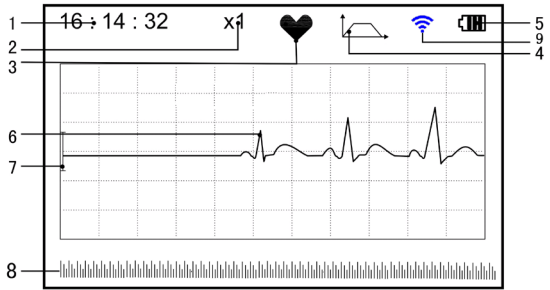

Figure 3-4 ECG Measuring Screen

2. When the compact compression of scaled waveform reaches to the end, it means the measurement finishes, then the device steps into data analysis phase which is followed by measurement results display as shown in Figure 3-5.

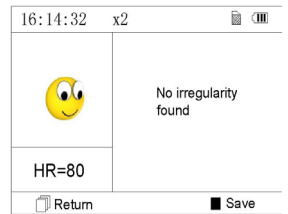

Figure 3-5 Measurement Result Screen

3. In the measurement result screen, the current measurement data will be saved in this device automatically without any operation in 6 seconds or directly press the "Save" key to save the data, as shown in Figure 3-6. The device will return to the main screen automatically after the data is saved.
4. If the wireless transmission is selected, the device will go to the screen as shown in Figure 3-7 after the data is saved.

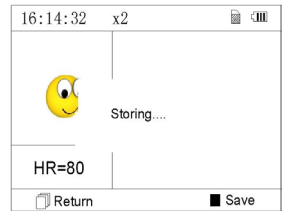

Figure 3-6 Data Saving

Press the "Send" key on the device side to start transmitting ECG record wirelessly, and on the host side, the "Wireless Receive" icon should be clicked while running software "ECG Viewer Manager" on PC so that the data records can be transmitted and saved to PC. After that the device will return to the main screen automatically. (Refer to User Manual for "ECG Viewer Manager" for detailed operation procedure).



Figure 3-7

3.3.2 Continuous Measurement

1. After choosing the continuous measuring method as described in Chapter 3.2.2, press the "Measure" to perform continuous ECG measurement automatically as shown in Figure 3-8. The difference between the continuous and quick measurement is described below:
 - "Exit": the prompt information of operation on the screen. Press the "Return" button to end the ECG measurement and return to the main screen. If the time of continuous measurement is over 30 seconds, this data will be saved automatically.
 - "HR=59": indicates the real-time heart rate.

2. During the continuous measurement, if the wireless transmission function is selected and a successful connection is setup, click the "Wireless Receive" icon on the host side while running software "ECG Viewer Manager" on PC

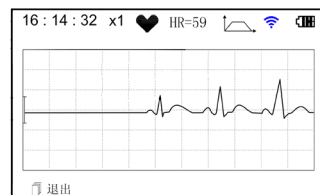



Figure 3-8

so the data record can be transmitted and saved to PC (Refer to User Manual for “ECG Viewer Manager” for detailed operation procedure.). The data measured in wireless real-time transmission status won't be stored in the unit.

- If there is no operation after the continuous measurement has been carried out for 3 minutes, the unit will adopt power-saving mode automatically (the screen will darken), but the measurement won't be interrupted. Once you press any button or the alarm event occurs, the system will exit power-saving mode, and the screen resume to normal brightness.

Notes: 1) Figure 3-5 shows a regular ECG waveform measurement result, this device can provide 17 types measurement results, refer to Table 3-1(Section 3.4.3) for details.

2) During measurement, if the measured part and metal electrodes loosely contact, the device will prompt “Contact?”, as shown in Figure 3-9. If there isn't signal, it will prompt “No signal”. The user can press “ Return” button to exit from the measurement.

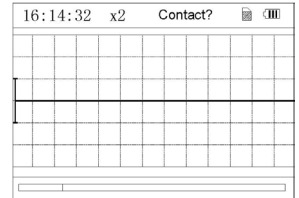



Figure 3-9

3) The device provides built-in 16MB/32MB memory clips (selecting “Memory” on main menu screen to see the detailed memory space), at most 1200/2700 data records for quick measurement or 10-hour/22.5-hour data records for continuous measurement can be saved in this device, and when the device connects to PC successfully, it works as a removable USB disk which contains four files, and 300/720 pieces of quick measurement can be recorded in each file.

4) When the storage space is full, the device will indicate and prompt that “Memory full! Overwrite record?” with a display of “” mark as shown in Figure 3-10. Meanwhile, from now on, it won't store the new record until the user manually deletes the unnecessary data or upload the records to PC to free some memory.

5) The device will power off automatically if there is no any key operation or signal inputting for a while.

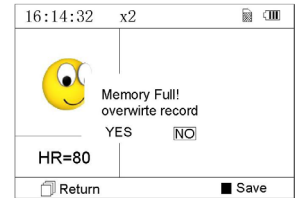



Figure 3-10

3.4 Wave Review

3.4.1 Operation Description

- Select “Review” on main menu screen, then press “ OK” button, the device enters record list screen as shown in Figure 3-11

Note:

“”: means the measured result of this record is regular.

“”: means the measured result of this record is irregular.

“”: means waveform with interference or lead off during measuring.

“”: If the enhanced mode is used, the icon of enhanced mode will be shown behind the record.











Records	1/32		
30/08/2012 09:37:22			
30/08/2012 09:25:21			
30/08/2012 08:34:22			
30/08/2012 07:37:12			
30/08 08:36:08–30/08 08:56:10			

Figure 3-11 Record List

NOTE: There is no such legend icon display for the record of continuous measurement. Only the start and end measuring time (not including the year) is displayed here.

- Choose a record in record list, then press “ OK” button to review this ECG record, the waveform display for quick measurement and continuous measurement are shown in Figure 3-12 and Figure 3-13 respectively. To stop auto replay, just press the Navigation key “/ ” or “/ ”. After that you can press the Navigation key “/ ” or “/ ” again to view the waveforms manually.

On-screen display:

- “16: 14: 32”: ECG waveform measuring time.
- “X1””: ECG waveform gain. There are 4 options available:
 - “X1/2””: Waveform scaled with half of the basic gain;
 - “X1””: Waveform scaled with basic gain;
 - “X2””: Waveform scaled with twice of the basic gain
 - “X3””: Waveform scaled with three times of the basic gain

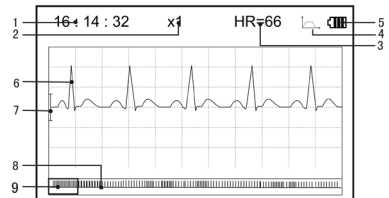

Figure 3-12 ECG Data Review Screen (Quick Measurement)

3. “HR=66”: heart rate value is 66bpm. For waveform review of continuous measurement, the heart rate value won't be displayed. “1/2”: the screen page description for waveform review of continuous measurement. “1”: current page, “2”: total page.

4. : Indicating that ECG filter mode is “Enhanced”.
5. : Status of battery power
6. : Reviewed ECG waveform
7. : Ruler for 1mV amplitude
8. : Compact compression of scaled waveform.
9. : ECG waveform selecting box.

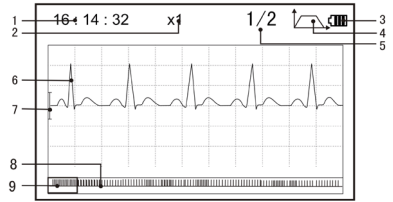

Figure 3-13 ECG Data Review Screen (Continuous Measurement)

Note: The selected waveform in selecting box is displayed on the current screen. ECG waveform miniature in selecting box is the ECG waveform measured in 30 seconds.

3. Press “ OK” button again, the measurement result of the selected record will be reviewed on the screen, as shown in Figure 3-14.

- “ Return”: press “ Return” button to return to record list screen.
- “ Delete”: press “ OK” button to delete the selected current record, at this time it prompts that “Sure to delete?”, as shown in Figure 3-15. If the wireless transmission function is selected, here prompts “ Send” instead. Press the “ Send” button on the device, then on the host side, click the “Wireless Receive” icon while running the software “ECG Viewer Manager” on PC, the data will be transmitted and saved on PC.

4. Select “YES”, then press “ OK” button to perform deletion and return to record list screen. Press “ Return” button directly, this record will not be deleted and the screen will return to record list screen.

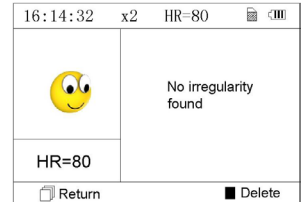

Figure 3-14



Figure 3-15

3.4.2 Measurement Result Description

When device detects lead off or suspected arrhythmia ECG waveform, “Poor signal, Measure again (Figure 3-16)”, “Suspected a little slow beat (Figure 3-17)” etc. 17 types ECG measurement results can be obtained. Refer to the following Table for details.

NOTE: Figure 3-16 and Figure 3-17 show the measurement results by continuous measuring method. The measurement by result continuous measuring method is shown on the left. If one screen hasn't enough space to show all the measurement results, the user can press Navigation Key “ / ” or “ / ” to manually shift the screen upwards or afterwards.

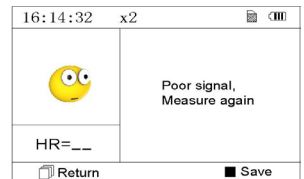

Figure 3-16 (1). Poor signal

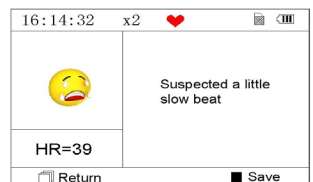
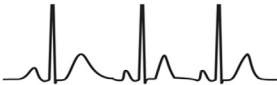
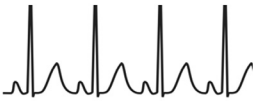
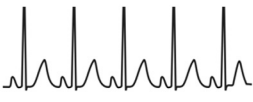
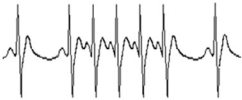

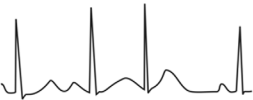
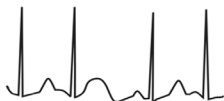

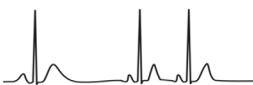
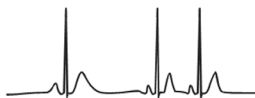

Figure 3-17 (2). A little slow beat

3.4.3 Measurement Result Table

N.	ECG Measurement Result Descriptions	Waveform
1	No irregularity found	
2	Suspected a little fast beat	
3	Suspected fast beat	
4	Suspected short run of fast beat	
5	Suspected a little slow beat	
6	Suspected slow beat	
7	Suspected occasional short beat interval	
8	Suspected irregular beat interval	
9	Suspected fast beat with short beat	
10	Suspected slow beat with short beat interval	
11	Suspected slow beat with irregular beat interval	

N. ECG Measurement Result Descriptions

- 12 Waveform baseline wander
- 13 Suspected fast beat with baseline wander
- 14 Suspected slow beat with baseline wander
- 15 Suspected occasional short beat interval with baseline wander
- 16 Suspected irregular beat interval with baseline wander
- 17 Poor Signal, measure again

Waveform



3.5 Data Management

3.5.1 Data Deletion

Select "Memory" on main menu screen, then press **OK** button to enter memory screen, as shown in Figure 3-18.

Note: the used space plus the unused space equals to the total memory size (16MB/32MB).

Return: press **Return** button to return to main screen.

Delete: press this key to delete all the records. Prior to deletion, a dialogue box "Sure to delete all?" will be presented on the screen, as shown in Figure 3-19. If choose "YES" and press **OK** button, all the records will be deleted, as shown in Figure 3-20.

Note: The operation of data deletion carried out in the memory screen means all the data in the device will be deleted; if you only want to delete one record, please do that on waveform review screen.

3.5.2 Upload Data

Connect the device to PC with USB data cable, the device will automatically enter the upload display as shown in Figure 3-21. The data can be dumped to PC for data management, review and analysis.

Note: Ensure there is sufficient battery power when deleting or uploading the data since insufficient power may cause the interruption of operation.

3.6 System Setting

On the main menu screen, select "Setting", then press **OK** button to enter system setting screen, as shown in Figure 3-22 and Figure 3-23

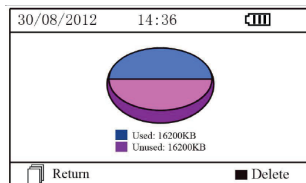

Figure 3-18 Memory Screen

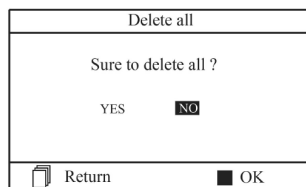

Figure 3-19

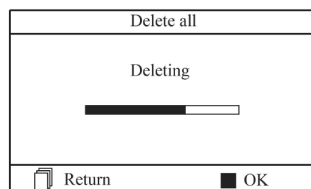

Figure 3-20 Records Deleting

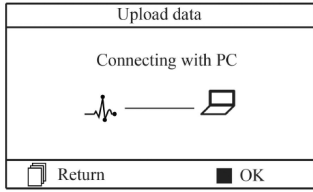

Figure 3-21 Upload Data Screen

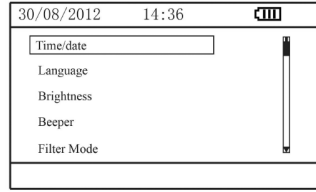

Figure 3-22

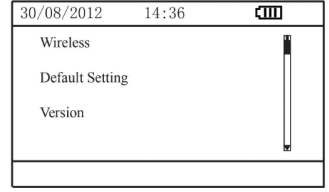

Figure 3-23

3.6.1 Time/Date Setting

1. On system setting screen, select "Time/date" with Navigation Key, then press "OK" button to enter time and date setting screen (date format: dd/mm/yyyy), as shown in Figure 3-24.
2. Use Navigation Key to adjust the value, and then press "OK" button to shift black cursor and adjust another value.
3. When finishing the settings, press "OK" button to save the setting and return to the upper level menu screen.

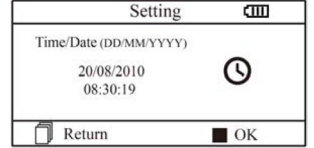

Figure 3-24 Time/date Setting

3.6.2 Language Setting

1. On system setting screen, select "Language" to enter language information screen, as shown in Figure 3-25.
2. Press the Navigation Key to select the language between "Italian" and "English".
3. Press "OK" button to save setting and return to the upper level menu screen..

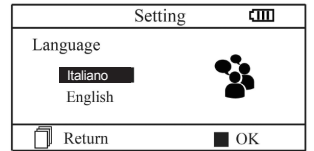

Figure 3-25 Language Setting

3.6.3 Brightness Setting

1. On system setting screen, select "Brightness" to enter brightness setting screen, as shown in Figure 3-26.
2. Adjust brightness with Navigation Key; 1~7 level adjustable;
3. Press "OK" button to save setting and return to the upper level menu screen.

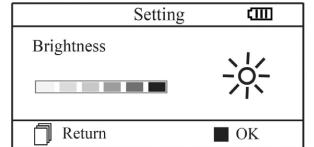

Figure 3-26 Brightness Setting

3.6.4 Beeper Setting

1. On system setting screen, select "Beeper" to enter beeper setting screen, as shown in Figure 3-27.
2. Choose "ON" or "OFF" with Navigation Key to turn on the beeper or turn off the beeper; the default setting is "ON".
3. Press "OK" button to save setting and return to the upper level menu screen.

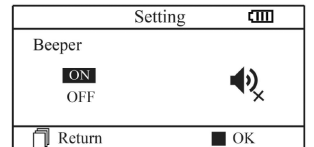

Figure 3-27 Beeper Setting

3.6.5 Measure Mode Setting

1. On system setting screen, select "Measure mode" to enter measure mode setting screen, as shown in Figure 3-28.
2. Choose "Normal" mode or "Enhanced" mode with Navigation Key. The default setting is "Normal" mode.
Normal mode: can filter the interference signal in ECG waveform.
Enhanced mode: can better reflect the fidelity of ECG waveform.
3. Press "OK" button to save setting and return to the upper level menu screen.

3.6.6 Wireless Setting

1. On system setting screen, select "Wireless" to enter wireless setting screen, as shown in Figure 3-29.
2. Press the Navigation Key to turn on or turn off the wireless function.
3. Press "OK" button to save setting and return to the upper level menu screen.

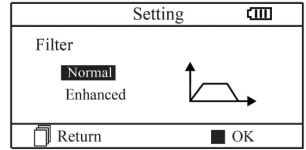

Figure 3-28 Measure Mode Setting

Downloading the APP software for smart phone

The terminal devices such as smart phone can be used to receive data from the Easy ECG Monitor in real-time, and store the received data, review the stored data as well.

You have to download the corresponding APP software on the smart phone.

For terminal devices with the Android system, please follow the procedure to download:

1. Install an APP software for scanning QR Code by smart phone, such as QuickMark, I-Nigma, Bee Tagg etc..
2. Run the APP software to scan the QR Code image in below figure, please focus the QR Code frame while scanning.
3. If successful scanned, then the scanning result, that is a web link for downloading the APP software "PC-80B. apk" will be displayed on the smart phone.
4. Open this web link by a web browser to download the APP software "PC-80B.apk". Install this APP software if successful downloaded.

For terminal devices with the iOS system (such as iPhone, iPad), please follow this procedure to download:

1. On the App Store of the device, enter "Shenzhen Creative" into the search line.
Note: if you use an iPad to search, please select "iPhone only" when searching.
2. Once the search results are listed, select the result with @health icon "", then download the corresponding APP software.

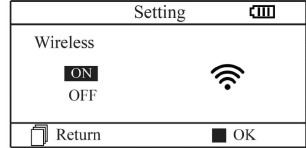

Figure 3-29 Wireless Selection



Instruction for Measurement

Make sure the APP software is successful to connect with the Easy ECG Monitor.

Refer to the manual of this APP software for detail operating.

*Note: APP software for PC and Android smart phone is also available for download from below link:
<http://www.creative-sz.com>*

3.6.7 Resume Default

1. On system setting screen, select "Default setting" to enter into default setting screen, as shown in Figure 3-30.
2. Choose "YES" or "NO" with Navigation Key. If the choice is "YES", then press "OK" button, all the parameter settings will resume default settings.
3. Press "Return" button to back to upper level menu.

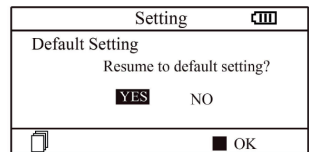

Figure 3-30 Default Setting

3.6.8 Version Info

On system setting screen, select "Version" to enter version information screen, as shown in Figure 3-31. "V52-10-10" is version number(refer to the actual version).

3.7 Help

On main menu screen, select "Help", then press "OK" button to enter help info screen. It provides different kinds of illustrations for ECG measuring methods. Refer to Section 3.2.1 for ECG measuring methods in details.

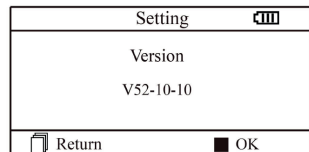

Figure 3-31 Version information

4 Technical Specifications

4.1 ECG Measurement

Number of channels: Single channel ECG signal

Electrodes: 3 embedded metal electrodes or using 3 adhesive ECG electrodes by connection to the lead wire.

Measurement modes: the detecting ECG signal can be detected by the following lead selection:

Lead I (between right hand and left hand);

Chest Lead (between right hand and chest);

Lead II (between right hand and left leg).

ECG bandwidth: 1Hz~40Hz

Internal noise level: $\leq 30\mu\text{Vp-p}$

Heart Rate measuring range: 30bpm~240bpm

Heart Rate measuring accuracy: $\pm 2\text{bpm}$ or $\pm 2\%$ whichever is greater

Display scale: 5.0mm/mV $\pm 10\%$

Common-mode rejection ratio (CMRR): $\geq 60\text{dB}$

Waveform sweeping speed: 20mm/s $\pm 10\%$

Input loop current: $\leq 0.1\mu\text{A}$

Input impedance: $\geq 5\text{M}\Omega$

4.2 Power

Power: 2×AAA alkaline batteries

Supply voltage range: 2.7~3.3VDC

Max average working current: $\leq 50\text{mA}$

Auto power-off: 35s $\pm 5\text{s}$ (without operation)

Low battery indication: 2.5VDC $\pm 0.2\text{VDC}$

4.3 Classification

The type of protection against electric shock: Internally powered equipment

The degree of protection against electric shock: Type BF applied part

The degree of protection against harmful ingress of liquid: Ordinary equipment without protection against ingress of liquid.

Electro-magnetic Compatibility: Group I, Class B

4.4 Display

LCD type: colour LCD

Display area: 57.6mm × 40mm

4.5 Data Memory

Up to 10-hour records can be saved in the built-in memory;

Stored data records can be uploaded to the computer by data cable provided by the manufacturer.

4.6 Overall Dimension and Weight

Dimension: (L) 125 × (W) 70 × (H) 21.5 mm

Weight: 106g (not including batteries)

5 Accessories

Two batteries (AAA)

A wallet

A User Manual

A data cable (optional)

An ECG lead wire (optional)

Note: The accessories are subject to change. Please see the Packing List for detailed items and quantity.

6 Maintenance and Service

6.1 Maintenance

The life of this device is 5 years. In order to ensure its long service life, please pay attention to the maintenance.

Please change the batteries, when appears low-voltage icon.

It is recommended to wipe the metal electrode with medical alcohol, when the measuring signal is too weak.

Please wipe the surface of the unit with clean cloth or let it dry in air.

Please take out the batteries if the unit will not be used for a long time.

Storage and Transportation

Ambient temperature: -20 to 60°C

Relative humidity: 10~ 95%

Atmospheric pressure: 50~107.4KPa



This device should be transported by land (vehicle or railway) or air in accordance with the contractual terms. Do not hit or drop it with force and protect it from sunlight and rain. Keep it away from corrosive substances, explosive substances, high/low temperature and moisture. If the device gets wet or has water steam, please stop operating it. When it is taken from cold environment to warm and humid environment, please DO NOT use it immediately. DO NOT operate the button on front panel with sharp materials. DO NOT immerge the device into liquid. Do NOT spray any liquid on it directly. The life of this unit is 5 years. In order to ensure its long service life, please pay attention to the use of maintenance.

6.2 Cleaning and Disinfecting Instruction

Surface-clean sensor with a soft gauze by saturating with a solution such as 75% isopropyl alcohol, if low-level disinfection is required, use a 1:10 bleach solution. Then surface-clean with a damp cloth and dry with a piece of cloth.



Caution: Do not sterilize by irradiation steam, or ethylene oxide.

7 Troubleshooting

Trouble: The device can not turn on.

Possible Reason	Solution
<ol style="list-style-type: none"> 1. The batteries are drained or almost drained. 2. The batteries are not inserted properly. 3. The device is broken out. 	<ol style="list-style-type: none"> 1. Change batteries. 2. Reinstall batteries. 3. Please contact the local service center.

Trouble: The device is failure in measuring heart rate.

Possible Reason	Solution
<ol style="list-style-type: none"> 1. Electrode does not contact body well. 2. Movement when measuring. 3. Electromagnetic interference. 4. Weak signal. 	<ol style="list-style-type: none"> 1. Place the electrode correctly. 2. When measuring, please keep quiet and avoid moving. 3. Keep away from interference source. 4. Change a place (chest) to measure.

























Trouble: ECG waveform excursion, strong irrelevant waveform or the ECG waveform displays on the screen, but the prompt info is "Contact?"

Possible Reason	Solution
<ol style="list-style-type: none"> 1. Skin is dry or oily. 2. Electrode does not contact body tightly. 3. Muscle strain. 	<ol style="list-style-type: none"> 1. Clean skin with soap and water and eliminate skin crumb and grease to make the skin wet and greaseless. 2. Press the electrode with a certain force. 3. Keep hand relax while measuring.

8 Error Message and Solutions

Error	Reason	Solution
Communication error.	The communication is interfered or abnormal.	<ol style="list-style-type: none"> 1. Press the "Return" button to exit from current status. 2. Ensure the PC software can operate normally. 3. Restart the wireless function or the device.
Memory full.	The memory of flash is full.	<ol style="list-style-type: none"> 1. Manually delete the ECG record directly. 2. Upload the record to PC, then delete it.

9 Key of Symbols

Symbol	Description	Symbol	Description
	Heart Rate (Unit: beats per minutes)		Navigation key
	Measure mode: enhanced		Data Interface Port
	Battery indicator		Serial number
	Wireless transmission mark		USB data cable interface
	Full memory mark		Medical Device complies with Directive 93/42/EEC
	Return button		Manufacturer
	Power button		Date of manufacture
	Type BF applied part		Product code
	Lead wire socket		Caution: read instructions (warnings) carefully
	Follow instructions for use		WEEE disposal
	Confirmation button		Lot number
	Keep away from sunlight		Keep in a cool, dry place

Note: The symbols , , ,  and  are displayed on the screen, the others are marked on the device panel.



Disposal: The product must not be disposed of along with other domestic waste. The users must dispose of this equipment by bringing it to a specific recycling point for electric and electronic equipment.

GIMA WARRANTY TERMS

The Gima 12-month standard B2B warranty applies.

Appendix

General Knowledge of ECG

Normal sinus rhythm: In sinus conditions, SA node paces the heart with the regularly rate and the normal rhythm. The heart rate is in the range of 60 to 100 times per minute and the rhythm is regular. P wave is normal and each one is followed by a QRS wave. P-R interval: 0.12~0.20s; QRS wave: 0.06~0.10s; No ectopic ECG activity.
Symptom: Sinus rhythm, heart rate: 60~100bpm
Indication: Normal

Several abnormal ECG waveforms

1) **Tachycardia:** The heartbeat becomes faster. Tachycardia is determined by the rhythm of the heart, the average rhythm beats faster than 100 times a minute is considered as Tachycardia. The result description "Suspected fast beat" in this device may be doubted as Tachycardia.

Symptom: heart rate>100bpm

Indication: It may occur with the normal people who have these physiology conditions: rage, fatigue, smoking, drinking too much wine, excessive coffee and strong tea, etc.

Pathology: anemia, Hyperthyroidism, blood hypoxia, myocarditis, hypokalemia, fever, influence of some medication (such as atropine, epinephrine etc.).

Suggestion: If it belongs to pathology condition, please go to hospital.

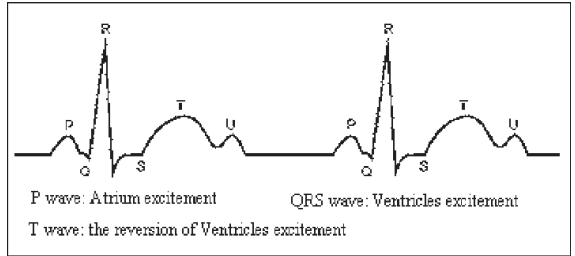

Figure 1 Normal ECG Waveform

2) **Bradycardia:** The heartbeat becomes more slowly. It is determined by the rhythm of the heart, the average rhythm is less than 60 beats per minute is considered as Bradycardia. The result description "Suspected slow beat" in this device may be doubted as Bradycardia.

Symptom: heart rate<60bpm

Indication: It occurs when healthy people fall asleep, and it can be found in athlete (or those who love doing sports frequently), old people, or vagus excitement person.

Pathology: Sick sinus syndrome, Ischemic heart disease, Cardiomyopathy, intracranial hypertension, increased hypokalemia, Low temperature, period of convalescence of acute infectious disease or after use some medicines such as digitalis.

Suggestion: If it belongs to the pathology condition, please see the doctor.

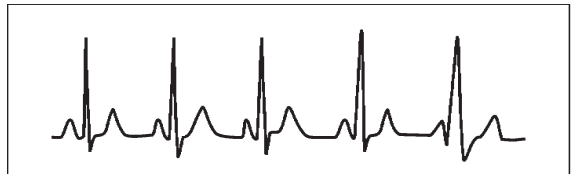

Figure 2 Tachycardia Waveform

3) **Premature beat:** In a normal beat a QRS waveform appears prematurely and is followed by a comeback pause. The result description "Suspected occasional short beat interval" in this device may be doubted as Premature beat.

What is premature beats? It is premature contraction. The normal heart beat is always regularly, and each beat interval is also symmetrically; Premature beat is out of his general regulation, the heart beats prematurely and followed by a long time interval; the phenomena of a premature beat between two heart beats is called inserting premature beat. The display of "early beat" may be suspected Premature beat.

According to different original positions it can be divided into Premature Atrial Contraction, Premature Nodal Contraction and Premature Ventricular Contraction (PVC), which needed to be judged by experts.

Symptom: The heart beat is arrhythmic, it occurs as the phenomenon that the heart suddenly beats and then stops for a while. Some people have palpitation or have no symptom.

Indication: The premature beat can be found occasionally in healthy people, with no distinct symptom or sometimes with palpitation. This may be caused by fatigue, anxiety, insomnia, smoking too much, or drinking too much wine, coffee, strong tea etc. It can be recovered without treatment. However, if premature beat occurs frequently, continuously or in multi-focus, it will indicate functional cardiovascular disease. please see a doctor as soon as possible.

Suggestion: The character of premature beat needs professional to confirm, so please save the temporal figure in time. When seeing a doctor, you can recall it to doctor to judge the character of premature (Premature Atrial Contraction,

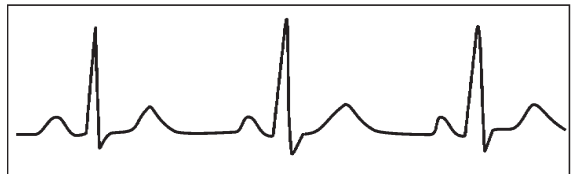

Figure 3 Bradycardia Waveform

Premature Nodal Contraction, Premature Ventricular Contraction or multi-focus premature beat and help cure.

Testee's Symptom: Normal heart beat is followed by a premature beat.

4) **Bigeminy:** It is a type of PVC in which a normal beat is coupled with a premature beat.

Indication: PVC occurs frequently.

Suggestion: Please see the doctor.

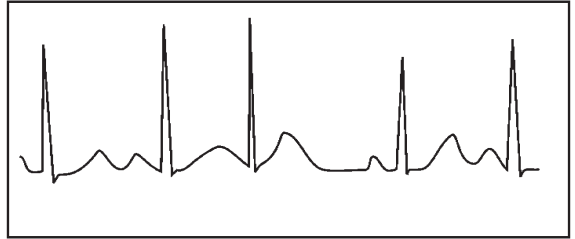

Figure 4 Premature Beat

5) **Trigeminy:** It is a type of PVC in which two normal beats are coupled with a premature beat.

Indication: PVC occurs frequently.

Suggestion: Please see the doctor.

The result description "Suspected irregular beat interval" in this device may be doubted as Bigeminy or Trigeminy.

6) **Short run of tachycardia:** PVC (Premature Ventricular Contraction) occurs more than 3 times continuously.

Testee's Symptom: PVC occurs More than 3 times continuously. The heart beat is fast and regularly, but starts and stops suddenly.

According to the different of active original position, it can be divided into: Short Run, SVE Short Run (Needing professional to judge).

Short Run: It is caused by Premature Atrial Contraction or Nodal Premature Beat, frequency >180bpm.

Indication: Most commonly found in healthy people, it causes by deep respiration, tachypnea, positional changes, swallow, rage etc. It also appears in functional cardiac disease, such as Wolff - Parkinson-White Syndrome, rheumatic heart disease, coronary heart disease, Cardiomyopathy, Congenital heart disease, medicinal reaction (digitalis toxicosis) etc.

Suggestion: If it occurs time after time, please see the doctor as soon as possible.

Ventricular Tachycardia: Caused by Premature Ventricular Contraction, Heart Rate >140bpm.

Indication: Most commonly found in heart disease patient, it can cause ventricle fibrillation if it's serious, so the tester needs to see a doctor immediately.

Suggestion: The character of short run needs professional to confirm, so please save the temporal figure in time. And you can provide it to doctor as a reference.

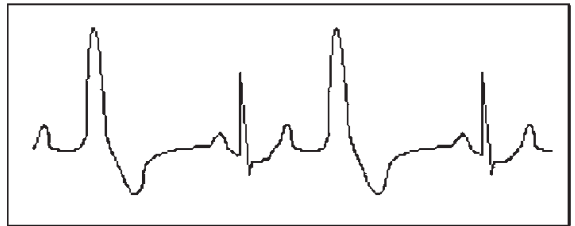

Figure 5 Bigeminy

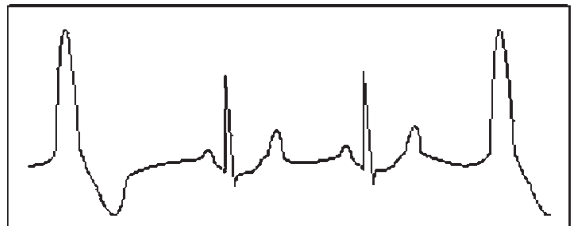

Figure 6 Trigeminy

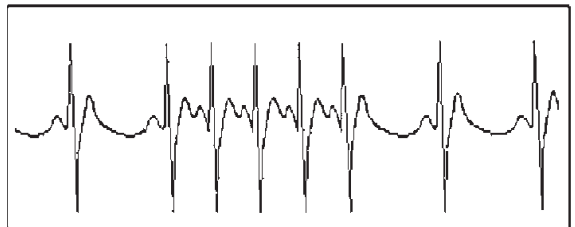

Figure 7 Tachycardia

EMC

The equipment meets the requirements of IEC60601-1-2:2014.

Table 1

Guidance and manufacturer's declaration-electromagnetic emission for all EQUIPMENT AND SYSTEM

Cardio-B Palm ECG Monitor is intended for use in the electromagnetic environment specified below. The customer or the user of ECG Easy Monitor should assure that it is used in such an environment.		
Emissions test	Compliance	Electromagnetic environment-guidance
RF emissions CISPR 11	Group 1	ECG Easy Monitor uses RF energy only for its internal function. Therefore, its RF emissions are very low and are not likely to cause any interference in nearby electronic equipment.
RF emissions CISPR 11	Class B	Cardio-B Palm ECG Monitor is suitable for use in all establishments, including domestic establishments and those directly connected to the public low-voltage power supply network that supplies buildings used for domestic purposes.
Harmonic emissions IEC61000-3-2	N/A	
Voltage fluctuations/flicker emissions IEC61000-3-3	N/A	

Table 2

Guidance and manufacturer's declaration-electromagnetic immunity for all EQUIPMENT AND SYSTEMS

Cardio-B Palm ECG Monitor is intended for use in the electromagnetic environment specified below. the customer or the user of ECG Easy Monitor should assure that it is used in such an environment.			
Immunity test	IEC60601 test level	Compliance level	Electromagnetic environment - guidance
Electrostatic discharge(ESD) IEC61000-4-2	±8 kV contact ±15 air	±8 kV contact ±15k air	Floors should be wood, concrete or ceramic tile. If floors are covered with synthetic material, the relative humidity should be at least 30%.
Electrical fast transient/burst IEC61000-4-4	±2 kV for power Supply lines ±1 kV for input/output lines	N/A	N/A
Surge IEC 61000-4-5	±1kV line (s) to line(s) ±2kV line(s) to earth	N/A	N/A
Voltage dips, short interruptions and voltage variations on power supply input lines IEC61000-4-11	<5% U_T (>95% dip in U_T) for 0.5 cycle 40% U_T (60% dip in U_T) for 5 cycle 70% U_T (30% dip in U_T) for 25 cycle <5% U_T (>95% dip in U_T) for 5 sec	N/A	N/A
Power frequency(50Hz/60Hz) magnetic field IEC61000-4-8	30A/m	30A/m	Power frequency magnetic fields should be at levels characteristic of a typical location in a typical commercial or hospital environment.

NOTE: U_T is the a.c. mains voltage prior to application of the test level.

Table 3

Guidance and manufacturer's declaration – electromagnetic immunity-for EQUIPMENT and SYSTEM that are not LIFE-SUPPORTING

<p>Cardio-B Palm ECG Monitor is intended for use in the electromagnetic environment specified below. The customer or the user of ECG Easy Monitor should assure that it is used in such an electromagnetic environment.</p>			
Immunity test	IEC 60601 test level	Compliance level	Electromagnetic environment - guidance
<p>Conducted RF IEC 61000-4-6</p> <p>Radiated RF IEC 61000-4-3</p>	<p>3 Vrms 150 kHz to 80 MHz</p> <p>3 V/m 80 MHz to 2.5 GHz</p>	<p>N/A</p> <p>3 V/m</p>	<p>Portable and mobile RF communications equipment should be used no closer to any part of ECG Easy Monitor, including cables, than the recommended separation distance calculated from the equation applicable to the frequency of the transmitter.</p> <p>Recommended separation distance</p> $d = 1.2 \sqrt{P}$ $d = 1.2 \sqrt{P} \quad 80\text{MHz to } 800\text{MHz}$ $d = 2.3 \sqrt{P} \quad 800\text{MHz to } 2.5\text{GHz}$ <p>Where P is the maximum output power rating of the transmitter in watts (W) according to the transmitter manufacturer and d is the recommended separation distance in metres (m).^b</p> <p>Field strengths from fixed RF transmitters, as determined by an electromagnetic site survey, should be less than the compliance level in each frequency range.^b</p> <p>Interference may occur in the vicinity of equipment marked with the following symbol.</p> 
<p>NOTA 1 At 80 MHz and 800 MHz, the higher frequency range applies.</p> <p>NOTA 2 These guidelines may not apply in all situations. Electromagnetic propagation is affected by absorption and reflection from structures, objects and people.</p>			
<p>a: Field strengths from fixed transmitters, such as base stations for radio (cellular / cordless) telephones and land mobile radios, amateur radio, AM and FM radio broadcast and TV broadcast cannot be predicted theoretically with accuracy. To assess the electromagnetic environment due to fixed RF transmitters, an electromagnetic site survey should be considered. If the measured field strength in the location in which ECG Easy Monitor is used exceeds the applicable RF compliance level above, ECG Easy Monitor should be observed to verify normal operation. If abnormal performance is observed, additional measures may be necessary, such as re-orienting or relocating ECG Easy Monitor.</p> <p>b: Over the frequency range 150 kHz to 80 MHz, field strengths should be less than 3V/m.</p>			

Table 4
Recommended separation distances between portable and mobile RF communications equipment and The equipment or system for EQUIPMENT and SYSTEM that are not LIFE-SUPPORTING

Cardio-B Palm ECG Monitor is intended for use in an electromagnetic environment in which radiated RF disturbances are controlled. The customer or the user of ECG Easy Monitor can help prevent electromagnetic interference by maintaining a minimum distance between portable and mobile RF communications equipment (transmitters) and ECG Easy Monitor as recommended below, according to the maximum output power of the communications equipment.

Rated maximum output power of transmitter W (Watts)	Separation distance according to frequency of transmitter M (Meters)		
	150kHz to 80MHz $d= 1.2 \sqrt{P}$	80MHz to 800MHz $d= 1.2 \sqrt{P}$	80MHz to 2,5GHz $d= 2.3 \sqrt{P}$
0.01	N/A	0.12	0.23
0.1	N/A	0.38	0.73
1	N/A	1.2	2.3
10	N/A	3.8	7.3
100	N/A	12	23

For transmitters rated at a maximum output power not listed above, the recommended separation distance d in metres (m) can be determined using the equation applicable to the frequency of the transmitter, where P is the maximum output power rating of the transmitter in watts (W) according to the transmitter manufacturer.

Note 1: At 80 MHz and 800 MHz, the separation distance for the higher frequency range applies.

Note 2: These guidelines may not apply in all situations. Electromagnetic propagation is affected by absorption and reflection from structures, objects and people.