



BM3

User's Manual

Patient Monitor

Rev. 3.0

2019.11.22



Warning

To ensure proper use of this medical equipment, you must read and comply with this user manual.

BM3 User Manual

Software© Bionet, Co., Ltd. 2016.

All rights reserved.

Reproduction in any manner, in whole or in part, except for brief excerpts in reviews and scientific papers, is prohibited without prior written permission of Bionet, Co., Ltd.

Before using Bionet devices, read all the manual that are provided with your device carefully.

Patient monitoring equipment, regardless of the complexity of the equipment, should never be used as a substitute for the patient care, attention, and critical judgment that only trained health care professionals can provide.

CAPNOSTAT, LoFlo® is trademark of Respironics.

All other brand or product names are the property of their respective owners.

Table of Contents

Intended Use.....	9
General Description.....	9
Patient Classification	10
Functional safety.....	10
Warning, Caution, Note	11
Define groups.....	12
General precaution on environment.....	13
Electromagnetic Compatibility.....	14
1. Basic	15
Overview	15
Electric safety precautions.....	15
Biocompatibility.....	17
Product Configuration.....	17
Option Product.....	18
Basic Unit.....	19
Device Markings.....	24
Power.....	25
How to replace the battery.....	29
Getting Started.....	31
2. SETUP.....	34
Overview	34

Monitor configuration	34
Main menu setup	35
3. Network	41
Overview	41
Network connection	41
Remote View	42
Display Mode	44
4. Admission and Discharge	46
Overview	46
Patient admission	46
Patient discharge	47
Registration of patient ID using barcode	52
5. Alarm	53
Overview	53
Alarm priority	53
Alarm management	55
Alarm settings	56
Alarm event	57
6. TREND	58
Overview	58
Trend setup	58
Graphical trend	61
Tabular trend	62
File export	63
Popup trend	65

7. ECG	67
Overview	67
ECG Precaution	68
Patient preparation	71
ECG lead	72
ECG signal processing and display	73
ST signal processing and display	74
Alarm and alarm status	74
Display	75
ECG Settings	75
Trouble shooting	78
8. Arrhythmia Monitoring(*)	80
Overview	80
Arrhythmia templette	80
Arrhythmia Settings	81
9. SpO2	83
Overview	83
Precaution	83
Patient preparation	84
Display	85
Quality of SPO2 Waveform	87
SPO2 Settings	88
Status messages	89
10. RESPIRATION	90
Overview	90

RESP precaution.....	90
Patient Preparation.....	91
Display.....	93
RESP Settings.....	94
OxyCRG monitoring.....	94
11. NIBP.....	97
Overview.....	97
Display.....	99
NIBP Settings.....	100
Measurement Limitations.....	103
Status Messages.....	105
12. EtCO2(*).....	106
Overview.....	106
Precaution.....	111
Sampling method.....	112
Display.....	114
EtCO2 setup.....	114
Status Message.....	119
13. Temperature.....	122
Overview.....	122
Display.....	123
Temperature settings.....	124
14. Printer.....	125
Overview.....	125
Printer settings.....	126

Thermal Paper Storage	128
Paper Change	129
15. Maintenance and Troubleshooting	130
Inspection Equipment	130
Inspection Cables	130
Maintenance Task and Test Schedule	131
Noise in ECG	133
SpO2 malfunction	134
Temperature malfunction	134
NIBP malfunction	135
Abnormality in NIBP measurements	135
EtCO2 malfunction	136
Failure in battery recharge	136
Power failure	137
Data storage failure	137
Periodic noises	138
Print failure	138
16. Clean and Care	139
Overview	139
Monitor and Peripherals	139
17. Technical Specification	143
Overview	143
EMC Compatibility (EMC)	143
Manufacturer's declaration - electromagnetic emission	145
Manufacturer's declaration - electromagnetic immunity	146

Guidance and manufacturer's declaration - electromagnetic immunity 152

System Specification 154

Adult & Pediatric-ICU Mode 160

Alarm level..... 160

Neonate-ICU Mode 161

Alarm level..... 161

Parameter Limits..... 162

Display 163

Abbreviations and Symbols..... 164

PRODUCT WARRANTY 169

International Sales & Service Contact..... 170

Intended Use

The BM3 monitor is for multi-parameter patient monitoring. The instrument generates visual and audible alarms when a variety of physiological parameters are monitored over a present limit and time, or where recording begins. This equipment is connected via BM central.

Note

All Bionet hardwares and screenshots in this user guide are for illustration purposes only. Actual products or screens may vary slightly.

General Description

The BM3 monitor can monitor the following:

- Heart Rate
- Respiration Rate
- Non-Invasive blood pressure
- Arrhythmia
- Temperature
- SpO2
- Pulse Rate
- Apnea
- ST segment analysis
- EtCO2(option)
- FiO2(option)

This equipment is designed to be used in an environment where a health care professional can determine when to use the equipment for its intended purpose, based on an expert assessment of the patient's medical condition, including physicians, nurses.

Patient Classification

BM3 monitors are designed for use by adults, pediatrics and neonates. At this time, cardiac output, ST segment analysis and arrhythmia should be used for adults and pediatrics only.

Functional safety

The essential performance of the patient monitor is to provide the clinician with meaningful parameter values and to sound an alarm when the established parameter value is exceeded or the function that provides the value is not working properly. We assessed the risks associated with the use of these monitors in light of these essential performance features and mitigated the risk of lowering the residual risk to a level that could be used without compromise as long as the product maintained its regular lifecycle maintenance and service recommendations.

Warning, Caution, Note

The following terms are defined in the User Guide to emphasize the agreement as follows:

The user must follow all warnings and precautions.

The specifications and functions shown in this manual are subject to change without prior notice.

Warning

"Warning" A warning contains important information regarding possible danger to you or the patient that is present during normal operation of the equipment

Caution

"Caution" A caution provides information or instructions that must be followed to ensure proper operation and performance of the equipment.

Note

"Note" A note presents information that helps you operate the equipment or connected devices.

Define groups

The define groups for this product are users, service personnel, and experts. Define groups should read the user manual before using the product and be trained in the use, installation, reprocessing, maintenance and repair of the product. This product can only be used, installed, reprocessed, maintained and repaired by a defined group.

User

Users use the product for their intended use.

Service personnel

Service personnel are responsible for the maintenance of the product. They must be trained in the maintenance of the medical device, install, reprocess and maintain the product.

Expert

The specialist repairs the product or performs complex maintenance tasks. The expert Have the knowledge and experience to perform complex maintenance tasks on your product.

General precaution on environment

– Do not keep or operate the equipment in the environment listed below.

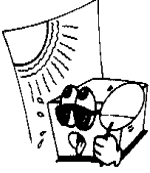
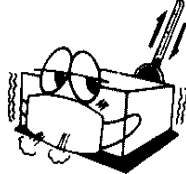
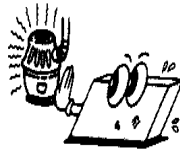
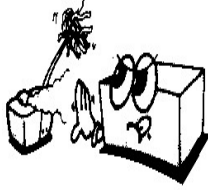
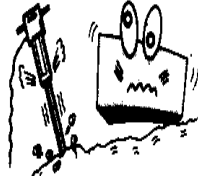
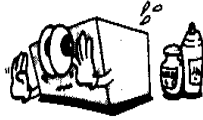
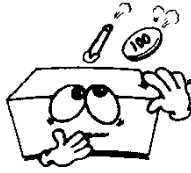
	<p>Avoid placing in an area exposed to moist.</p> <p>Do not touch the equipment with wet hand.</p>		<p>Avoid exposure to direct sunlight</p>
	<p>Avoid placing in an area where there is a high variation of temperature.</p>		<p>Avoid in the vicinity of Electric heater</p>
	<p>Avoid placing in an area where there is an excessive humidity rise or ventilation problem.</p>		<p>Avoid placing in an area where there is an excessive shock or vibration.</p>
	<p>Avoid placing in an area where chemicals are stored or where there is danger of gas leakage.</p>		<p>Avoid being inserted dust and especially metal material into the equipment</p>
	<p>Do not disjoint or disassemble the equipment.</p> <p>We take no responsibility for it.</p>		<p>Power off when the equipment is not fully installed.</p> <p>Otherwise, equipment could be damaged.</p>

Electromagnetic Compatibility

The monitor has been designed and tested for compliance with current regulatory standards as to its capacity to limit electromagnetic emissions(EMI), and also as to its ability to block the effects of EMI from external sources.

The monitor complies with the following standards pertaining to EMI emissions and susceptibility: EN60601-1-2.

To reduce possible problems caused by electromagnetic interference, we recommend the following:

- Use only Bionet approved accessories.
- Ensure that other products used in areas where patient monitoring and life support is used comply to accepted emissions standards (CISPR 11, Class A).
- Try to maximize the distance between electro-medical devices. High-power equipment related to electrical simulators, electrosurgical instruments and radiators (X-ray machines) as well as evoked potential devices may cause monitor interference.
- Strictly limit exposure and access to portable radio frequency sources (e.g. cellular phones and radio transmitters). Be aware that portable phones may periodically transmit even when in standby mode.
- Maintain good cable management. Do not route cables over electrical equipment. Do not intertwine cables.
- Ensure all electrical maintenance is performed by qualified personnel.

Caution
Infectious devices and parts must be sanitized and cleaned before disposal.

1. Basic

Overview

This patient monitor is for adult, pediatric, and neonatal monitoring. It can be used as an independent device or connected to the BM Central network. Use of the monitor is limited to one patient at a time.

The following optional software features are available:

- Arrhythmia analysis.
- 3-lead ST segment analysis.
- It is common to connect B2B VIEWS, and the two connections are optional.
- Wireless network connection

Electric safety precautions

Caution
Please check the following before using the product.

1. Be sure that AC power supply line is appropriate to use. (AC100 - 240V)
2. Be sure that the power source is the one supplied from Bionet.(DC18V, 2.8A, BPM050 Made in BridgePower Co., Ltd.)
3. Be sure that the entire connection cable of the system is properly and firmly fixed.
4. Be sure that the equipment is completely grounded.(If not, there might be the problem occur in the product.)
5. The equipment should not be placed in the vicinity of electric generator, X-ray, broadcasting apparatus to eliminate the electric noise during operation. Otherwise, it may cause incorrect result.

Caution

The Equipment should be placed far from generator, X-ray equipment, broadcasting equipment or transmitting wires, so as to prevent the electrical noises from being generated during the operation, When these devices are near the Equipment, it can produce inaccurate measurements. For BM3 both independent circuit and stable grounding are essentially required. In the event that the same power source is shared with other electronic equipment, it can also produce inaccurate output.

Note

BM3 is classified as follows:

- BM3 classifies as Class II, BF & CF concerning electric shock. It is not proper to operate this Equipment around combustible anesthetic or dissolvent.
- Noise level is A class regarding IEC/EN 60601-1 and the subject of Nose is A level concerning IEC/EN60601-1-2.

Warning

Do not touch the patient while using the defibrillator. The user may be at risk.

When using the defibrillator, be careful about safety and use only the supplied cable.

Warning

In case the Equipment does not operate as usual or damaged, do not use on patient, and contact to the medical equipment technician of the hospital or the equipment supply division.

Equipment connection

Caution
<p>Doctors and patients in hospitals are exposed to the risk of uncontrollable currents. This current is caused by a potential difference between the equipment and a conductive object that can be contacted. Use auxiliary equipment to meet this requirement in accordance with EN60601-1; 2011.</p>

Biocompatibility

When used as intended, the parts of the product described in this operator manual, including accessories that come in contact with the patient during the intended use, fulfill the biocompatibility requirements of the applicable standards. If you have questions about this matter, please contact Bionet or its representatives.

Product Configuration

1. Main body of BM3 Monitor	1 EA
2. 3-Lead Patient Cable with extension cable	1EA
3. Disposable electrodes	10 EA
4. NIBP extension horse	1EA
5. Reusable Adult NIBP Cuff	1EA
6. SpO2 extension cable	1EA
7. Reusable Adult SpO2 Probe	1 EA
8. DC Adaptor (BPM050S18F02 made in Bridgepower Co., Ltd.)	1 EA
9. Operator`s Manual	1 EA
10. Thermal roll Paper	2 ROLL

Option Product

1. Reusable Temperature Probe (Surface/Skin, TEMPESENS-430)
2. Sidestream EtCO2 Module (Respironics)
3. Mainstream EtCO2 Module (Respironics)
4. Sidestream EtCO2 airway adapter sampling kit
5. Mainstream EtCO2 airway adapter
6. 5-Lead Patient Cable with extension cable

Warning

In order to avoid electrical shock, do not open the cover. Disassembling of the equipment should be done only by the service personnel authorized by Bionet

Warning

Users must pay attention on connection any auxiliary device via LAN port or nurse calling. Always consider about summation of leakage current, please check if the auxiliary device is qualified by IEC 60601-1, or consult your hospital biomedical engineer.

Basic Unit

Front view

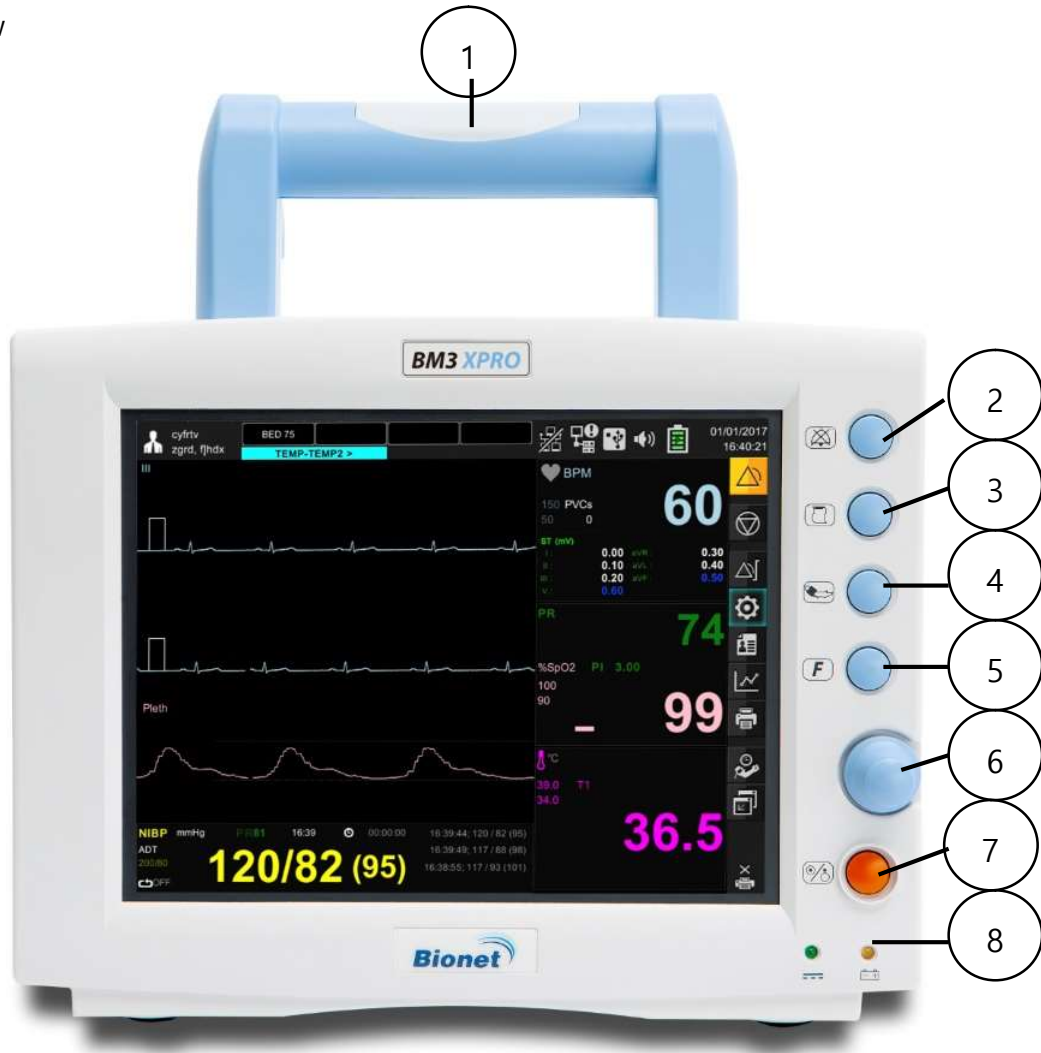

1	Alarm lamp handle	5	Home key
2	Alarm control key	6	Rotary knob key
3	Printer key	7	Power ON/OFF Key
4	Blood-pressure measurement key	8	Battery status indicator

Right side view

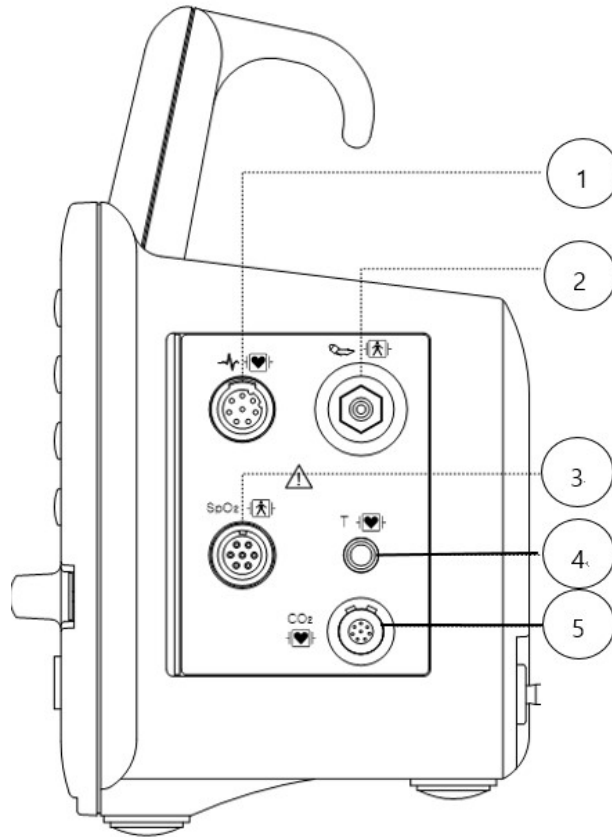

1	ECG connector
2	Blood pressure Hose connector
3	SpO2 connector
4	Temperature connector
5	EtCO2 connector

Left side view

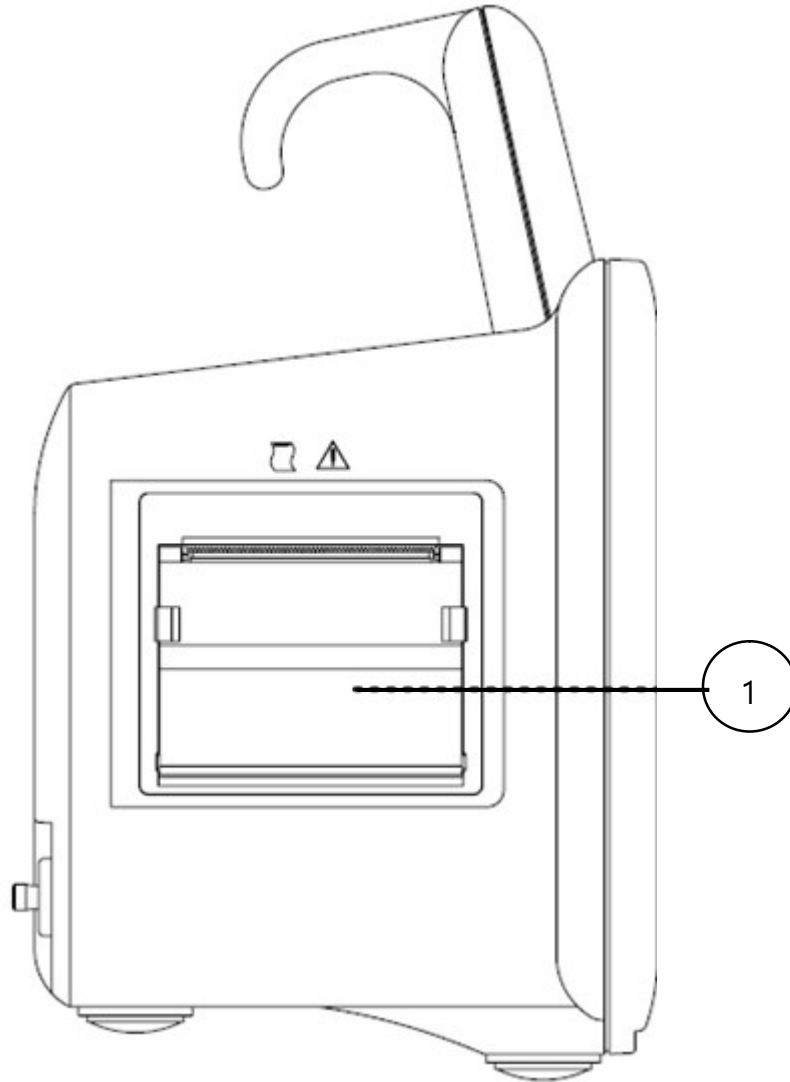

1	Printer
---	---------

Back side view

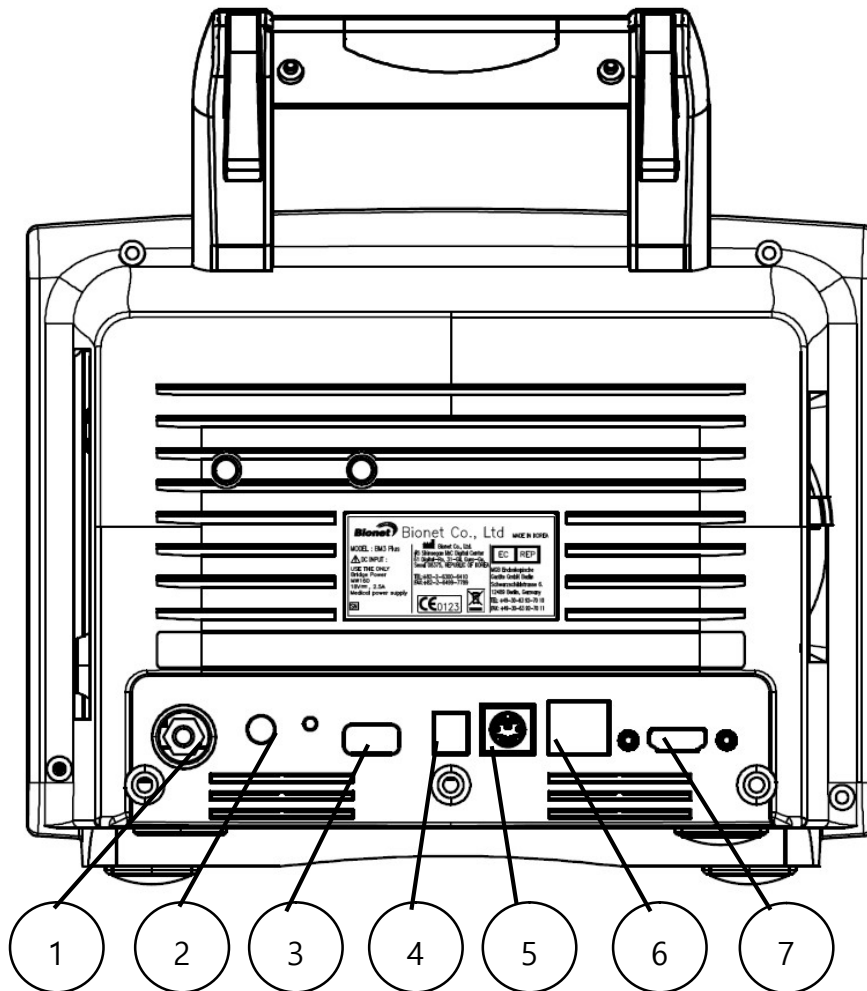

















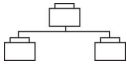



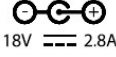

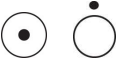
1	Potential equivalent
2	NURSE CALL connector
3	USB connector (USB 2.0 5Vdc / Max. 500mA),
4	DC input
5	Service port connector
6	Network connector
7	HDMI output

Warning

USB Compatible

- The BM3 is compatible with external USB memory drives up to 64GB.
- We recommend brands products listed in the manual (Sandisk, PNY, Transcend, Samsung).
- When using a product with high power consumption, such as an external hard drive, be sure to use the provided adapter for suitable power supply.(Cannot be used alone as a power supply)
- You should save the data of connected device before connecting the additional device.
- It may not be supported some devices that required high power.

Device Markings

	Caution : Consult accompanying documents		Ground terminal
	TYPE CF APPLIED PART		TYPE BF APPLIED PART
	Printer		Auxiliary Port
	LAN port		HDMI external port
	DC Input Indicator		USB port
	Battery Operation indicator		DC input connector
	Temperature		NIBP
	Power ON /OFF		Function
	WEEE(Waste Electrical and Electronic Equipment)		ECG
	European Medical Device Directive 93/42/EEC		Date of manufacture
	Consult instructions for use. This symbol advises the reader to consult the operating instructions for information needed for the proper use of the device.		Safety Sign : To signify that the instruction manual must be read. Reading the instruction manual before starting work or before operating equipment.
	Nurse call		Change the Alarm Mode
	IP(Ingress Protection)		

Power

The BM3 monitor uses a DC adapter (100-240 VAC / 18VDC 2.8A). In the event of a power outage or cable shortage, the monitor automatically switches to battery power to continue patient monitoring without data loss. The built-in battery is intended for back-up use only during power-off.

DC Product information

Manufacture: BRIDGEPOWER CORP.

Model name: BPM050S18F02

Input Power: 100~240V 1.2A

Output Power: 18 V, 2.8 A

DC Power LED is lighted on when the DC Power is plugged into the inlet at the back of the product. A press of power key makes the machine ready for use.

Caution

This equipment must be connected to a protective earth grounded power supply.

Using non-standard products other than the adapters supplied by us may cause signal distortion or noise. Be sure to use a genuine adapter that is supplied by our company and is insulated.

Battery power

DC adapter, it uses battery power when power failure and portable use.

The battery is attached to the bottom of the equipment and the additional extended battery is connected to the left side.







Battery: 031PpTC(3ICR19/65) (10.8V - 2150mA, Li-ion)

The Lithium-Ion battery is a rechargeable battery containing Lithium-Ion cells. Each battery contains an integrated electronic fuel gauge and a safety protection circuit.

Operation

1. Battery Power LED is lighted on when the machine is in use.
2. Battery is automatically charged when the machine is connected to DC Power Supply. The charging status is displayed at the top right of the screen
3. The charging status of the batteries is displayed with 5 green boxes, each indicating a different charging.(5% -> 25% -> 50% -> 75% -> 100%)
4. When discharging, the battery image is displayed in Red.

The monitor automatically turns off when the battery is depleted. The table below describes the function of the battery charging bar graph at the top of the screen.

Battery charge/discharge display		
Display	Charging remain time	Description
	Your battery is fully charging	Not applicable
	Your battery is fully charged	Not applicable
	Your battery is 75% charged	Not applicable
	Your battery is charged at 50%	If possible, connect it to the AC adapter.
	Your battery is charged at 25%	Immediately connect the monitor to the AC adapter.
	The internal battery is very low. (The power will turn off about 5min.)	Immediately connect the monitor to the AC adapter.
	There is no built-in battery.	Connect the battery.

Caution

The battery charge display is displayed correctly only when the battery is operating normally

Note

If no AC power is applied, the battery charge display will take up to 15 seconds to reflect the actual capacity of the internal battery.

Warning

Older or defective batteries will have significantly reduced capacity or operating time.

note

- To maximize the charge for transport, keep the monitor connected until you are ready to transport the patient. Reconnect the monitor immediately after transport.
- Bionet recommends replacing the lithium ion battery after 24 months of use.
- Battery life depends on usage. If battery life continues, battery life will decrease and frequency of replacement will increase.
- To prevent pre-discharge, recharge after the battery is discharged.

Caution

The battery charge display is accurate only when the battery is operating normally.

- Battery Charging Time: more than 6 hours

- Continuous Battery Usage Time: more than 3 hours for normal operation.(when fully charged)

Warning

Be careful of the polarity when replacing the battery.
We strongly recommend that you use the battery supplied by Bionet.
Using unauthorized batteries may damage the equipment

5. Presence of battery: When the battery is disconnected from the equipment and it malfunctions, it shows 'X' as shown below.



Note

Charging is not possible at low power (below 16V).
Cannot be used in vehicles with 24V power supply.
When replacing the battery, be sure to remove the DC adapter and replace it..

Warning

Older or defective batteries will have significantly reduced capacity or operating time.

How to replace the battery

Please assemble and replace as shown below.

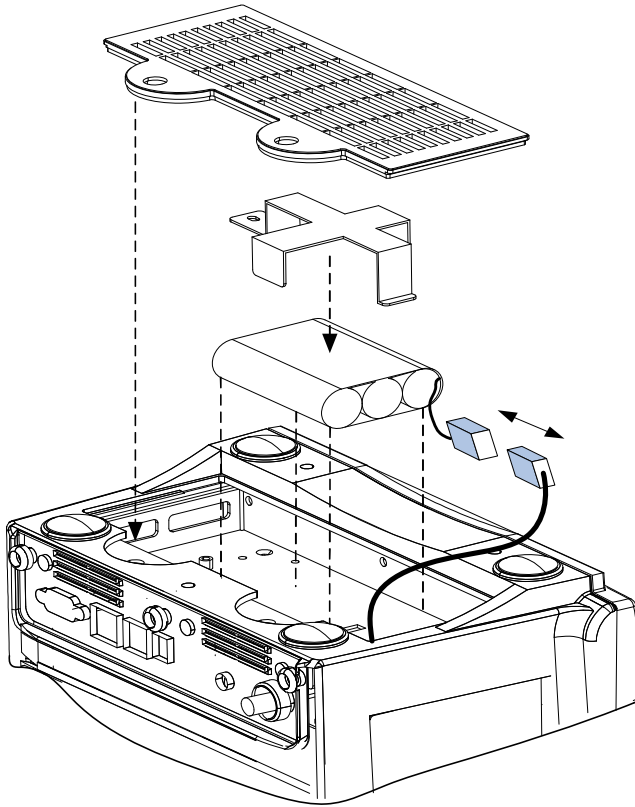

The Impact of Lithium-Ion Battery Technology on the Battery

The following are the key points you should know about Lithium-Ion battery technology:

The battery will discharge on its own, even when it is not installed in a monitor. This discharge is the result of the Lithium-Ion cells and the bias current required for the integrated electronics.

By the nature of Lithium-Ion cells, the battery will self-discharge.

The self-discharge rate doubles for every 10°C (18°F) rise in temperature.

The capacity loss of the battery degrades significantly at higher temperatures.

As the battery ages, the full-charge capacity of the battery will degrade and be permanently lost. As a result, the amount of charge that is stored and available for use is reduced.

Warning

When replace the battery, only use the battery provided by Bionet. Check the battery is properly secured to the bracket. Do not cause a serious impact on the battery.

Ignoring the above warnings will cause battery explosion and serious damage to devices.

Conditioning Guideline

The battery in the monitor full charged and discharged every six months and condition it using the battery charger.

Storage Guideline

Store the battery outside of the monitor at a temperature between 20°C to 25°C (68°F to 77°F).

When the battery is stored inside a monitor that is powered by an AC power source, the battery cell temperature increases by 15°C to 20°C (59°F to 68°F) above the room's ambient temperature.

This reduces the life of the battery.

When the battery is stored inside a monitor that is continuously powered by an AC power source and is not powered by battery on a regular basis, the life of the battery may be less than 12 months. Bionet recommends that you remove the battery and store it near the monitor until it is needed for transport.

How to Recycle the Battery

When the battery no longer holds a charge, it should be replaced. The battery is recyclables.

Remove the old battery from the monitor and follow your local recycling guidelines.

Warning

EXPLOSION HAZARD —

DO NOT incinerate the battery or store at high temperatures. Serious injury or death could result.

Getting Started

Starting the monitor:

Press the power key (O) at the bottom right of the monitor front panel. The power light on the monitor lights up, the alarm bar lights up, the power is turned off, the screen lights up, the main screen is displayed after running the self-test.

Stopping the monitor:

Press and hold the power key (O) for 3 seconds. The screen goes off.

Main screen setup

After the monitor is turned on, the main screen is displayed.

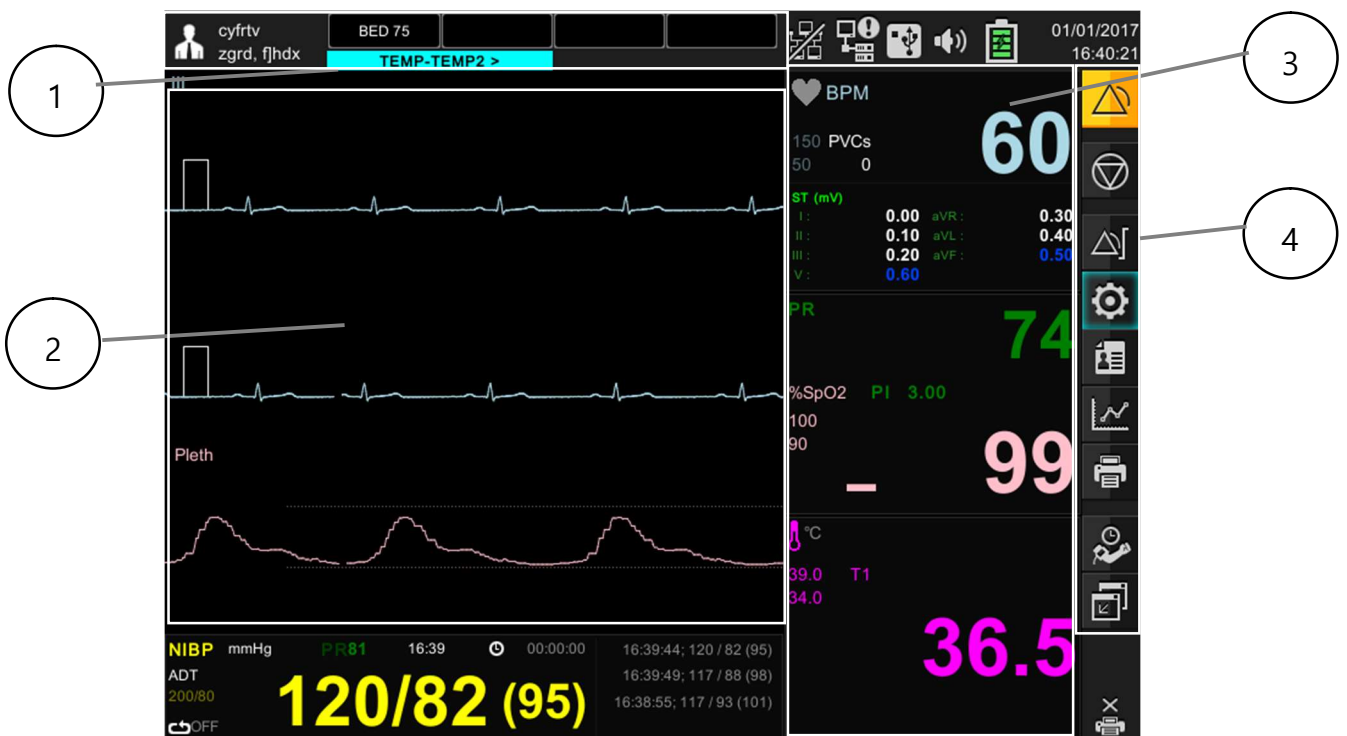

1	Status Message	3	Numeric Window
2	Waveform Window	4	Menu Window

The parameter box displays values, alarm limits and icons for the selected parameter. You can set the parameters and their associated waveforms so that they are easy to distinguish.

The message appears at the top of the screen. The patient name bed label is displayed in the upper left corner of the screen. The top right of the screen displays the time, network and device management status.





Using Rotary knob switch



The rotary knob switch allows the user to navigate menus, select settings, and perform menu functions. Rotate the rotary knob to move the menu item. To confirm the selection, press the rotary knob switch.











Fixed key

The fixed keys on the front panel of the monitor allow you to perform commonly performed functions.

Fixed key	Description	Fixed key	Description
	The alarm control key switches between Normal / Audio Paused and Alarm Paused mode. Press more than 3 seconds to switch to Audio Off or Alarm Off mode		Start or end non-invasive blood pressure (NIBP) measurements.
	Start or stop recording on time.		Return to the main screen or switch the extended parameter screen mode.

Function key

On the right side of the monitor's front panel, the touch screen icon on the touch screen allows you to perform frequently-used functions.

Fixed key	Description	Fixed key	Description
	Opens a table where you can set the maximum and minimum alarm limits.		This is an alarm mode key, so it enables to change Normal/ Audio Paused/ Alarm Paused mode.
	Access the Hospital / Emergency menu.		Displays the setup menu.
	Enable waveform stop function.		Displays the automatic blood pressure measurement interval setting menu.
	Displays the printer setup menu.		Displays trend menu.
	Displays the mini Trend window.		Set parameters in text screen.

2. SETUP

Overview

This chapter describes how to configure your monitor and how to upgrade your software.

Monitor configuration

Setup Menu tree

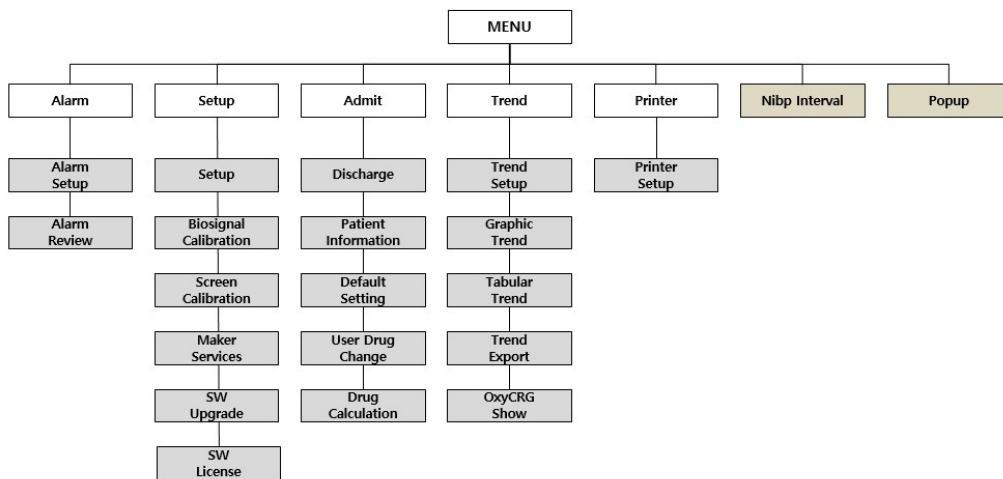

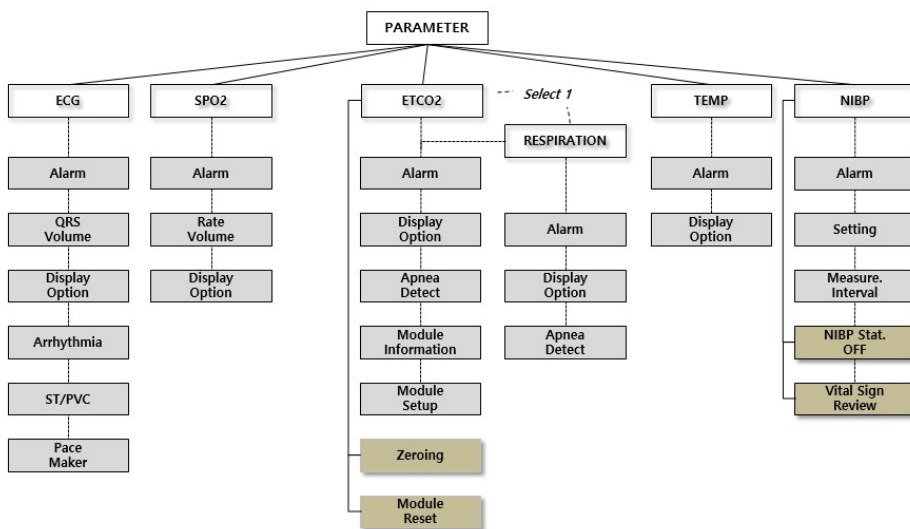

Parameter menu tree



Main menu setup

The Setup menu allows the user to access submenus, display screens, and perform specific monitor setup functions.

1. To display the Settings menu, click the Settings  icon to open the submenu.
2. Click the desired setting to access the submenu that performs the desired function or goes one step further down.
3. Click Close at the bottom of the submenu list to return to the previous menu or screen.

	Main menu	Sub menu
	A. SETUP	A-1. PARAMETER SETUP
		A-2. PARAMETER UNITS
		A-3. USER SERVICES
		A-4. SYSTEM INFORMATION
		A-5. NETWORK INFORMATION
		A-6. CENTRAL
		A-7. HL7
		A-8. ALARM SETUP
		A-9. DISPLAY OPTION
		A-10. HOSPITAL INFORMATION
	B. BIOSIGNAL CALIBRATION	B-1. ECG & RESP
		B-2. NIBP
	C. SCREEN CALIBRATION	
	D. MAKER SERVICE	D-1. MAC Address
	E. SW UPGRADE	
F. SW LICENSE		

A. SETUP menu		
MENU	Description	Available settings
A-1. PARAMETER SETUP	measurement on the monitor Parameter selection and color setting menu:ECG,SPO2,RESP,NIBP,TEMP, ETCO2	PARAMETER enable ON/OFF PARAMETER COLOR setup
A-2. PARAMETER UNITS	Unit setting menu used for monitor measurement	
A-2-1. Weight UNIT	Weight measurement unit	Kg Lbs
A-2-2. Height UNIT	Height measurement unit	Cm Inch
A-2-3. BLOOD PRESSURE UNIT	blood pressure measurement unit	mmHg kPa
A-2-4. ST UNIT	ST measurement unit	mm mV
A-2-5. TEMPERATURE UNIT	Temperature measurement unit	°C °F
A-2-6. GAS PRESSURE UNIT	Gas measurement unit	mmHg kPa vol%
A-2-7. MULTI GAS PRESSURE UNITS	Select whether to set the pressure unit for each gas type. When OFF, unit setting menu by gas type is displayed	ON / OFF
A-3. USER SERVICES	User configuration menu	
A-3-1. HOSPITAL UNIT	Set Monitor Environment Group	GENERAL ICU NICU OR CCU USER DEFINE

A-3-2. BED #	Set device number	1~300
A-3-3. KEY Sound	Set Key activation	ON / OFF
A-3-4. KEY Volume	Set Key sound	OFF ~ 100%
A-3-5. AC FILTER	Power filter settings	OFF, 50Hz, 60Hz
A-3-6. SCREEN BRIGHTNESS	Set screen brightness	10~100%
A-3-7. DATE DISPLAY	Set type of date display	ON / OFF
A-3-8. DEMO	Set Demo	ON / OFF
A-4. SYSTEM INFORMATION		
A-4-1. MAIN VERSION	Display main S/W version	
A-4-2.NIBP VERSION	Display NIBP Module version	
A-4-3.LANGUAGE	Set language	English, Korean French, Bulgarian Polish, German Chinese, Portuguese Hungarian, Czech Romanian, Italian Turkish, Spanish Russian, Greek Japanese
A-5.NETWORK INFORMATION		
A-5-1.WIRELESS	Wireless setup	ON/OFF
A-5-2.DHCP	Auto IP allocation setting menu	ON/OFF
A-5-3.DEVICE IP	IP setting menu	XXX.XXX.XXX.XXX
A-5-4.SUBNET MASK	SUBNET MASK setting menu	XXX.XXX.XXX.XXX
A-5-5.GATEWAY	GATEWAY setting menu	XXX.XXX.XXX.XXX
A-6.CENTRAL		
A-6-1. PROTOCOL Version	Network protocol menu	1.30

A-6-2. CENTRAL	Remote Communication menu	ON/OFF
A-6-3. Server IP	Remote PC IP address setting	XXX.XXX.XXX.XXX
A-7. HL7	HL7 Network message settings	
A-7-1. COM	Communication version	
A-7-2. Server IP	Remote PC IP address setup	XXX.XXX.XXX.XXX
A-7-3. PORT	Remote PC PORT address	XXXX
A-7-4. HL7 PERIOD	Transmission cycle settings menu	10sec, 30sec, 1,3,5,10,15,30min, 1 hour, 6 hour
A-7-5. HL7 NAK	NAK Transmission menu setup	ON/OFF
A-7-6. EDIT HL7 LABEL	Parameter label edit menu	
A-8. ALARM SETUP	Alarm settings menu	
A-8-1. ALARM PASSWORD	Alarm setup password activation menu	ON/OFF
A-8-2. SETUP PASSWORD	Password setup menu	
A-8-3. ALARM SOUND	Alarm sound type selection menu	IEC60601 BIONET
A-9. DISPLAY OPTION		
A-9-1. SWEEP SPEED (ECG/SPO2/RESP)		6.25 mm/sec, 12.5 mm/sec 25 mm/sec (basics), 50 mm/sec
A-9-2. SWEEP SPEED (RESP/ETCO2)		6.25 mm/sec, 12.5 mm/sec (basics), 25 mm/sec
A-10. HOSPITAL Information	Set Hospital information	
A-10-1. Name	Hospital Name	

A-10-2. Address 1	Address information 1	
A-10-3. Address 2	Address information 2	
A-10-4. Postal Code	Set postal Code	
B. BIOSIGNAL CALIBRATION	Set calibration menu	
B-1. ECG & RESP		
B-1-1. ECG Calibration	ECG calibration menu	10mm/mV input calibration display
B-1-2. RESP Calibration	RESP calibration menu	1ohm 1cmm display
B-2. NIBP		
B-2-1. ZERO Calibration	NIBP Zero calibration menu	Zero calibration menu at atmospheric pressure
B-2-2. Gain Calibration	NIBP Gain control menu	Perform 250mmHg pressure calibration and select menu
B-2-3. Pneumatic Pump	NIBP Pump control menu	ON/ OFF
B-2-4. Pneumatic Valve	NIBP valve control menu	Close /Open
C. SCREEN Calibration		Perform touch screen calibration point input
D. MAKER SERVICES		
D-1. MAC ADDRESS Editing		Enter a unique address for the device
D-2. SALSE COMPANY		BIONET OEM
E. SW Upgrade	Software Upgrade menu	
F. SW LICENSE	Software License menu	

Parameter color

Parameter	Basic color
Selectable colors	
Green, light blue, yellow, purple, blue, sky blue, orange, gray, light green, pink, white, red, light yellow	
ECG (ST)	Green
SpO2	Blue
RESP	Yellow
NIBP	Purple
TEMP	Green
ETCO2	Yellow

3. Network

Overview

When you connect the monitor to the network, you can access patient information from another monitor or central station connected to the network. These devices provide main screen information for remote viewing from each other.

BM Central connects the monitors to the central station and each device to provide various monitoring functions. The User Monitor's B2B View (Bed to Bed View) feature allows the user to view other monitor screens connected to the network and to silence remote control and alarms[Audio Paused].

With the Remote Control feature in BM Central, you can perform the following tasks on a patient monitor that can be remotely controlled from a central station.

- Start recording
- Modify alarm limit
- Alarm Mute
- Print the current monitor screen to a network laser printer (Using the optional remote keypad)
- Enter, edit and view patient data

Network connection

In a network, data can be exchanged over wired or wireless technology. All data interfaces (e.g. RS-232, LAN, USB interface) described in the standard and convention can be network. This device can exchange information with other devices through the network during operation and supports the following functions.

- Display waveform and parameter data
- Alarm signal
- Remote control (e.g. alarm management)
- Device setup and transmission of patient data

Connecting this device to an integrated network with other devices, or subsequent changes to that network, can be a new risk to patients, users, and third parties. These risks must be identified,

analyzed and evaluated before the device is connected to the network or the network is changed, and appropriate action must be taken.

Subsequent changes to the network example:

- Network configuration change
- Removing a device from the network
- Adding new devices to the network
- Upgrading or updating devices connected to the network

Warning
<p>Recommendations for wireless connections</p> <ul style="list-style-type: none">• BM3 has a change in the number of equipment connections depending on wireless AP (Access Point) performance.• When using a general AP, it is recommended to connect 8 units to the same network.• Due to the nature of wireless, connectivity may not be good depending on the environment

Remote View

If the monitor is connected to a network, you can view other monitors connected to the network on your monitor and make the alarm silent. The procedure for displaying the remote view screen is as follows. To set the menu display time, refer to the setting page below.

NOTE: The Print Screen Sticky key on the front panel of the monitor allows you to print the remote view screen as it appears on your local monitor.

The menu below is a setup menu for retrieving data from other patient monitoring devices connected to the same network. To view the menu settings, touch the My BED number box in the top menu bar.



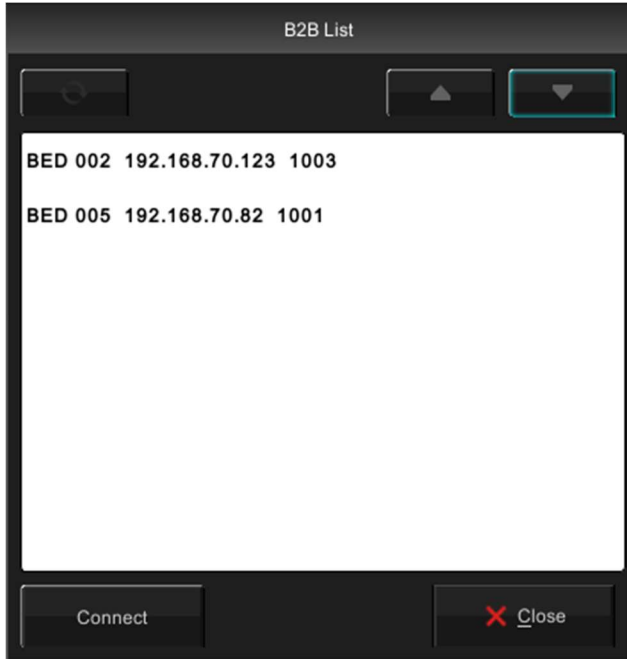

MENU	Description	Available Settings
B2B VIEW MONITOR LIST sub menu		
REFRESH	Menu to update monitor list connected to network	
UP	Move to upper list	
DOWN	Move to lower list	
MONITOR LIST	List of monitor information connected to the network	
CONNECT	Monitor connection menu for remote connection	

Display Mode

Wave and Numeric Mode

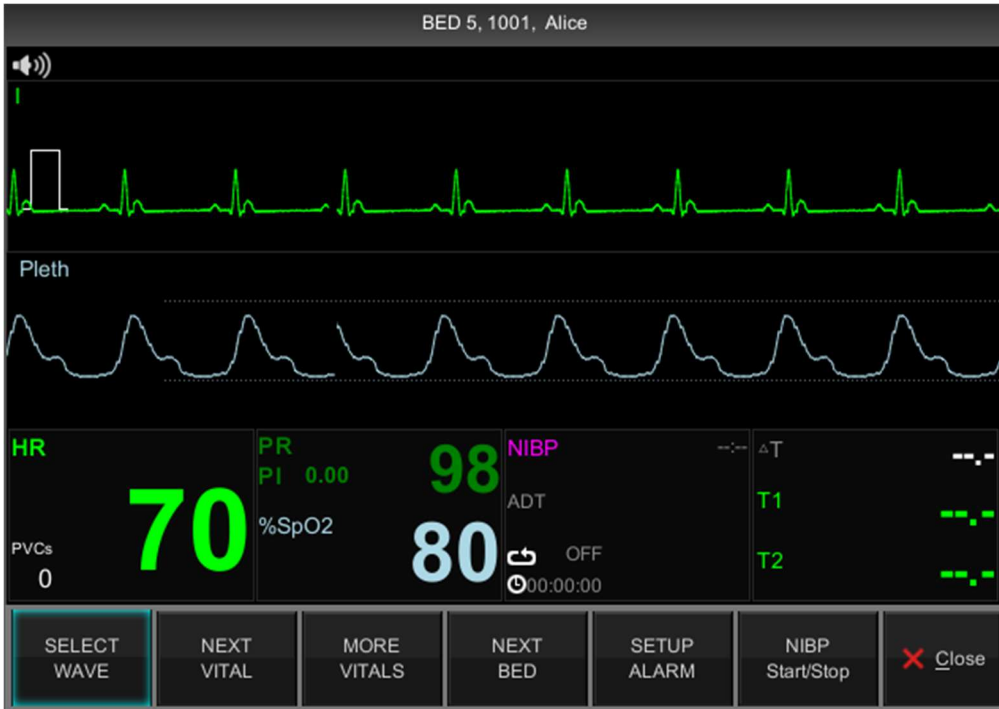

Numeric Mode

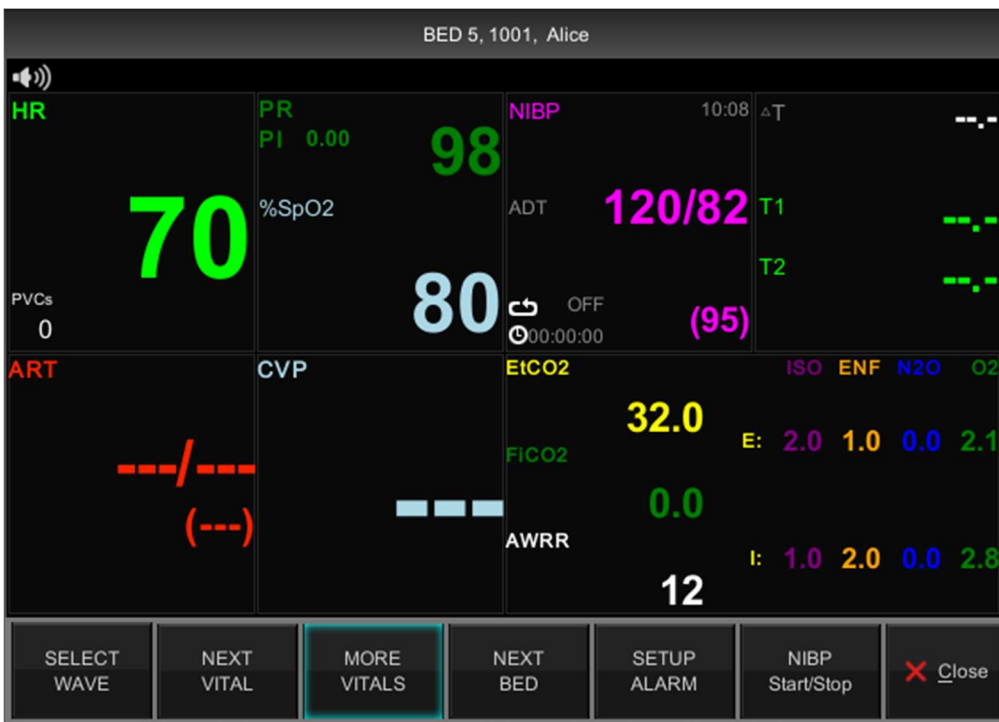

MENU	Description	Available settings
A-1 SELECT WAVE	Waveform selection menu to view	
A-1-1. TRACE I	The waveform selection menu for TRACE I in the B2B View window	ECG, SPO2, RESP,ETCO2,
A-1-2. TRACE II	The waveform selection menu for TRACE II in the B2B View window	ECG, SPO2, RESP,ETCO2
A-2 NEXT VITAL	Additional parameter selection menu	
A-3 MORE VITALS	WAVE screen and TEXT screen selection menu	
A-4 NEXT BED	Connect to the following connected monitor devices	
A-5 SETUP ALARM	Alarm setting menu of remotely connected monitor	Normal Audio Paused Alarm Paused Audio Off Alarm Off
A-6 NIBP START/STOP	NIBP measurement start and stop menu	START STOP
A-7 CLOSE	Remote viewer close menu	

4. Admission and Discharge

Overview

The Patient admit menu allows you to enter and edit a patient's personal data (name, ID, Birthday, Height, Weight). If your monitor is operating in a network monitoring, you can also review or change the monitor's care unit and bed label assignments.

Patient data and trends can also be transferred to PC. The transfer procedure depends on whether the Inbound and Outbound monitors are connected to the Central network.

Patient admission

How to admit a patient:



1. Press the **Patient icon** button.
2. Click on **Admit**.
3. Click on **Patient Information**.
4. Please select a field. The data entry screen appears.
5. Click the letter of the word you want to input.
If you made a mistake, click Backspace and try again.
6. Click **↵ Enter** to confirm your entry.
7. Click on the next field and repeat steps 5 and 6.

Note:

- To change a patient's classification (adult, pediatric or neonate), access the patient settings menu.
- Additional settings (Gestational Age) are available for neonate mode.

Patient discharge







The patient should be discharged before the other patient is admitted. Otherwise The monitor attaches the existing data to the patient in the back of the hospital.

How to discharge a patient:

1. Press the **Discharge. fixed key.**
2. When you execute the discharging menu on the screen, you will be warned that all patient data will be deleted.
3. Press the **Accept button.** The discharge procedure is in progress.

The monitor displays a Discharge message. When the patient is successfully discharged, a banner with the following message is displayed.

PATIENT TYPE: When you set the animal type, type image is displayed on the upper left corner

TYPE	Male Admit	Female Admit	Discharge
ADULT			
PEDIATRIC			
NEONATE			

	Main menu	Sub menu
	A. Admit / <u>D</u> ischarge	
	B. Patient Information	B-1. Patient Information
	C. Default Setting	
	D. User Drug Change	
	E. Drug Calculation	E-1. Setting E-2. Titration Table
MENU	Description	Available Settings
A. Admit / Discharge	Admission and discharge setting	
B. Patient Information		
B-1. Patient Information		
B-1-1. Patient Type	Patient Type setting	ADULT, PEDIATRIC, NEONATE
B-1-2. ID	Patient ID setting	
B-1-3. First Name	First Name setting	
B-1-4. Last Name	Last Name setting	
B-1-5. Gender	Gender setup	MALE , FEMALE
B-1-6. Birthday	Birthday setting menu	YYYY/MM/DD
B-1-7. Weight	Age setting	XXX.XX Kg
B-1-8. Height	Weight setting	XXX.XX Cm
B-1-9. Blood Type	Default setting	A Rh+/ Rh-/-D-/ Rh Null B Rh+/ Rh-/-D-/ Rh Null O Rh+/ Rh-/-D-/ Rh Null AB Rh+/ Rh-/-D-/ Rh Null Unknown
C. Default Setting	Set Patient Info to Default Value.	
D. User Drug Change		
D-1. DRUG TYPE	Set Drug Type of Patient.	DRUG-1~5
D-2. DRUG NAME	Set Name of Drug	
D-3. DRUG UNIT	Choose the Unit of Drug	mg/hr, mg/min, mg/kg/hr mg/kg/min, mcg/hr, IU/hr, mcg/min, mcg/kg/hr, mcg/kg/min, units/hr
E. Drug Calculation		
E-1. Setting		

E-1-1. DRUG TYPE	Choose Drug Type in the List(21)	AMINOPHYLLINE TPA BRETYLIUM LIDOCAINE PROCAINAMIDE EPINEPHRINE LEVOPHED ISOPROTERENOL DOPAMINE DOBUTAMINE NITROGLYCERINE NITROPRUSSIDE INOCOR HEPARIN INSULIN STREPTOKINASE DRUG-1~5
E-1-2. Drug Quantity	Set Drug Quantity	
E-1-3 Solution Volume		
E-1-4. Dose Quantity	Set Dose Quantity	
E-1-5. Inflation Rate		
E-1-6. Weight		Some drugs may not be supported
E-1-7. Dose Step		
E-2. Titration Table		
E-2-1. DRUG NAME	Set Drug Name	
E-2-2. DRUG QUANTITY	Set Drug Name	Refer to drug list bellow.
E-2-3. SOLUTION VOLUMNE		
E-2-4. Dose Quantity		Refer to drug list bellow.

E-2-5. Inflation Rate		Refer to drug list bellow.
E-2-6. WEIGHT		Refer to drug list bellow.
E-2-7. DOSE STEP		Refer to drug list bellow.

The table shows the formula for calculating the dosage of drugs below.

Unit	NameUnit	Equation
mg/hr	AMINOPHYLLINE TPA	$\text{Flow rate(ml/hr)} = \frac{\text{Dose(mg/hr)} \times \text{SolutionVolume(ml)}}{\text{Drug QTY(mg)}}$
mg/min	BRETYLIUM LIDOCAINE PROCAINAMIDE	$\text{Flow rate(ml/hr)} = \frac{\text{Dose(mg/min)} \times \text{SolutionVolume(ml)} \times 60}{\text{Drug QTY (mg)}}$
mcg/min	EPINEPHRINE LEVOPHED ISOPROTERENOL	$\text{Flow rate(ml/hr)} = \frac{\text{Dose(mcg/min)} \times \text{SolutionVolume(ml)} \times 60}{\text{Drug QTY (mg)} \times 1000}$
Mcg/kg/min	DOPAMINE DOBUTAMINE NITROGLYCERINE NITROPRUSSIDE INOCOR	$\text{Flow rate(ml/hr)} = \frac{\text{Dose(mcg/kg/min)} \times \text{Weight(kg)} \times \text{SolutionVolume(ml)} \times 60}{\text{Drug QTY (mg)} \times 1000}$
units/hr	HEPARIN INSULIN	$\text{Flow rate(ml/hr)} = \frac{\text{Dose(units/hr)} \times \text{SolutionVolume(ml)}}{\text{Drug QTY(units)}}$
IU/hr	STREPTOKINASE	$\text{Flow rate(ml/hr)} = \frac{\text{Dose(IU/hr)} \times \text{SolutionVolume(ml)}}{\text{Drug QTY (IU)}}$

Shows each unit setting range.

Dose		Drug QTY	
Unit	Proper Range	Unit	Proper Range
mg/hr	0.01 to 500	mg	0.01 to 2000
mg/min			
mg/kg/hr			
mg/kg/min			
mcg/hr			
mcg/min			
mcg/kg/hr			
mcg/kg/min			
units/hr	10 to 15000	Units	100 to 150000
IU/hr	1000 to 1500000	IU	1000 to 1500000

Items	Unit	Drug QTY unit
Volume of Liquid	mL	1 to 1000
WEIGHT	Kg	0 to 300
Velocity of Flow	ml/hr	0.1 to 600

Registration of patient ID using barcode

This product can input the PATIENT ID in barcode format to the device using USB barcode scanner. First, connect the barcode scanner to the USB HOST connector on the left as shown in the figure below. After the BEEP sound is generated, the barcode icon () appears at the bottom of the instrument screen.

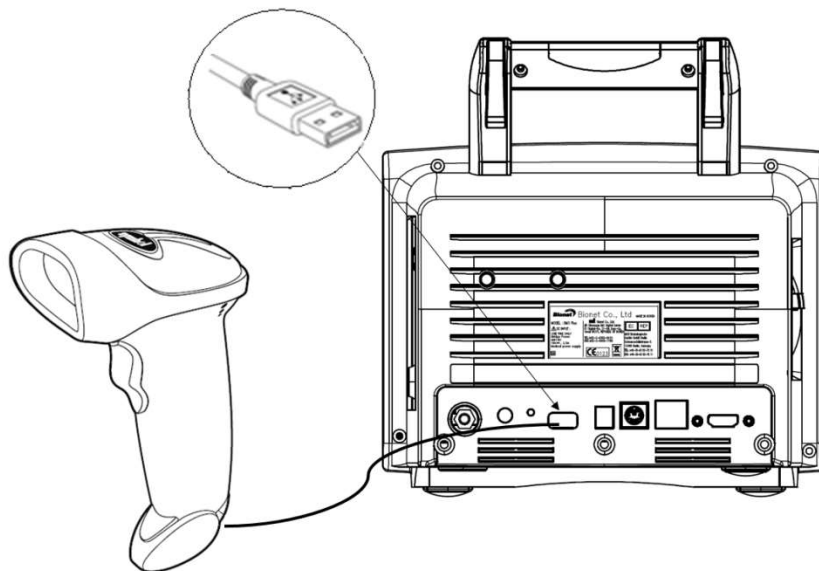
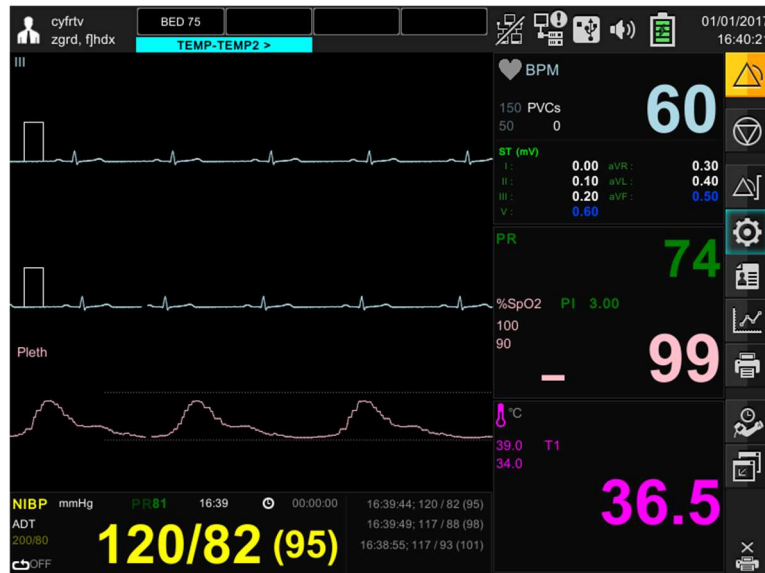

The barcode that you want to input is matched to the index LED generated by the scanner, and if you press the input button, the corresponding ID is read and sent to the equipment. The sender ID is displayed at the top center of the screen.

5. Alarm

Overview

The monitor displays the alarm limit (parameter threshold) and can be configured by the user to raise an alarm if exceeded. Limits are displayed both in the alarm limits table and in the parameter box. If this limit is exceeded, a visual or audible alarm will occur.

The bedside monitor is the primary alarm device, and there may be other secondary alarm devices depending on how you configured the device / network. Depending on the alarm condition, the monitor generates an alarm using one or more of the following devices:

- Hearing sound reflecting alarm severity
- Change the color in the parameter box of the alarm parameter
- Alarm messages in the local message area
- Alarm banner indicating alarm status
- External alarm device such as nurse call system
- Activate alarm recording

The monitor generates an alarm when the parameter in the Alarm Limits table is **ON**. It is not a prerequisite that the parameter is displayed on the display or connected in the event of an alarm.

Alarm priority











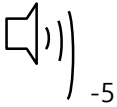

The alarm type is divided into a patient status alarm and a product status alarm.

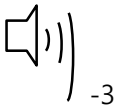
The patient status alarm sounds when the diagnostic function (ECG 3 auto diagnosis) and alarm upper and lower limits are exceeded, and there are levels of HIGH, MEDIUM, LOW and MESSAGE, and there is a difference in the order and volume of the alarm.

You can set the alarm level for each parameter and function.

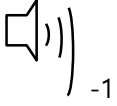
The patient status alarm provides the highest priority alarm.

The features of each alarm are described as follows. The alarm priority is HIGH > MEDIUM > LOW > MESSAGE. For alarms over MEDIUM, the printer output is supported when ARM RM PRINT ON is set.

Alarm priority	Alarm sound	Alarm Color	Alarm printer	Alarm lamp
HIGH	 -5			 2.0 Times/Sec Blinking
MEDIUM	 -3			 0.5 Times/Sec Blinking
LOW	 -1			 Non Blinking
MESSAGE				



: Alarm sounds



: Red Lamp is turned on.



: Waves are printed out

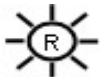

: Red color alarm indicator on the screen is blinked



: Yellow color alarm indicator on the screen is blinked



: Blue color alarm indicator on the screen is displayed

Audible alarm		
Alarm priority	BIONET	IEC
HIGH	Two consecutive square beeps	Beep 5 times Short stop time 5 beeps, 5 beeps
MEDIUM	Stop after two short beeps.	3 short beeps Short stop time, 15second pauses
LOW	Low sound 30 times per second	Two beep for 30seconds

Alarm management

You can use the lock key on the front of the monitor to hold the alarm.

To change Alarm Mode: A short press of the alarm control key circulates through the Normal / Audio_Paused / Alarm_Paused alarm modes. Press and hold the key for more than 3 seconds to switch to Alarm_Off / Audio_Off mode using the mode selection dialog regardless of which alarm mode the monitor is currently in

Audio_Paused: Stop the audible alarm for 1 minute but the visual alarm is activated still. Banner with the message Audio Paused and countdown timer are displayed on the screen. After the user switches to another alarm mode or after the timeout period has elapsed if the alarm occurs still, visual and audible alarms will be activated again

Alarm_Paused: Stop visual and audible alarms during user defined time. Banner with the message Alarm Paused and countdown timer are displayed on the screen. After the user switches to another alarm mode or after the timeout period has elapsed if the alarm occurs still, visual and audible alarms will be activated again

Alarm_Off: Stop visual and audible alarms. A banner with the message Alarm Off is displayed on the screen. The monitor maintains Alarm Off mode until user switch to another alarm mode.

Audio_Off: Stop the audible alarm. A banner with the message Audio Off is displayed on the screen. The monitor maintains Audio Off mode until user switch to another alarm mode

Alarm control:

Various alarm functions, such as alarm hold, validity and alarm limit indicators, can only be configured in the alarm control menu, accessible only through the password protected unit manager menu.

Nurse call:

If the monitor is sounding an alarm, the nurse call system is signaling.

When an audible alarm is silenced (Audio Paused or Audio Off) at the bedside unit, the nurse call system will not alarm.

Your system administrator can change the alarm priority level for the nurse call signal.

if the priority level is set to **High** , only high-priority alarms will sound on the nurse call system.

Note

- Audio Paused and Audio Off modes only stop the audible alarm sound and touch or key sound is activated always.
- To adjust the Touch or Key Sound, use the Key Sound menu in Setup.

Alarm settings

	Main menu	Sub menu
	A. Alarm Setup	A-1. Parameter Alarm Limit
		A-2. Arrhythmia Alarm Condition
		A-3. System Alarm Condition
		A-4. Alarm Parameter
		A-5. Nurse Call
	B. Alarm Review	

MENU	Description	Available Settings
A. Alarm Setup menu		
A-1. Parameter Alarm Limit	All parameter alarm, level, activate Setup menu	
A-2. Arrhythmia Alarm Condition	Arrhythmia alarm level setting menu ASYSTOL, VTAC, VTAC /VFIB,	
A-3. SYSTEM ALARM CONDITION	System alarm level setting menu LOW BATTERY	
A-4. Alarm Parameter	Alarm Settings menu	
A-4-1. Alarm Volume	The volume can be changed from OFF	10~ 100%

	to 10% to 100%.	
A-4-2. Alarm Pause Time	No sound for 5minutes, Release on alarm again	1,2,3,5,10,15min
A-5. Nurse call	User Settings menu.	
A-5-1. Nurse call on Alarm	NURSE CALL function ON / OFF; After setting ON, check if relay sound is heard in ALARM situation.	ON/OFF
A-5-2. Call Type	NORMAL CLOSE / NORMAL OPEN; ACTIVE state change check	Normal open Normal close
A-5-3. Duration	ONE TIME / CONTINUE / CYCLING	One time Continue Cycling
A-5-4. Level		Message/ Low/ Medium/High

Alarm event

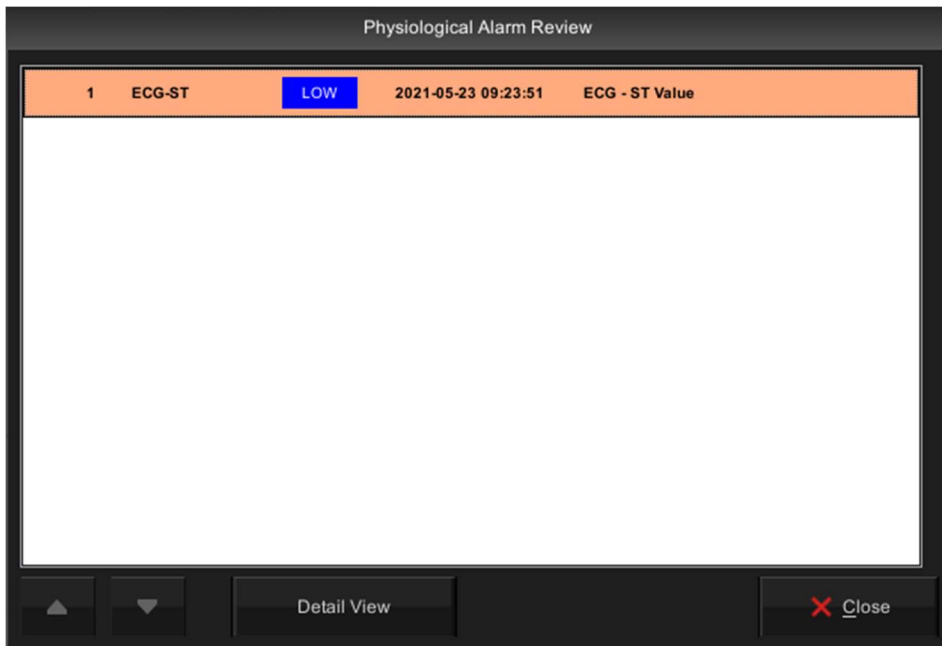

6. TREND

Overview

The monitor stores trend data for all connected signals. Users can request trend recording and can also print the screen of trends displayed.

Triggered alarm events are displayed in red inverted triangles on the Event List and Timeline

Trend setup

	Main menu	Sub menu
	A. Trend Setup	A-1. Popup Trend
	B. Graphic Trend	B-1. Graphic Trend
		B-2. Tabular Trend
	C. Tabular Trend	C-1. Graphic Trend
		C-2. Tabular Trend
	D. Trend Export	
E. OxyCRG Show/Hide		

MENU	Description	Available settings
A. Trend Setup menu		
A-1. Popup Trend		
A-1-1. Time Period	Show time interval setting menu	30min, 60min, 90min, 3hour, 6hour
A-1-2. Configure Parameters		
B. Graphic Trend menu		
B-1. Graphic Trend		
B-1-1. Event List		
B-1-2. Time Period	Saved data can be viewed graphically in sections.	30min, 60min, 90min, 2hour, 3hour, 4hour, 6hour, 8hour, 12hour
B-1-3. Display Group		
B-1-4. Print	Set the time and see the stored values at each set time.	
B-2. Tabular Trend		
B-2-1. Event List		
B-2-2. Time Period	Time period setting	1min, 5min, 10min, 15min, 30min, 1hour, 2hour
B-2-3. Display Group		
B-2-4. Print	Graphic trend print output	
C. Tabular Trend menu		
C-1. Tabular Trend		

C-1-1. Event List		
C-1-2. Time Period	Time period setting	1min, 5min, 10min, 15min, 30min, 1hour, 2hour
C-1-3. Display Group		
C-1-4. Print	Tabular trend print output	
C-2. Graphic Trend		
C-2-1. Event List		
C-2-2. Time Period	Time period setting	30min, 60min, 90min, 2hour, 3hour, 4hour, 6hour, 8hour, 12hour
C-2-3. Display Group		
C-2-4. Print	Graphic trend print output	
D. Trend Export menu		
D-1. Start Time	Parameter save start time setting menu	hh:mm
D-2. End Time	Parameter Save Last Time Setting Menu	hh:mm
D-3. Export Time Period	Time period setting	1min, 5min, 10min, 15min, 30min, 1hour
D-4. Export Order	Sequence of parameters	Descending Ascending
D-5. Export		
F. OxyCRG Show/Hide menu	When selected, the screen shows heart rate, breathing, and oxygen saturation trends. It is not displayed in single parameter mode or 7ch ECG screen.	SHOW HIDE

Graphical trend

Trend graph shows saved trend data as individual graph type for each parameter. These graphs show that the displayed parameters are active over a significant period of time Shows five channels at a time. Confirmation color and scale Meter labels and numbers are displayed on the left side of the trend channel. Vertical lines in each graph. This displays the time distribution. Trends keeps the most up-to-date data. It is automatically updated on the right side of the graph.

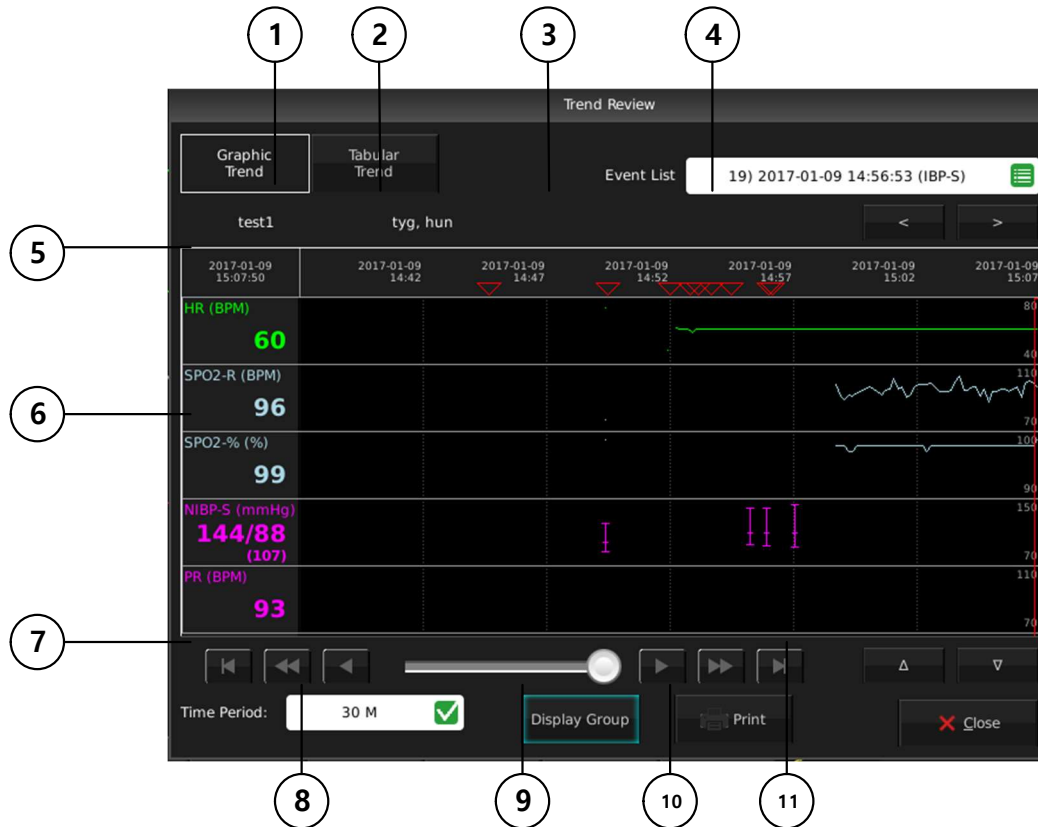

①	Graphic trend select menu
②	Tabular trend select menu
③	Event list menu
④	Event previous/next menu
⑤	Patient ID
⑥	Parameter numeric window
⑦	Interval search window
⑧	Trend interval setup menu

⑨	Parameter selection menu to show
⑩	Printer menu
⑪	Parameter window selection menu

Tabular trend

The Trends table displays the trend data in an easy-to-read table format. Up to six are displayed, updated every minute. The time stamp above each column indicates the interval at which the data in that column was trended. The value displayed is the last one acquired during the interval, and the most recent data is displayed in the rightmost column.



①	Graphic trend select menu
②	Tabular trend select menu
③	Event list menu
④	Event previous/next menu

⑤	Patient ID
⑥	Numeric Parameter window
⑦	Selection Navigation window
⑧	Trend interval setting menu
⑨	Parameter selection menu
⑩	Printer menu
⑪	Parameter select window menu

File export

The file extract function can transfer trend to a file using USB memory.

- ① Confirm USB memory connection.
- ② Press TREND > Trend Export button.
- ③ Set a start time, end time, export time period, and export order.
- ④ Press Export button
- ⑤ The data is transferred to USB memory. A completion message is displayed when the transmission is completed.

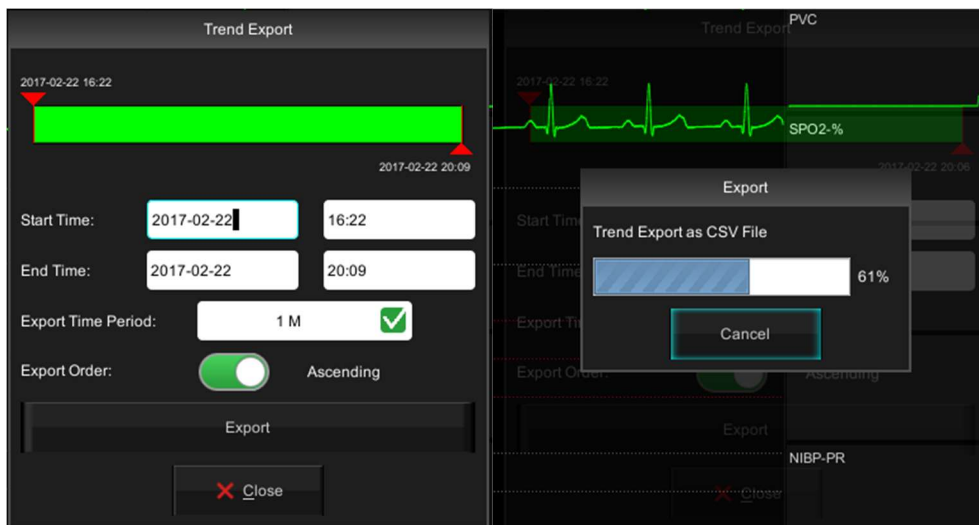

Warning

USB Compatible

- The BM3 is compatible with external USB memory drives up to 64GB.
- We recommend brands products listed in the manual (Sandisk, PNY, Transcend, Samsung).
- When using a product with high power consumption, such as an external hard drive, be sure to use the provided adapter for suitable power supply.(Cannot be used alone as a power supply)
- You should save the data of connected device before connecting the additional device.
- It may not be supported some devices that required high power.

Note

Saving Patient Data to a USB

- Exported patient data on a USB memory drive is not encrypted and therefore raises privacy concerns. So, only authorized personnel should be allowed to view, handle, store or transmit patient data.
- The file format of the USB memory drive used for the BM7 patient monitoring device is FAT32.

Popup trend

The user can continue to monitor the main screen waveform and parameter box while displaying trend data for up to 5 parameters for up to 6 hours. The pop-up trend graph follows the display order indicated by each parameter in the trend setup and is updated with new trend data every 60seconds. When selecting pop-up trend, you can switch to ST analysis window and double-zoom mode.

If there is no parameter set in Trend setup> Configure parameters, only ST analysis window is displayed.

To change the popup menu window, touch the top and bottom of the popup menu with the touch key, or select it with the rotary switch.

Popup trend window

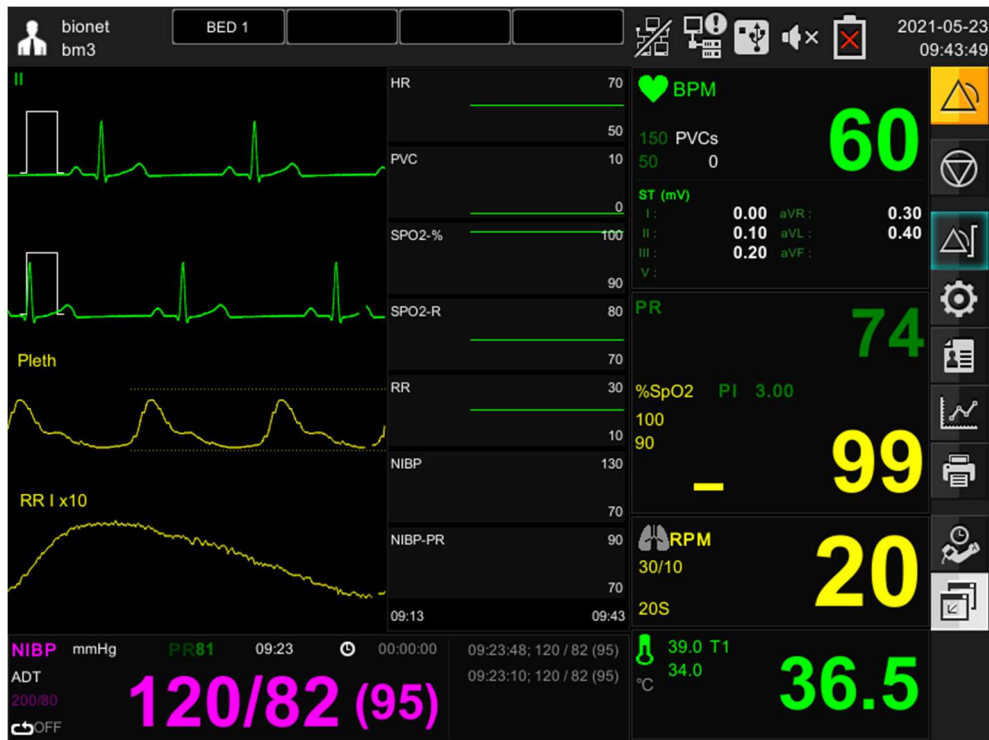

Popup ST window

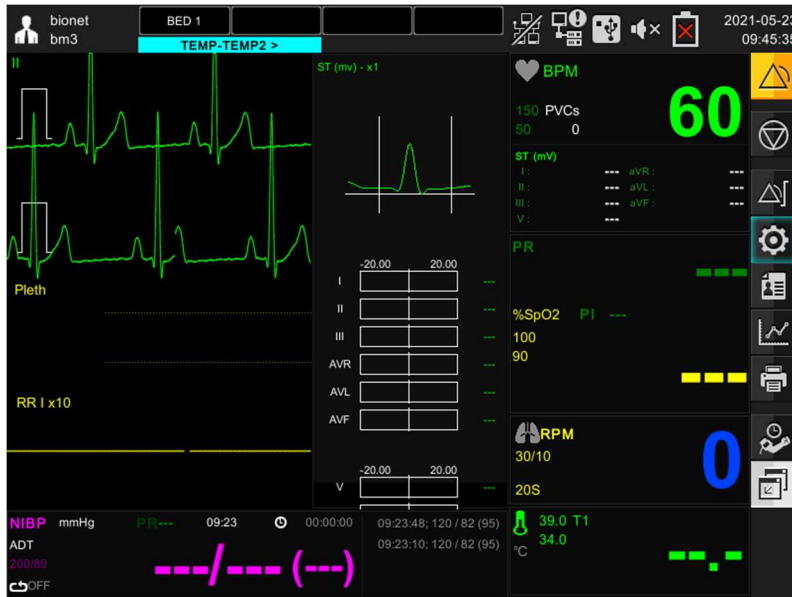

Popup enlarge trend window

You can change the size of the popup menu by pressing and releasing the center of the popup menu for at least 1second.

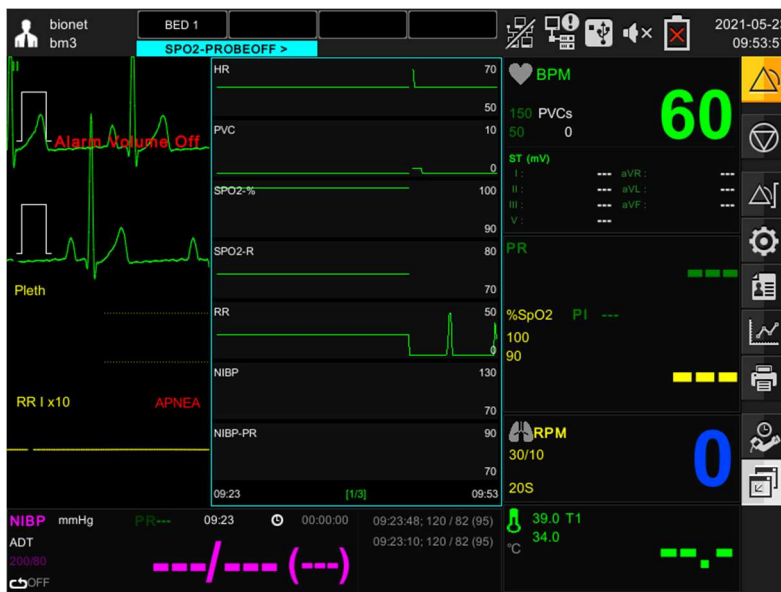

7. ECG

Overview

The monitor can calculate heart rate, detect arrhythmia (adult and pediatric patients), and display ECG data. The electrocardiogram screen provides 1 channel display. It calculates the heart rate by detecting the electrocardiogram signal of the patient and alarms according to the set upper and lower limit of alarm.

ECG connector position and measurement cable

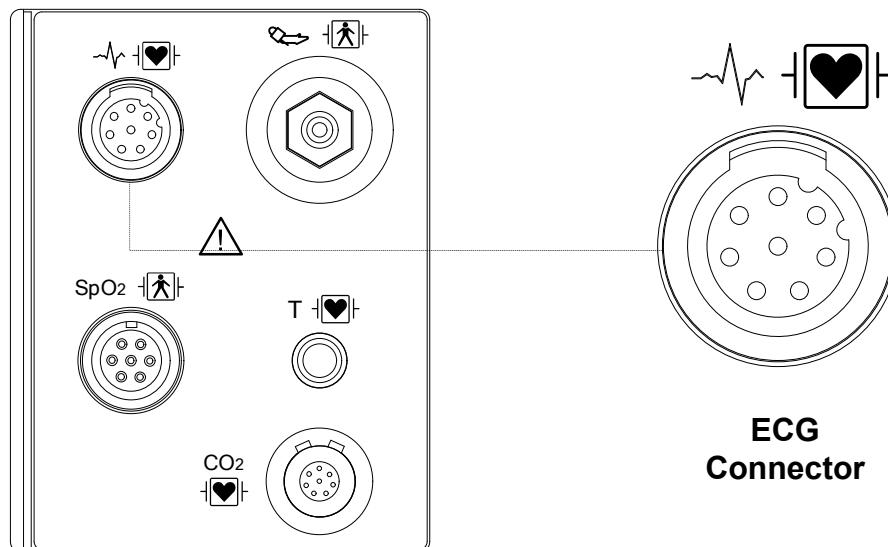

Electrode placement

1. If you have a lot of hair, shave. With alcohol-soaked cotton, wipe the patient's skin to attach the electrode. Avoid wrinkled or uneven skin, and wipe off alcohol with a dry cotton towel.
2. Unpack the electrode package and remove the electrode
3. Remove the rear mounting surface of the electrode. Be careful not to touch the adhesive side.
4. Attach disposable electrodes to the previously sterilized skin.

5. Connect the lead of the electrode and the wire of the monitor
6. Fix the electrode to the skin, and secure the cable with the remaining length between the instrument and the electrode with surgical tape. This fixation prevents the electrode from moving.

Note

- Make sure that the contact area of the disposable electrode is not dry to maintain a good connection between the electrode and the skin.
- If you suspect that the disposable electrode is in poor contact, replace it immediately with a new electrode. Otherwise, the contact impedance of the skin and electrode will increase, and the correct ECG signal will not be obtained.
- If the contact condition gets worse before expiration date on the packaging, replace with a new one.
- To get a stable ECG waveform, rub the skin with gel or benzoin tincture.

ECG Precaution

Caution

- Use caution when using evoked potential equipment as it may interfere with ECG monitoring.
- Do not rely solely on ECG for patients with epileptic tendencies. Electrical disturbances of non-cardiac circles such as seizures may interfere with the detection of specific arrhythmias.

Warning

CABLES — Route all cables away from patient's throat to avoid possible strangulation.

CONDUCTIVE CONNECTIONS — Extreme care must be exercised when applying medical electrical equipment. Many parts of the human/machine circuit are conductive, such as the patient, connectors, electrodes, transducers. It is very important that these conductive parts

do not come into contact with other grounded, conductive parts when connected to the isolated patient input of the device. Such contact would bridge the patient's isolation and cancel the protection provided by the isolated input. In particular, there must be no contact of the neutral electrode and ground.

DEFIBRILLATION — Do not come into contact with patients during defibrillation. Otherwise serious injury or death could result.

To avoid the risk of serious electrical burn, shock, or other injury during defibrillation, all persons must keep clear of the bed and must not touch the patient or any equipment connected to the patient.

After defibrillation, the screen display recovers within 10seconds if the correct electrodes are used and applied in accordance with the manufacturer's instructions.

Patient cables can be damaged when connected to a patient during defibrillation. Check cables for functionality before using them again.

The peak of the synchronized defibrillator discharge should be delivered within 60ms of the peak of the R wave. The signal at the ECG output on the patient monitors is delayed by a maximum of 30ms.

If the ECG waveform on the screen is too unstable to synchronize with the patient's heart beat because of the following reason, remove the cause of an alarm, message, or unstable ECG, and then use a stable ECG lead for synchronization.

- ✓ ECG electrode is detached or broken. Lead wire is detached or broken.
- ✓ Lead wire moves. AC interference, EMG noise or noise from ESU is superimposed.
- ✓ Connection cable is broken or has a short circuit. Connector has poor contact.

INTERFACING OTHER EQUIPMENT — Devices may only be interconnected with each other or to parts of the system when it has been determined by qualified biomedical engineering personnel that there is no danger to the patient, the operator, or the environment as a result. In those instances where there is any element of doubt concerning the safety of connected devices, the user must contact the manufacturers concerned (or other informed experts) for proper use. In all cases, safe and proper operation should be verified with the applicable

Manufacturer's instructions for use and system standards IEC 60601-1-1/EN 60601-1-1 must

be complied with.

Electro surgery Unit

- ✓ Electrosurgical unit (ESU) emits a lot of RF interference. If the monitor is used with an ESU, RF interference may affect the monitor operation.
- ✓ Locate the monitor as far as possible from the ESU. Locate them on opposite sides of the operating table, if possible.
- ✓ Connect the monitor and ESU to different AC outlets located as far as possible from each other.
- ✓ When using this monitor with an electrosurgical unit, its return plate and the electrodes for monitoring must be firmly attached to the patient. If the return plate is not attached correctly, it may burn the patient's skin where the electrodes are attached.

During surgery:

Use the appropriate orange electrode ECG safety cable, or lead cable with an red connector, for measuring ECG in the operating room. These cables have extra circuitry to protect the patient from burns during cautery, and they decrease electrical interference. This also reduces the hazard of burns in case of a defective neutral electrode at the HF device. These cables cannot be used for measuring respiration.

Patient preparation

Careful skin preparation and proper electrode placement allow you to receive a strong signal that minimizes handwriting. If a technical alarm (e.g. lead disconnect) has occurred, prepare the patient again according to the following recommendations.

Follow hospital approved clinical procedures to prepare the patient's skin. Change the electrode every 24 to 48 hours to improve signal quality. You may need to replace the electrode more often in the following situations:

- ECG signal degradation
- Excessive sweating of the patient
- Patient's skin irritation

There are a variety of reusable and disposable electrodes available. Choose the electrode that best fits your monitoring situation. Bionet recommends Ag / AgCl disposable electrodes.

If you are using an electrode with a gel beforehand, make sure that the electrode is sufficiently gelled. Never use this product if the disposable electrode has expired or the gel is dry.

Determine the electrode location that will provide the best ECG in the configuration (P-wave and T-wave amplitudes should not exceed 1/3 of the QRS amplitude). Choose a flat, muscular location to maximize contact with the electrodes and minimize muscle fatigue. Avoid joints or bony protrusions. When choosing a location for electrode placement, consider the following special conditions: Surgery - Place electrodes as far away from the surgical site as possible. Burn patient - use sterile electrodes. Thoroughly clean the equipment. Follow hospital infection control procedures.

Use a waterproof tape (about 2 inches wide) or Steri-Drape to secure the electrode. Protect from liquids. Make a small loop from the lead wire just below the connection and secure with tape.

ECG lead

5 LEAD electrode placement

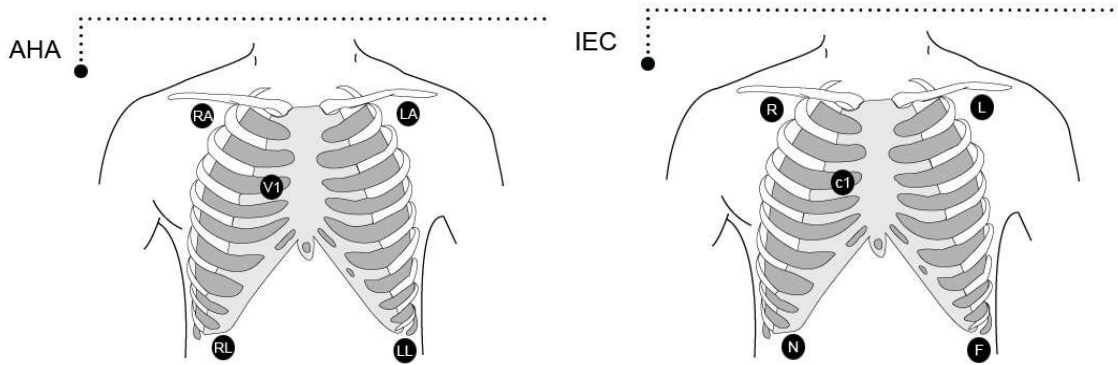

3 LEAD electrode placement

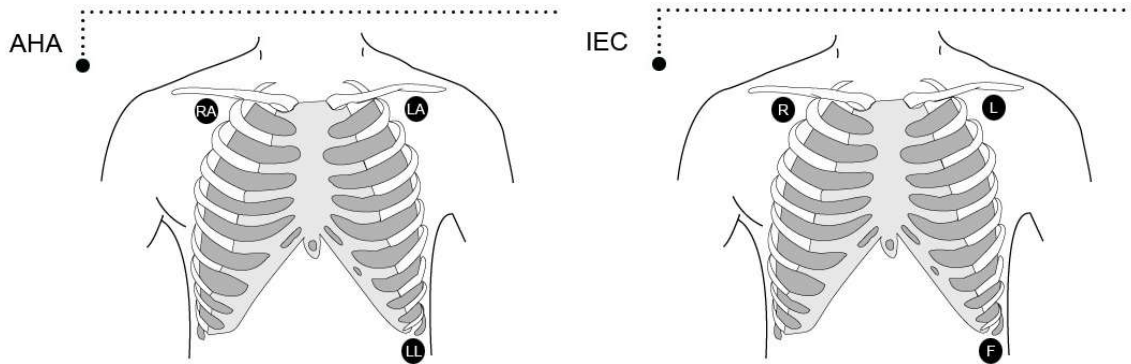

How to attach neonate electrodes

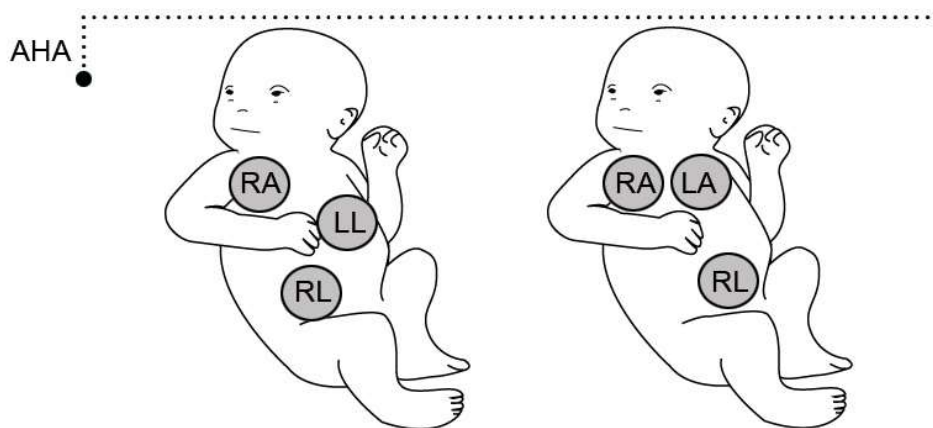

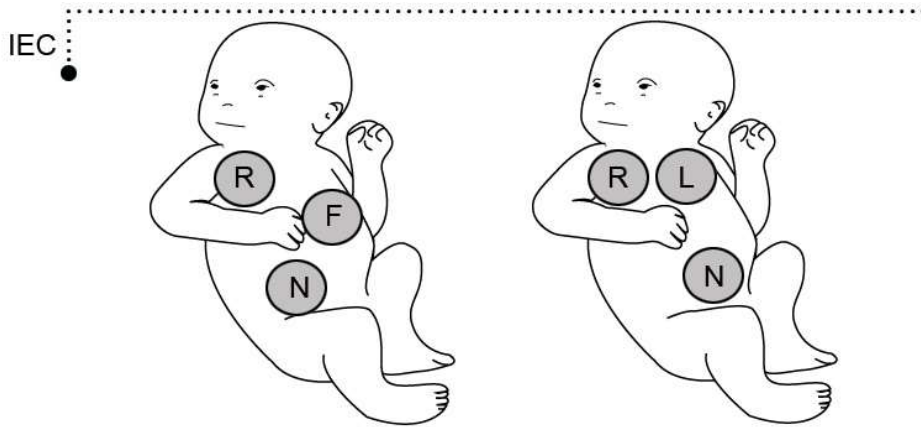

Cable color and size

AHA : American Heart Association (U.S.A. standard)

IEC : International Electro technical Commission (Europe standard)

3LEAD / 5LEAD

Lead wire	AHA Color code	AHA Label	IEC Color code	IEC Label
Right arm	White	RA	Red	R
Left arm	Black	LA	Yellow	L
Right leg	Green	RL	Black	N
Left leg	Red	LL	Green	F
V1(precordial)	Brown	V1	White	C1

ECG signal processing and display

The monitor is a QRS Complex with a QRS complex amplitude of 0.4 to 5.0 mV (0.2-5.0 mV with a scale setting of 0.5 mV / cm or less) and an adult with a QRS width of 70-120 ms (or a newborn with a QRS / ARR Select chapter). The heart rate is calculated from 15 to 300 times per minute using the last 10seconds of the R-R interval and the two longest intervals and the two shortest intervals at the R-R interval. The remaining interval is averaged, and the current heart rate is displayed in the HR parameter box of the main screen as a result.

If arrhythmia monitoring is possible (except for neonatal patients), the HR parameter box will

change accordingly. If you select Basic, you can display three basic arrhythmias called ASYS, VFIB, and VTAC. If Full is selected, a separate ARR parameter box will be displayed next to the HR parameter box (for details on selecting the arrhythmia mode, refer to the Arrhythmia setting chapter).

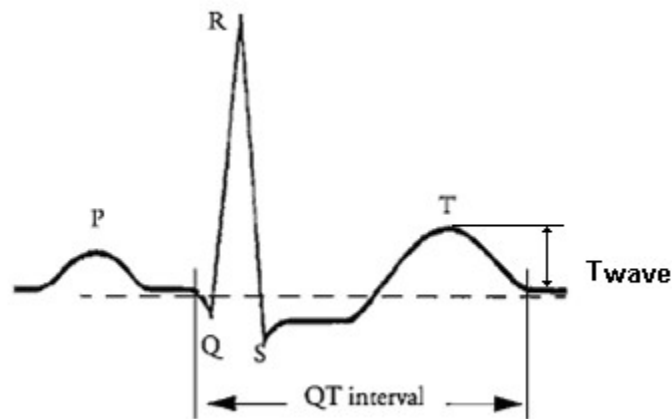

When the ECG signal is 80 BPM, the interval of the T wave is 180 ms, and the QT period is 350 ms.

ST signal processing and display

ST segment deviation is defined as the movement above or below the equipotential level (mm). The difference measurement compares the isoelectric point with the ST measurement point. The isoelectric point defines a zero volt point (no electrical activity, 0 mm) with a base position on the horizontal axis (in hours) of 28 ms before QRS complex generation. In the ST segment, the ST point occurs between the QRS offset (J point) and the T-wave. The default position is 80ms after the QRS offset. The following figure shows a typical QRS complex. The ST analysis features are classified as "normal" beats in up to 12 selected ECG leads QRS Complex.

Alarm and alarm status

High P-wave and T-wave - Long P-wave or T-wave with high amplitude duration can be detected by QRS Complex. Place the leads on the ECG1 channel with the highest R-wave (compare to T-wave and / or P-wave) to allow the monitor to properly detect low heart rate conditions in this situation. If the monitor continues to misinterpret the P-wave or T-wave, use a pulse oximeter to reposition the electrodes or monitor the patient's pulse rate.

Display

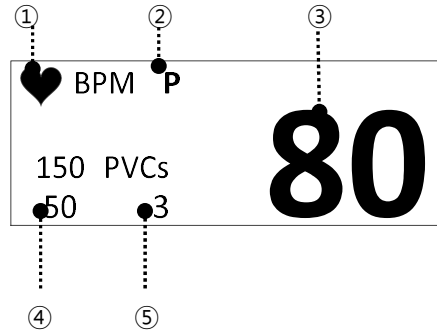

①	Heart rate detector: It detects heart rate and flickers simultaneously.
②	Pace maker: Pace maker signal is detected and flashes simultaneously.
③	HR Alarm limits: Heart rate threshold is display.
④	Heart rate: Displays the heart rate per minute.
⑤	PVC count number per 1 minute is display.

ECG Settings

	Main menu	Sub menu
ECG	A. ECG Parameters	A-1. Alarm
		A-2. QRS Volume
		A-3. Display Option
		A-4. Arrhythmia
		A-5. ST/PVC
		A-6. Pace Maker

A. ECG menu		
MENU	Description	Available settings
A-1. Alarm	ECG alarm setting menu	
A-1-1. PARAMETER ALARM LIMIT	HR, ST, PVC parameter alarm limits, level, activation setup menu.	
A-1-2. TECHNICAL ALARM CONDITION	ECG-LEADFAULT ECG-CHECKELECTRODE ECG-HR-SEARCH	
A-2. QRS VOLUME	QRS detection volume setting menu. When you set the SpO2 volume, it is automatically set to OFF.	OFF, 0%~100%
A-3. DISPLAY OPTION		
A-3-1. SWEEP SPEED	The speed of the ECG displayed on the screen can be set. Default setting: 25mm/s	6.25mm/s, 12.5mm/s, 25mm/s, 50mm/s
A-3-2. FILTER	The filter setting is MONITOR by default. ECG FILTER : Selects among four frequency bands to filter the signal. MONITOR 0.5Hz ~ 40Hz MODERATE 0.5Hz ~25Hz MAXIMUM 5Hz ~ 25Hz DIAGONOSIS 0.05Hz ~150Hz	MONITOR MODERATE MAXIMUM DIAGONOSIS
A-3-3. SIZE (SENSITIVITY)	Changes the display amplitude of the ECG waveform.	0.25 , 0.5, 1, 2, 4mm/mV
A-3-4. HR SOURCE	The cardiac source can be selected as ECG or SpO2, AUTO.	ECG, SpO2, AUTO
A-3-5. VIEW CHANNEL	Number of channels in the ECG waveform to be shown on the screen. Display two lines of 1CH ECG	1CH,

	waveform.	
A-3-6. TRACE 1	<p>The ECG channel is selectable from I to V6.</p> <p>3 When using the lead cable selection, only TRACE I can select I, II, III.</p> <p>5 lead cable selection I, II, III, aVR, aVL, aVF, V can be selected.</p>	I, II, III, aVR, aVL, aVF, V1,V2,V3,V4,V5,V6
A-4. Arrhythmia	Arrhythmia alarm setting menu	
A-5.ST/PVC	PVC Diagnostic setting, ST template channel selection, ST analysis and ISO (R-) / ST (R +) value setting	
A-5-1. PVC Analysis	PVC Diagnostic Results Display Setup Menu	ON/OFF
A-5-2. ST Template Ch	ST Diagnostic ECG Channel Setup Menu(Menu display according to the currently connected cable)	Lead I, II, III, aVR, aVL, aVF, V
A-5-3. ST Analysis	ST Diagnostic ECG Channel Setup Menu	
A-5-4. ISO(R-)	ISO Point Position Setting Menu	120 ~ 4ms
A-5-5. ST(R+)	ST point position setting Menu	4~160 ms
A-5-6. Initial Setup	ISO, ST point position initial value setting Menu	ISO : 80 ST : 108
A-6. Pace Maker	Pace Maker detection display setting	ON/OFF

Trouble shooting

Problem:

Inaccurate heart rate and/or false asystole.

Solution:

Check ECG signal from patient:

1. Check/adjust lead placement.
2. Check/perform skin preparation.
3. Check/replace electrodes.

Check amplitude of ECG waveform:

1. Select ECG parameter label.
2. Select DISPLAY LEAD,
3. Scroll through all ECG leads and check for 0.5mV amplitude at normal (1X) size. (at least 0.5mV amplitude is required for QRS detection.) for borderline signals, validate on a graph.
4. If amplitudes are low, electrodes may need to be repositioned or replaced.

Problem:

False ventricular calls.

Solution:

Check ECG signal from patient: (the chest lead may exhibit polarity changes which may occasionally cause an inaccurate call.)

1. Check/adjust lead placement.
2. Check/perform skin preparation.
3. Check/replace electrodes. (if chest lead is a problem, move the chest lead to another chest position or leg position.)

Problem:

Inaccurate pacemaker detection

Solution:

Use pacemaker processing:

1. Select ECG parameter label.
2. Display the lead of ECG with the greatest amplitude in the top waveform position.
3. Select Pace Maker.
4. SELECT PACE MAKER ON.

8. Arrhythmia Monitoring(*)

Overview

On supported models only(*), Arrhythmia monitoring is available for adult and pediatric patients. The selected mode (Lethal or OFF) determines which events are processed. Arrhythmia monitoring is not available for newborns. Arrhythmia monitoring is available for adult and pediatric patients only. The monitor compares the received beats to the reference beats that have been recorded and stored in the reference template. Through this process, the monitor can identify the occurrence of an arrhythmia event, classify it, and then draw clinically useful conclusions based on the frequency and type of the signal. The monitor will observe all beats in question if the baseline moves beyond a defined limit. The monitor uses QRS processing results for arrhythmia analysis. During multiple lead arrhythmia treatment, measure the QRS Complex of each lead and compare it to the main learned beats. The monitor classifies the beats based on information obtained from all available leads.

Arrhythmia templette

ASYSTOLE

Ventricular asystole occurs whenever the displayed heart rate drops to zero.

VFIB/VTAC

Ventricular fibrillation occurs when the ECG waveform indicates a chaotic ventricular arrhythmia.

Arrhythmia Settings

A. ECG menu

MENU	Description	Available Settings
A-1. Arrhythmia	ARRHYTHMIA parameter alarm, level, Activation setup menu.	
A-1-1. Arrhythmia Type	Sets up ON/OFF to indicate detection of diagnosis (Asys, VTAC/VFIB and VTAC). OFF: Do not perform arrhythmia diagnosis. LETHAL: Performs the detection of Asys, VTAC/VFIB, and VTAC at the selected lead	OFF, LETHAL
A-1-2. Arrhythmia Alarm Condition	Alarm setting menu by arrhythmia type	

Warning

Display Heart Beat Equipment Signal

Heart Beat equipment signal displays when the PACE mode is. the signal appears series form. The signal size or form are meaningless clinically

Number Of Heart Beat

Attention to the patient with heart beat equipment. The heart beat equipment can show heart beat even during arrhythmia continuously. Therefore, do not depend on heart beat alarm excessively.

Warning**VENTRICULAR ARRHYTHMISAS**

The arrhythmia analysis program is intended to detect ventricular arrhythmia. This program is not designed to detect atrial or supra ventricular arrhythmias. In some cases, it may not be possible to distinguish the presence or absence of arrhythmias. Therefore, doctors should analyze the arrhythmia information like other medical information.

SUSPENDED ANALYSIS

Certain conditions can delay the arrhythmia analysis. Detection and alarms associated with arrhythmias do not occur when arrhythmia conditions are delayed. This message is generated when the arrhythmia analysis is delayed:

LEADS FAULT, ALARM PAUSE, ALL ALARMS OFF, DISCHARGED.

9. SpO₂

Overview

SpO₂ monitoring is a non-invasive technique that measures the total amount of oxygen in hemoglobin. The pulse rate is measured by measuring the absorption of the wavelength of the selected light. The light emitted by the sensor in the probe passes through the tissue and is converted into an electrical signal by the light-detecting sensor in the probe. The monitor processes the electrical signal and displays the waveform, %SpO₂, and pulse rate on the screen as quantified values. Red and infrared rays are passed through the capillaries of the fingertip to detect the pulsating component, calculate HR and oxygen saturation, and alarm according to the set alarm value.

Precaution

SpO₂ measurements are particularly sensitive to arterial and arteriolar pulse rates. Patients experiencing shock, hypothermia, anemia, or patients taking medications that reduce arterial blood flow may have incorrect measurements.

Warning:

- The pulse oximeter cannot be used as an apnea monitor.
- High oxygen levels can make premature babies vulnerable to retrolental fibroplasia. When this is the case, do not set the maximum alarm limit to 100%, such as the effect of turning off the alarm. Percutaneous pO₂ monitoring is recommended for premature infants receiving supplemental oxygen.
- Inspect the applied area every 2-3 hours to check the skin condition and check if it is attached to the naked eye. If skin conditions change, move the sensor to another location. Change the application site every 4 hours at least.
- Use only Bionet-designated sensors. Other sensors may not provide adequate protection against defibrillation or may put the patient at risk.
- Disposable accessories (disposable electrodes, transducers, etc.) should be used only once. Do not reuse disposable accessories.

Patient preparation

The accuracy of SpO₂ monitoring is largely dependent on the strength and quality of the SpO₂ signal.

If you use your fingers as a monitoring site, remove the nail polish. Cut the patient's fingernail if needed to improve placement of the sensor. Only use sensors provided by Bionet and apply them according to manufacturer's recommendations on a per-sensor basis.

If the sensor is not attached correctly, the ambient light may interfere with the pulse oximetry, making the measurement irregular or causing the value to disappear. If you suspect interference from ambient light, make sure that the sensor is properly positioned and that the sensor cover with the opaque body is covered.

1. Select the sensor type and size that best suits your patient.
2. If the sensor can be reused, please wash it before use for each patient.
3. Position the sensor correctly and attach it to the patient.
4. Connect the sensor to the patient cable.
5. Check the application area of the sensor from time to time. If the sensor is too tight, it may delay blood flow or overheat the skin and damage the tissue. Do not use a damaged sensor.

Note: Read the documentation that came with your sensor for the best application technology and safety information. Never use a damaged sensor.

Note: If the sensor does not turn on after connecting the sensor, observe that a message appears on the monitor. If the sensor-LED does not turn on, replace the sensor.

SpO₂ connector

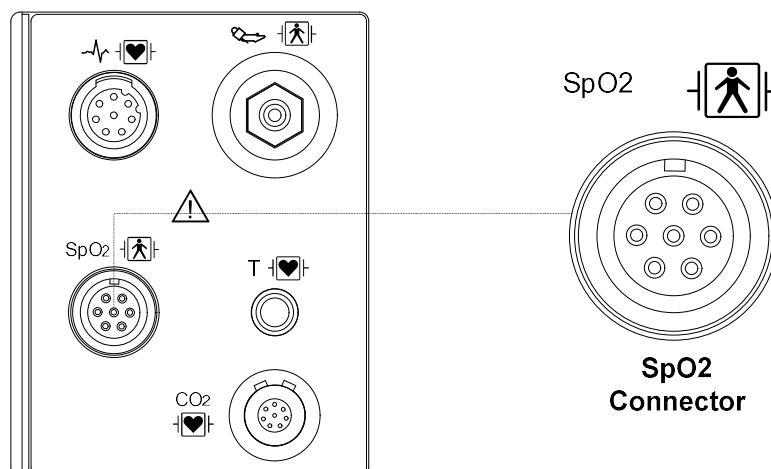

SpO2 measurement Cable



Note

The signal input is a high-insulation port and it is defibrillator protected ()

The insulated input ensures patient safety and protects the device during defibrillation and electro surgery.

Display

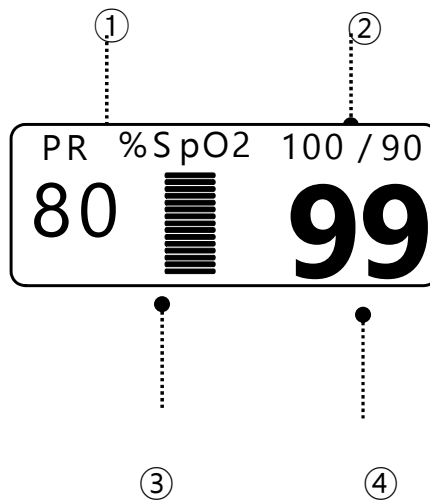

①	SpO2 pulse rate display
②	SpO ₂ PI (Perfusion Index) measurement display

③	SpO2 Alarm limits display
④	SpO2 strength indicator
⑤	%SpO2 Value display

The current SPO2 value and the derived pulse rate (RATE) are displayed. The block sets indicate the strength of the signal (twenty block bars indicate the strongest signal). The SPO2 measurements are averaged over a 6-second period of time.

The monitor display is updated every second.

The SPO2 monitoring features are found in the SPO2 menu. These features include alarm limit adjustment, display of RATE, and RATE volume.

Note
SpO2 WAVE SIZE is changed automatically.

Signal and Data Validity

It is extremely important to determine that the probe is attached to the patient correctly and the data is verifiable. To make this determination, three indications from the monitor are of assistance—signal strength bar, quality of the SPO2 waveform, and the stability of the SPO2 values. It is critical to observe all three indications simultaneously when ascertaining signal and data validity.

Signal Strength Bar

The signal strength bar is displayed within the SPO2 values window. This bar consists of 10 blocks set depending on the strength of the signal. Proper environmental conditions and probe attachment will help to ensure a strong signal.

Quality of SPO2 Waveform

Under normal conditions, the SPO2 waveform corresponds to (but is not proportional to) the arterial pressure waveform. The typical SPO2 waveform indicates not only a good waveform, but helps the user find a probe placement with the least noise spikes present. The figure below represents an SPO2 waveform of good quality.

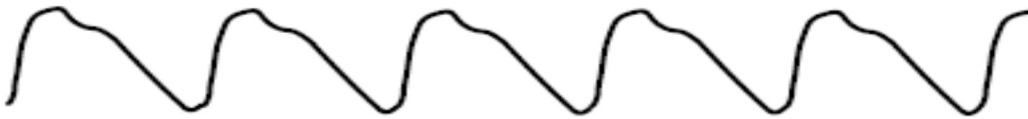

Good Quality SPO2 Waveform

If noise (artifact) is seen on the waveform because of poor probe placement, the photo detector may not be flush with the tissue. Check that the probe is secured and the tissue sample is not too thick. Pulse rate is determined from the SPO2 waveform which can be disrupted by a cough or other hemodynamic pressure disturbances. Motion at the probe site is indicated by noise spikes in the normal waveform. (See the figure below.) It has been noted that letting the patient view the SPO2 waveform enables them to assist in reducing motion artifact.



SPO2 Waveform with Artifact

Stability of SPO2 Values

The stability of the displayed SPO2 values can also be used as an indication of signal validity. Although stability is a relative term, with a small amount of practice one can get a good feeling for changes that are artifactual or physiological and the speed of each. Messages are provided in the SPO2 values window to aid you in successful SPO2 monitoring.

WARNING

In the monitoring of patients the coincidence of adverse conditions may lead to a disturbed signal going unnoticed. In this situation artifacts are capable of simulating a plausible parameter reading, so that the monitor fails to sound an alarm. In order to ensure reliable patient monitoring, the proper application of the probe and the signal quality must be checked at regular intervals.

SPO2 Settings

A. SPO2 menu		
MENU	Description	Available Settings
A-1. Alarm	SPO2 Alarm setup menu	
A-1-1. PARAMETER ALARM LIMIT	PERCENT, PR parameter alarm , level , activate setup menu	
A-1-2. TECHNICAL ALARM CONDITION	SPO2-PROBEOFF SPO2-CHECKPROBE SPO2-POORSIGNAL SPO2-LOSTPULSE SPO2-ARTIFACT SPO2-PULSE SEARCH	
A-2. RATE VOLUME	Menu in which RATE VOLUME is set up When the ECG volume is set, it is automatically set to OFF.	OFF, 0%~100%
A-3. DISPLAY OPTION	SPO2 waveform display setting	
A-3-1. SWEEP SPEED	It can set the speed of SPO2 displayed on the screen. Default: 25 mm/s.	6.25mm/s, 12.5mm/s, 25mm/s, 50mm/s

Status messages

Below is a list of system status alarm messages which may be displayed in the SPO2 parameter window during monitoring.

CHECK PROBE

Reusable finger probe is off the patient. Check the probe. The factory default for this alarm is MESSAGE ALARM.

PULSE SEARCH

Detection by the monitor of a repeatable pulse has ceased. Check the patient and the probe site.

POOR SIGNAL

The SPO2 signal is too low. No SPO2 data is displayed. This can be due to a low patient pulse, patient motion, or some other interference. Check the patient and the probe.

LOST SIGNAL

SPO2 data continues to be displayed, but the quality of the signal is questionable. Check the patient and the probe.

ARTIFACT

It indicates that something happened to the pulses; determine if the artifact to be abnormal and irregular

Cleaning

- Do not autoclave, pressure sterilizes, or gas sterilizes this oximeter.
- Do not soak or immerse the monitor in any liquid.
- Use the cleaning solution sparingly. Excessive solution can flow into the monitor and cause damage to internal components.
- Do not touch, press, or rub the display panels with abrasive cleaning compounds, instruments, brushes, rough surface materials, or bring them into contact with anything that could scratch the panel.
- Do not use petroleum-based or acetone solutions, or other harsh solvents, to clean the oximeter. These substances attack the device's materials and device failure can result.

10. RESPIRATION

Overview

Respiration via ECG Lead I or Lead II electrode makes the skin area of the chest enlarged, causing changes in the resistance of skin. Through this it calculates respiration value per minutes and performs the alarm function according to limit value.

The monitor can use ECG leads I or II for breath detection, regardless of the leads selected for QRS processing. The measurement range for impedance breath monitoring is 0 to 155 breaths per minute. The alarm setting range is 5 ~ 150 breaths per minute. In neonatal and pediatric mode, the monitor can detect central apnea. You can monitor the heart rate, SpO₂ using the appropriate accessories, and display the relevant values in the Oxycardiorespirogram.

RESP precaution

Safety and efficacy of respiration measurement methods for apnea detection, especially apnea of premature babies and apnea of infants, have not yet been established.

- This device does not monitor obstructive apnea. Patients in a breathing crisis should be closely monitored.
- Impedance breath monitoring should not be considered the only way to detect breathing stops. Bionet recommends monitoring of additional parameters, such as EtCO₂ and SpO₂, that indicate the patient's oxygen supply status.
- • If you use an ESU block or cable, the impedance breath monitor may not work and the pacemaker detection performance may be degraded. If pacemaker detection is enabled, ESU interference may be detected as a pacemaker.
- • Large amplitude pacemaker pulses (> 100mV) may interfere with the monitor's breath measurement or detection function.

Patient Preparation

Skin preparation and electrode placement must be properly and carefully monitored in impedance breath monitoring. You can produce reliable results. Follow the same recommendations as ECG monitoring. Please. In general, the electrodes should be placed as clean as possible with the 60Hz noise minimized. Make it possible to generate a signal. The best results can be obtained when the electrode is firmly bonded and the electrode area is wide. To improve the RESP signal, use a 5-lead cable set (RL as a neutral electrode). It is recommended that the electrode be placed in the maximum expansion and contraction range of the lung, especially if deep breathing is involved. For newborns, place the RA and LA electrodes on the mid-axillary line with the nipple. Place the LL electrodes under the diaphragm and navel. Avoid the liver and the ventricles of the heart to prevent 60Hz noise from pulsatile blood circulation. The following figure shows where we recommend placing ECG leads for impedance breathing in adults and neonates

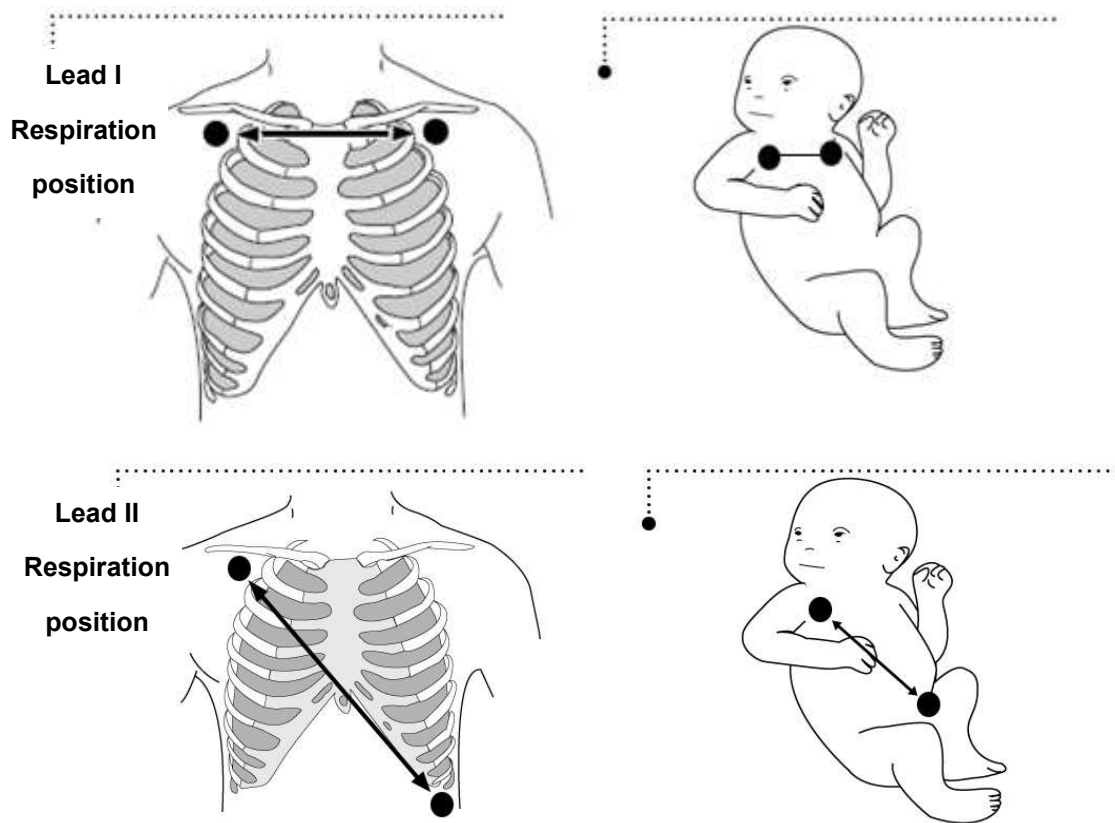

Respiration connector and measurement cable

Respiration connector

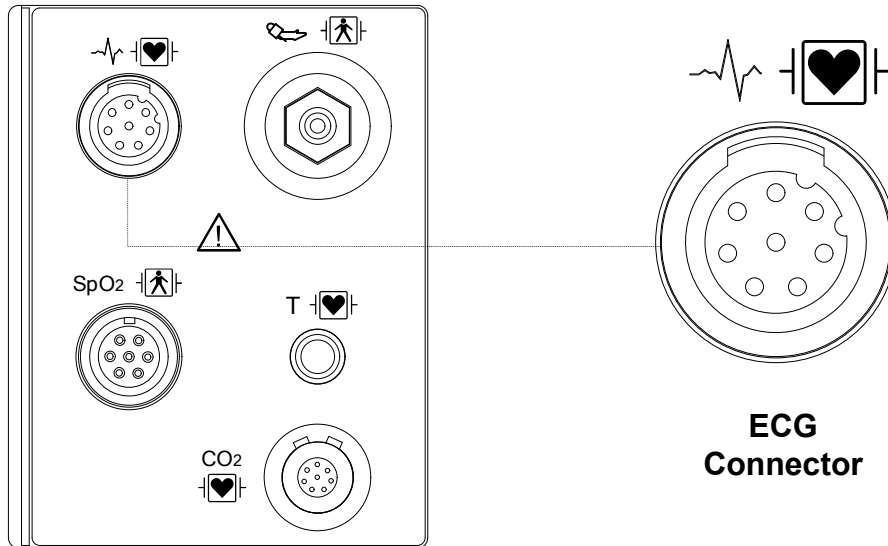

Respiration cable



Note

Respiration Rate measures the cable and connector will be used as the ECG and common.

Display

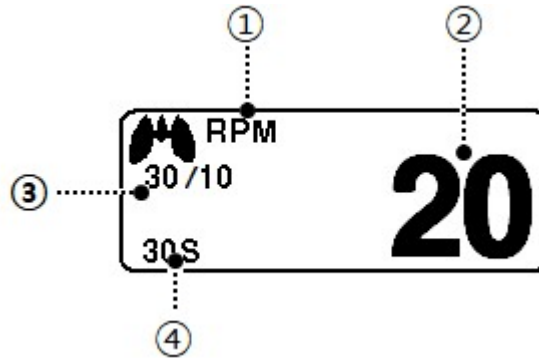

①	Breathe indicator: indicates the detected breath
②	Breathing number : displays the number of respiration per minute
③	Respiration alarm limit: indicates respiration limits
④	Apnea limit Setting: Apnea limit sign

RESP Settings

A. RESP menu		
Menu	Description	Available Settings
A-1. Alarm	RESP Alarm setting menu	
A-1-1. PARAMETER ALARM LIMIT	RR, APNEA Parameter alarm , level ,Activation setup menu	
A-1-2. TECHNICAL ALARM CONDITION	RESP-CABLE OFF RESP-LEAD FAULT RESP-CHECK ELETRODE	
A-2. DISPLAY OPTION	This is for changing the reference LEAD for respiration	
A-2-1. SWEEP SPEED	A menu to setup Wave Display of speed	6.25mm/s, 12.5mm/s, 25mm/s,
A-2-2. SIZE	A menu to setup Wave Display	2, 4, 6, 8, 10
A-2-3. LEAD SELECT	This is for changing the reference LEAD for respiration	LEAD I LEAD II
A-3. APNEA DETECT	A menu to setup APNEA alarm display	OFF/ ON

OxyCRG monitoring

The monitor can display Oxycardiorespirogram (OxyCRG or OCRG) in neonatal mode. OCRG displays updated HR trend, SpO2 or trend, respiratory / etCO2 waveforms, as well as apnea events in 3 or 6 consecutive minutes. The monitor will continue to update the main screen parameters, alarm announcement, and alarm recording start.

OxyCRG display method:

1. Set patient type to Neonatal
2. Connect SpO2 sensor, HR lead and breath or etCO2 lead.
3. Set the apnea time in the RESP menu.
4. Press the TREND icon key.
5. Click OxyCRG to display the OxyCRG screen.

Scale

To change the HR scale:

1. Select the parameter window using the rotary knob and click.
2. Turn the dial to the desired scale setting and click.

The values are shown in the following table (you can only modify HR scales).

Cursor

When you select the cursor box, a vertical bar is displayed in the trend area of the screen. The number on the left of the screen no longer indicates the scale value, but the parameter value of the time marked with the cursor is displayed. The monitor continuously displays the current value (real time) on the right side of the screen. When the cursor is moved to the right or left with the rotary knob, it is corrected and displayed accordingly.

Parameter definition

The highest (maximum) and lowest (lowest) HR values over the last 6 minutes
SpO2 50 -100% The lowest saturation value over the last 6 minutes

Respiration waveform

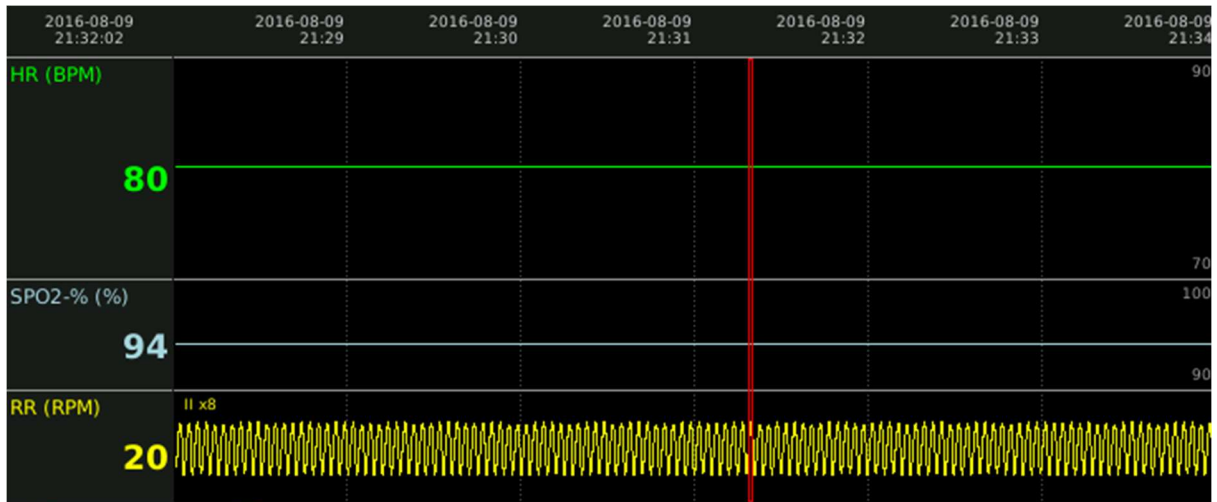

OxyCRG Setup menu

MENU	Description	Available Settings
ECG AUTO SCALE	ECG RANGE AUTO SCALE setup	ON/OFF
ECG MANUAL SCALE	ECG RANGE MANUAL SCALE setup	
PARAMETER TYPE	RESP, ETCO2 parameter setup menu	RESP ETCO2

11. NIBP

Overview

The monitor can acquire and process non-invasive blood pressure (NIBP) signals and display the output. Blood pressure measurements are determined by the oscillometric method and are equivalent to those obtained by intra-arterial methods, within the limits prescribed by the Association for Advancement of Medical Instrumentation, Electronic Automated Sphygmomanometers (AAMI/ANSI SP-10).

If the pulse signal is poor due to patient movements, improper cuff placement or noise in the signal, the cuff deflates and the monitor attempts a second measurement. For causes and possible remedies for a poor pulse signal see the alarm message tables. The hose connects the cuff to the monitor to determine the contraction, expansion and mean blood pressure of an adult, pediatric or neonatal patient. The monitor can start the blood pressure measurement alone with set intervals, or persistence lasting more than 5minutes.

NIBP Connector

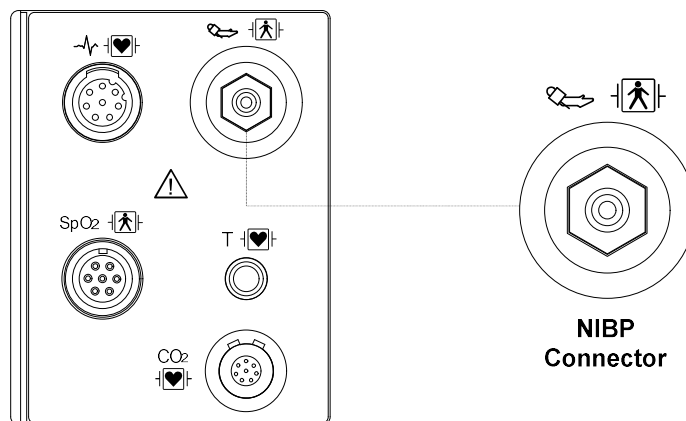



Adult Cuff



Optional accessory list

<p>Thigh Adult</p>		<p>Big Adult NIBP Cuff Cuff Size : 458 * 143 Arm circumference : 45 to 56.5Cm Option</p>
<p>Big Adult</p>		<p>Big Adult NIBP Cuff Cuff Size : 458 * 143 Arm circumference : 35.5 to 46 Cm Option</p>
<p>Child</p>		<p>Child NIBP Cuff Cuff Size : 430 * 108 Arm circumference : 20.5 to 28.5 Cm Option</p>
<p>Pediatric</p>		<p>Pediatric NIBP Cuff Cuff Size : 313 * 88 Arm circumference : 13.8 to 21.5 Cm Option</p>
<p>Infant</p>		<p>Infant NIBP Cuff Cuff Size : 210 * 60 Arm circumference 9 to 14.8 Cm Option</p>
<p>Neonate</p>		<p>NIBP Disposable Cuff Neonate 1 (3.3~5.6cm) Option</p>

	NIBP Disposable Cuff Neonate 2 (4.2~7.1cm) Option
	NIBP Disposable Cuff Neonate 3 (5.0~10.5cm) Option
	NIBP Disposable Cuff Neonate 4 (6.9~11.7cm) Option

Note

The NIBP should be set in the menu because the measured value differs depending on the patient's age and gender.

Display

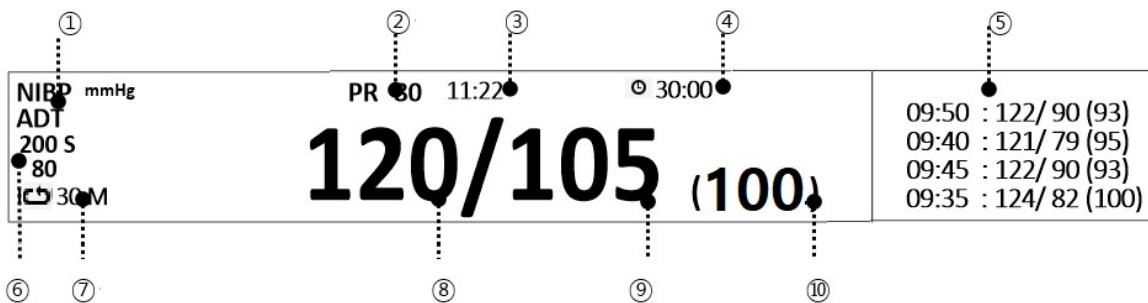

①	Measurement Cuff type.
②	Pulse rates: Indicates pulse rate.
③	Measurement time: Indicates the completion time of measuring.
④	Measure time: Indicates the schedule counter time of measuring.
⑤	Indicates recent measurement data.

⑥	Systolic Alarm limit: Indicates alarm limit of blood pressure.
⑦	Interval Time: indicates interval time when measures the blood pressure periodically.
⑧	Systolic blood pressure: Indicates the maximum limit of blood pressure.
⑨	Diastolic blood pressure: Indicates the maximum limit of blood pressure.
⑩	Mean blood pressure: Indicates the maximum limit of blood pressure.

NIBP Settings

A. NIBP menu		
Menu	Description	Available Settings
A-1. Alarm	NIBP Alarm setup menu	
A-1-1. PARAMETER ALARM LIMIT	SYS, MEAN, DIA Parameter alarm limit, level , activation setup	
A-1-2. TECHNICAL ALARM CONDITION	NIBP-OVER PRESSURE NIBP-OVERTIME PRESSURE NIBP-INFLATION FAILURE NIBP-DEFLATION FAILUER NIBP-MEASUREMENT ERROR NIBP-PULSE TOO WEAK NIBP-AIR LEAK NIBP-EXCESSIVE MOTION NIBP-SYSTEM FAULT	
A-2. CUFF SIZE	A menu to select cuff size	ADULT PEDIATRIC NEONATE
A-3. INFLATION	It is a function to set the range that is usually used by setting pressure at the beginning because it can give pain to the patient when the equipment is	ADT : 120 – 250 mmHg PED :

	<p>turned on and pressurized to the maximum pressure range at the initial pressurization.</p> <p>Default Settings value:</p> <p>ADT : 170 mmHg</p> <p>PED : 140mmHg</p> <p>NEO : 120mmHg</p>	<p>80 – 170mmHg</p> <p>NEO :</p> <p>60 – 140mmHg</p>
A-4. SETTING TIME	<p>How to apply pressure value setting.</p> <p>Once: When the blood pressure is measured for the first time, the pressure is set to the set pressure value, but automatically adjusted according to the patient's blood pressure value.</p> <p>Every Time: Whenever blood pressure is measured, pressurize to the set pressure value every time</p>	<p>Once,</p> <p>Every Time</p>
A-5. AUTO MEASUREMENT INTERVAL	<p>A menu to set Interval time when measures the blood pressure periodically.</p> <p>After setting INTERVAL, you must press NIBP KEY to start NIBP START periodically.</p>	<p>1min, 2, 3, 4, 5, 10, 15, 20, 30, 1hour, 2, 4, 8</p>
B-1. NIBP STAT	<p>Patients with severe state changes in blood pressure are in continuous mode for 5minutes to check for changes in blood pressure continuously.</p>	<p>OFF / ON</p>
C-1. VITAL SIGN REVIEW	<p>Record the 40 most recently measured blood pressure values.</p>	

Warning

Check periodically to see if the circulation from the cuff to the distal part of the patient's arm is good.

1minute and 2minute intervals When using automatic measurement, check the patient's condition frequently. It is not recommended for measuring blood pressure for a long time after the measurement time period is set to 10minutes or less.

Note**Safety Considerations**

Software and Hardware for Cuff pressure Blocking:

The cuff is automatically reduced when the measurement time is longer than two minutes in Adult / Pediatric mode and more than 90seconds in Neonatal mode. Extension limits are set for all patient categories to prevent overpressure on the patient.

The maintenance is performed every 2 years.

Check the following list devices to operates properly and safety at all times.

1. Check for proper cuff size.
2. Check for residual air left in the cuff from a previous measurement.
3. Make sure cuff is not too tight or too loose.
4. Make sure cuff and heart are at same level, otherwise hydrostatic pressure will offset the NIBP value.
5. minimize patient movement during measurement.
6. Watch for pulses paradox us.
7. Check for leak in cuff or tubing.
8. Patient may have a weak pulse.

It recommended PATIENT position in NORMAL measurement, as below;

- 1) Comfortably seated
- 2) Legs uncrossed
- 3) Feet flat on the floor
- 4) Back and arm supported
- 5) Middle of the CUFF at the level of the right atrium of the heart

a recommendation that 5min should elapse before the first reading is taken

Measurement Limitations

Measurements are impossible with heart rate extremes of less than 40 bpm or greater than 300 bpm, or if the patient is on a heart-lung machine.

The measurement may be inaccurate or impossible:

- With excessive and continuous patient movement such as shivering or convulsions
- if a regular arterial pressure pulse is hard to detect
- With cardiac arrhythmias
- With rapid blood pressure changes
- With severe shock or hypothermia that reduces blood flow to the peripheries
- With obesity, where a thick layer of fat surrounding a limb dampens the oscillations coming from the artery
- On an edematous extremity.

The effectiveness of this sphygmomanometer has not been established in pregnant, including preeclamptic patients.

Cuff Selection and Placement

The quality of NIBP monitoring depends largely on the quality of the signals received by the monitor.

For this reason, it is important to select the correct cuff size for your patient. Cuff sizes are clearly

marked on the cuff. Measure the circumference of your patient's limb. Use only Bionet cuffs with your monitor.

Warning

Non-invasive blood pressure monitoring is not recommended for patients with hypotension, hypertension, arrhythmias or extremely high or low heart rate. The software algorithm cannot accurately compute NIBP or patients with these conditions.

Warning

As the value of NIBP can vary according to the age and sex of a patient, the user needs to set up right data in parameter Menu before measurement. Tubes between the cuff and the monitor are not kinked or blocked.

Pay attention to not to block connecting hose when you put cuff on patient.

Cuff or hose connection for leaks periodically. Measurements can be inaccurate if air leaks.

The air pad should be exactly over the branchial artery. Tubing is immediately to the right or left of the branchial artery to prevent kinking when elbow is bent.

Try to measure infants when they are calm. A kicking or crying baby may disturb or jiggle the cuff, causing noise within the system and resulting in unstable blood pressure readings. If necessary, hold the cuffed limb steady, without impeding circulation. Do not hold onto the cuff and do not pat the cuffed limb to comfort the child.

NIBP cannot be taken under all conditions. Even manual methods, employing a sphygmomanometer and stethoscope, will not work on unstable or active patients.

Pressurization of the CUFF can temporarily cause loss of function of simultaneously used monitoring ME EQUIPMENT on the same limb

The need to check that operation of the NIBP does not result in prolonged impairment of the circulation of the blood of the PATIENT

Status Messages

If the cuff hose is not connected properly	→ INFLATION FAILURE CHECK CUFF
When the cuff pressure is excessive	→ OVER PRESSURE
When the cuff breaks and cannot exhaust	→ DEFLATION FAILURE
When the cuff pressure exceeds the set time	→ OVER TIME CUFF PRESSURE
When there is no measurement signal	→ MEASUREMENT ERROR

12. EtCO2(*)

Overview

On supported models only(*), the BM Series monitor measures concentrations of end-tidal CO₂ (EtCO₂) when this option is enabled and the EtCO₂ module is connected to your monitor. The EtCO₂ module can perform mainstream measurements in all monitoring modes and sidestream measurements in the adult and pediatric monitoring modes. For sidestream measurements, the capnostat fits on the nasal sampling cannula tubing.

EtCO₂ connector position and Accessory (Sidestream, Respirationics)

EtCO₂ connector

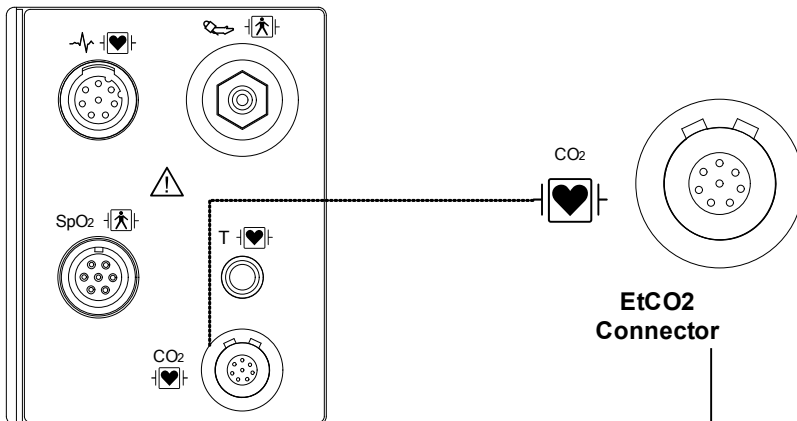

LoFlo sidestream CO₂ sensor and connector









Sidestream sensor



Sidestream sensor connector

Sidestream EtCO₂ Accessories

Intubation Sidestream accessories			
PART	FIGURE	Description	type
3468ADU-00		Nasal CO ₂ Sampling Cannula	Adult
3468PED-00		Nasal CO ₂ Sampling Cannula	Child
3468INF-00		Nasal CO ₂ Sampling Cannula	Neonate
3470ADU-00		Oral/Nasal CO ₂ Sampling Cannula	Adult
3470PED-00		Oral/Nasal CO ₂ Sampling Cannula	Child
3469ADU-00		Nasal CO ₂ Sampling Cannula w/ O ₂ Delivery	Adult
3469PED-00		Nasal CO ₂ Sampling Cannula w/ O ₂ Delivery	Child

3469INF-00		Nasal CO ₂ Sampling Cannula w/ O ₂ Delivery	Neonate
3471ADU-00		Oral/Nasal CO ₂ Sampling Cannula w/ O ₂ Delivery	Adult
3471PED-00		Oral/Nasal CO ₂ Sampling Cannula w/ O ₂ Delivery	Child

Intubation accessories

3473ADU-00		Airway Adapter Kit w/ Dehumidification Tubing	Adult /child (ET Tube Size >4.0 mm)
3473INF-00		Airway Adapter Kit w/ Dehumidification Tubing	child/Neonate (ET Tube Size <=4.0 mm)

EtCO2 Placements and Accessories (Mainstream, Respironics)

EtCO2 connector

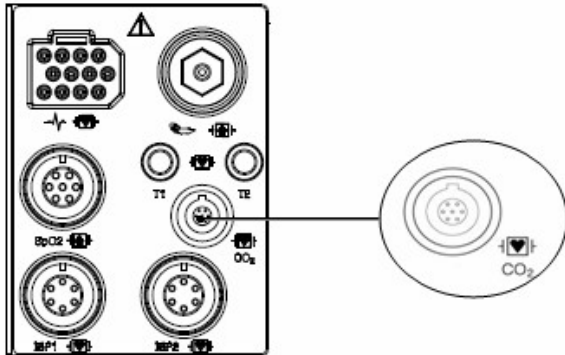

CAPNOSTAT 5 mainstream CO2 sensor and connector



Mainstream Sensor

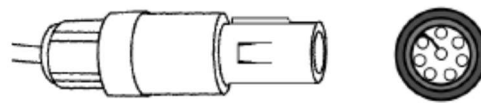

Mainstream Sensor Connector

Mainstream EtCO2 Accessories

Intubation patient Airway adaptor		
Model	Picture	Description
6063-00		Adult/Neonate(disposable)
312-00		Neonate(Disposable)
7007-00		Adult/Neonate (Reusable)
7053-00		Neonate(Reusable)

Precaution

Warning

- The safety and efficacy of breath measurement methods for apnea detection, especially apnea of premature babies and apnea of infants, have not yet been established.
- Patient monitors that measure CO₂, anesthetics, and / or respiratory mechanics cannot be used as apnea monitoring and / or recording equipment. While these products provide an apnea alarm, the alarm condition begins with the elapsed time from when the last breath was detected. However, there are a number of physiological indications for the clinical diagnosis of real apnea events.
- The CO₂ alarm is not activated until the first breath is detected after the monitor is turned on or the patient is discharged.
- Accuracy of the CO₂ and breathing rate measurements may be impaired due to improper attachment of the sensor or due to certain patient conditions and certain environmental conditions.
- If the tube connection is faulty, loose or damaged, gas may leak and the accuracy of the measurement may be lowered, resulting in poor breathing. To prevent this, connect all component is securely and check the connection according to standard clinical procedures to ensure that there are no leaks.

Warning

- Industrial safety: Carefully dispose of used sampling tubes and T-connectors as they may cause infection. There is a risk of infection. Dispose of all equipment in accordance with local regulations.
- Optimize reaction time by minimizing dead space and keeping sample collection tubes as short as possible. Long sampling tubes can lead to poor accuracy and slow response times for sidestream measurement techniques.
- Do not place the airway adapter between the suction catheter and the endotracheal tube when using the sample collection line as a closed suction device for tuborous patients. This is to ensure that the airway adapter does not interfere with the function of the suction catheter.

Sampling method

Connecting the CAPNOSTAT® 5 CO2 Sensor to the Host System

1. Insert the CAPNOSTAT 5 CO2 Sensor connector into the receptacle of the host monitor as shown in Figure 1.

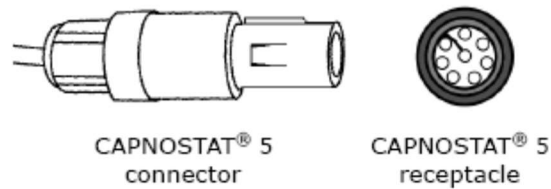

Figure 1

2. Make sure the arrows on the connector are at the top of the connector and line up the two keys of the connector with the receptacle and insert.

3. To remove the connector, grasp the body portion of the connector back and remove.

Note: Do not remove by pulling cable.

Shown below is the CAPNOSTAT 5 CO2 Sensor connection to a Respironics Novamatrix CO2 adapter:

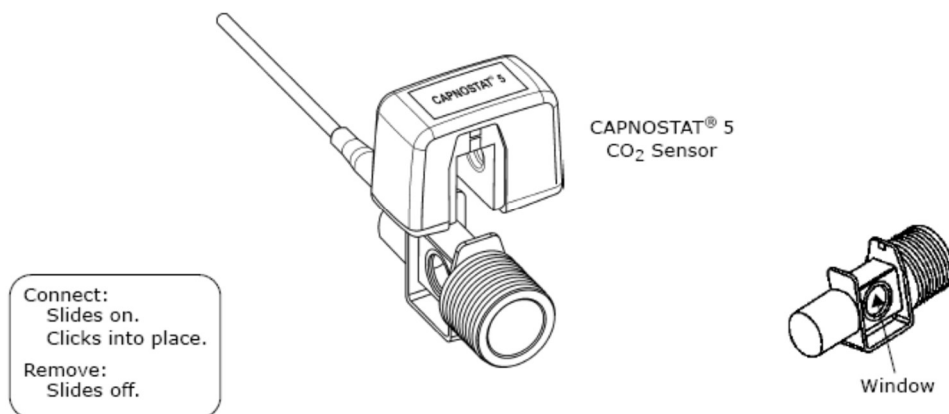

Shown below is the CAPNOSTAT 5 CO2 Sensor with a patient circuit:

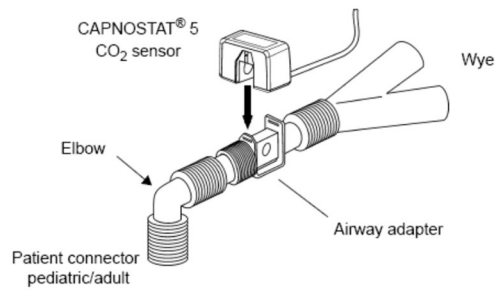

Connecting the LoFlo Sample Kit

1. The sample cell of the sampling kit must be inserted into the sample cell receptacle of the LoFlo CO₂ Module as shown in Figure 1. A "click" will be heard when the sample cell is properly inserted.

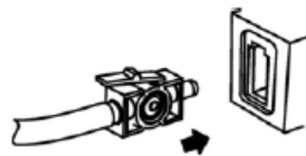

Figure 1

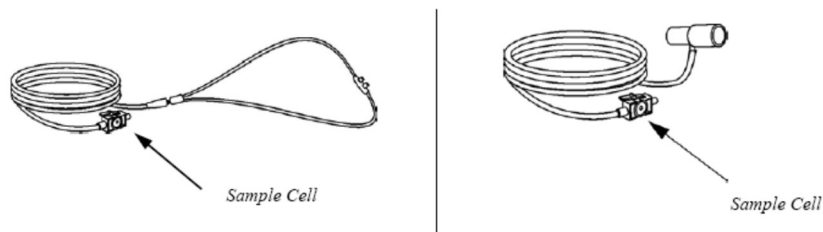

Figure 2

2. Inserting the sample cell into the receptacle automatically starts the sampling pump.

Removal of the sample cell turns the sample pump off.

3. To remove the sampling kit sample cell from the sample cell receptacle, press down on the locking tab and pull the sample cell from the sample cell receptacle.

Display

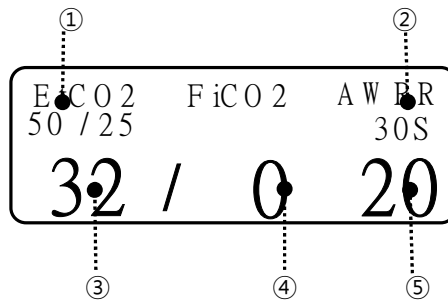

①	EtCO2 CO2 concentration alarm upper and lower limit value display
②	Apnea alarm set time in seconds
③	Display CO2 concentration value at exhalation
④	Display the carbon dioxide concentration value at inhalation
⑤	Show respiratory rate per minute

EtCO2 setup

A. EtCO2 menu		
Menu	Description	Available settings
A-1. Alarm	EtCO2 Alarm Setup Menu	
A-1-1. PARAMETER ALARM LIMIT	ETCO2, FICO2, AWRR, APNEA parameter alarm ,level , action setup menu	
A-1-2. TECHNICAL ALARM CONDITION	ETCO2-MODULE OFF ETCO2-CHECK ADAPTOR ETCO2-CHECK LINE ETCO2-CHEKC LINE DISCONNECT	

	<p>ETCO2-CO2 INVALID</p> <p>ETCO2-OVER RANGE</p> <p>ETCO2-ZERO REQUIRED</p> <p>ETCO2-SYSTEM FAULT</p> <p>ETCO2-TEMP UNSTABLE</p>	
A-2. DISPLAY OPTION	EtCO2 Parameter Wave Display Setup Menu	
A-2-1. SWEEP SPEED	Waveform sweep speed setup	6.25mm/s, 12.5mm/s, 25mm/s
A-2-2. SCALE	<p>Display waveform scale setup.</p> <p>The selectable value is the maximum pressure range shown in the waveform.</p> <p>When you select a range value, the selected pressure range value is displayed below the dotted line above the two dotted lines in the left middle of the WAVE window.</p>	<p>40mmHg (5.3 vol%)</p> <p>50mmHg (6.6 vol%)</p> <p>60mmHg (7.9 vol%)</p> <p>80mmHg (10.5 vol%)</p> <p>100mmHg(13.2vol%)</p> <p>150mmHg(19.7vol%)</p>
A-2-3. FILL	Choose whether to fill the waveform inside	ON/OFF
A-2-4. Gas Pressure Unit	Choose Gas Pressure Unit	mmHg kPa vol%
A-2-5. Use One Gas Unit	<p>Choose to set the pressure unit for each gas type</p> <p>Unit setting menu by gas type appears when OFF</p>	ON/OFF

A-3. APNEA DETECT	APNEA detection menu	ON/OFF
A-4. MODULE INFORMATION		
A-4-1. SENSOR PN	The sensor part number	PNXXXXXX
A-4-2. OEM ID	The id is a 7bit identifier which is set at the factory to a unique value for each OEM.	0X01
A-4-3. SENSOR SN	The serial number of the module.	
A-4-4. H/W VERSION	The hardware version number of the module.	
A-4-5. TOTAL USAGE TIME	Total use time of the module.	
A-4-6. LAST ZERO TIME	This is the total time that has elapsed with the sensor in service the last zero.	Min. display
A-4-7. PUMP TOTAL TIME	This is the total time the pump has been on.(LoFlo only)	Min. display
A-4-8. PUMP MAX TIME	This value indicates the maximum rated lifetime of the sampling pump. (LoFlo only)	Min. display
A-5. MODULE SETUP		
A-5-1. CURRENT PERIOD	This setting is used to set the calculation period of the ETCO ₂ value. The end-tidal CO ₂ value is the highest peak CO ₂ value of all end of expirations (end of breaths) over the selected time period. If less than two breaths exist in the selected time period, the value will be the maximum ETCO ₂ value for the last two breaths.	1 BREATH, 10SEC, 20SEC
A-5-2. BALANCE GAS	This setup mode to setup the gas in	ROOM AIR

	<p>the measurement.</p> <p>the type of gas that is mixed with the breathing gas measuring</p>	<p>N2O</p> <p>HELIUM</p>
A-5-3. SLEEP MODE	<p>Sleep mode is used to save power when the host monitor is in standby mode. There are two sleep modes available for the Capnostat. Using Sleep Mode 1 maintains the heaters so the Capnostat is able to run immediately after exiting the sleep mode. Mode 2 will require the Capnostat to go through its warm up sequence when exiting this mode and a delay will be introduced until the system has stabilized.</p>	<p>NORMAL MODE</p> <p>TURNOFF MODE</p> <p>POWER SAVING</p>
A-5-4. BARO. PRESSURE	<p>This setting is used to set current Barometric Pressure.</p>	<p>760mmHg</p>
A-5-5. GAS TEMPERATURE	<p>This setting is used to set temperature of the gas mixture. This setting is useful when bench testing using static gasses where the temperature is often room temperature or below.</p>	<p>35.0 °C</p>
A-5-6. O2 COMPENSATION	<p>Use this setting to correct for the compensation of the gas mixture administered to the patient.</p>	
A-5-7. ANESTHETIC AGENT	<p>Anesthetic agent is ignored when the balance gas is set to helium.</p>	
A-5-8. ZERO TYPE	<p>When performing a zero on room air, this setting should be set to room air</p>	<p>ROOM AIR</p> <p>N2</p>

	<p>(the default). Only change to nitrogen (N₂) when performing a zero on 100% N₂ gas; this is provided for use in a laboratory environment.</p>	
<p>B-1. ZEROING</p>	<p>This function is used to initiate a Capnostat Zero.</p> <p>A zero is used to correct for differences in airway adapter types.</p> <p>The Capnostat zero must be performed free of any CO₂</p> <ol style="list-style-type: none"> 1. Set the Host to the zeroing function. 2. Connect the CAPNOSTAT 5 CO₂ Sensor 3. Place the CAPNOSTAT 5 CO₂ Sensor onto a clean and dry CO₂ adapter that is exposed to room air and away from all sources of CO₂, including the ventilator, the patient's breath and your own. <p>Start the adapter zero. The maximum time for a CAPNOSTAT zero is 40seconds. The typical time for a zero is 15~20seconds.</p>	
<p>C-1. MODULE RESET</p>	<p>EtCO₂ MODULE initializing.</p>	

Note

For best result, connect the CAPNOSTAT 5 CO2 Sensor to an adapter and wait 2minutes before performing the Adapter Zero procedure.

Status Message

Following is a list of some of the message that may appear on the monitor when monitoring CO2. The message should clear when normal operating criteria are met or a solution is found.

*** SENSOR OVER TEMP**

- Cause : The sensor temperature is greater than 40'C
- Solution : Make sure sensor is not exposed to extreme heat(heat lamp,etc.)

*** SENSOR FAULTY**

- Cause: One of the following conditions exist : Capnostat Source Current Failure
EEPROM Checksum Faulty , Hardware Error
- Solution : Check that the sensor is properly plugged in. Reinsert or reset the sensor if necessary.

*** SENSOR WARM UP**

- Cause : Sensor under temperature , Temperature not stable, Source Current unstable
- Solution : This error condition is normal at startup. This error should clear when the warm up is complete.

*** CHECK SAMPLING LINE**

- Cause : This error occurs whenever the pneumatic pressure is outside the expected range.
- Solution : Check that the sampling line is not occluded or kinked. Replace the sample line

*** ZERO REQUIRED**

- Cause : Zero Required , Zero Error
- Solution : To clear, check airway adapter and clean if necessary. If this does not correct the error, perform an adapter zero. If you must adapter zero more than once, a possible hardware error may exist.

*** CO2 OUT OF RANGE**

- Cause : The value being calculated is greater than the upper CO2 limit(150mmHg)
- Solution : If error persists, perform a zero.

*** CHECK AIRWAY ADAPTER**

- Cause: Usually caused when the airway adapter is removed from the Capnostat or when there is an optical blockage on the windows of the airway adapter. May also be caused by failure to perform Capnostat zero to when adapter type is changed.
- Solution: To clear, clean airway adapter if mucus or moisture is seen. If the adapter is clean, perform a Capnostat zero.

message	status	solution
MODULE OFF	It occurs when the equipment and module are separated. Message output	Verify module connections Service request

CO2 measurement failure

CO2 value is not output, or numerical error.

Troubleshoot procedure

1. Check the connection between the main unit and the module
2. Check the module line connection with the filter line or airway
3. Replace filter line or airway
4. Service Request

Note

In the following monitoring conditions, the measured values may be inaccurate. Read the measured values carefully.

1. When using this in an environment of using nitrous oxide gas of high concentration
2. When using this in an environment where abrupt temperature change takes place
3. When using this in an environment with severely high humidity.

Caution

- The measured values may be inaccurate when using this equipment for patients who have very fast or irregular respiration.
- When measuring CO₂ from the patient under the anesthesia, check it when gas mixture comes in. Otherwise, the measured result values may be inaccurate.
- When using an anesthesia machine that uses a volatile anesthetic, CO₂ values may be inaccurate.

13. Temperature

Overview

This function is used to indicate the changes of resistance generated by the changes of temperature in numbers. The function involves the process of transferring the changes into electric signals.

Temperature Connector and Measuring Cable

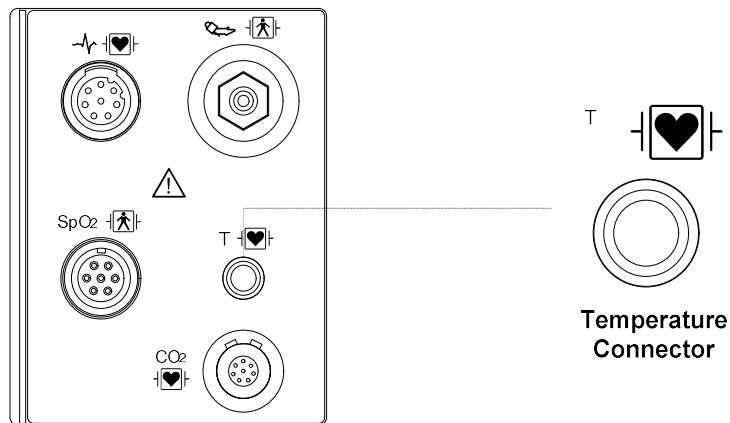

Temperature measuring Cable



Note

Temperature probe is correctly positioned and fixed to do not disconnect on the patient. Temperature cable is attached to the monitor.

Display

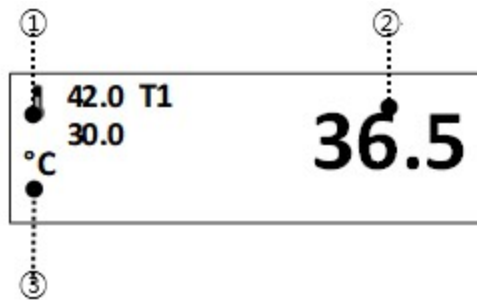

①	Temperature alarm limit display
②	Temperature value display
③	Temperature unit display

Note

The minimum measuring time required to obtain accurate readings at the specific body site is at least 3minutes.

If the measurement site is directly exposed to air, the temperature may be lower than normal.

It takes about 20 ~ 30minutes to reach temperature equilibrium by attaching this sensor.

Warning

To measure the ambient temperature, connect the probe to your ankle or wrist.
 If the patient is sweating or moving heavily, fix the pads with surgical tape.

Temperature settings

A. Temp menu		
MENU	Description	Available Settings
A-1. Alarm	Temp Alarm Settings menu	
A-1-1. PARAMETER ALARM LIMIT	TEMP1 Parameter Alarm level , Action setup menu Settings range from 0°C to 50.0°C/ 32° F to 122°F.	
A-1-2. TECHNICAL ALARM CONDITION	TEMP1-PROBE OFF	

14. Printer

Overview

The monitor in order to print out monitoring data, including trends and alarm data. Recordings of waveforms are either timed or continuous and print at a recording speed of 25mm/s. All recordings are identified by the patient's name, ID as well as the date and time of the recording request. The monitor can trigger alarm recordings automatically for life-threatening alarms and limit violations, if the Record function is enabled on the alarm limits table.

A printer used to print data onto thermal paper.

Size of the thermal paper roll: 58mm wide x 38mm in diameter any thermal paper of same size can be used for the printer.

Side view of printer



Caution

- Due to the nature of thermal paper, it generates heat when continuously output, so it is recommended to output after 5minutes of output and after 10minutes of idle time.

Printer settings

Menu	Description	Available settings
A. Print Setup menu		
A-1. Printer Setup		
A-1-1. Use Of Printer	PRINTER activation menu	ON / OFF
A-1-2. Printer Speed	Printer speed can select between 25 and 50mm/s.	25 mm/s 50 mm/s
A-1-3. Waveform1	Channel 1 waveform select menu	OFF, SPO2, RESP, ETCO2, ECG
A-1-4. Waveform2	Channel 2 waveform select menu	
A-1-5. Waveform3	Channel 3 waveform select menu	
A-1-6. Print From Time	<p>This is configuration of printed time in normal printing.</p> <p>If the print out is not stopped in manual by PRINTER KEY, BM3 print out for setup time after starting print out with PRINTER KEY.</p> <p>REAL TIME: Prints the data from the point where the PRINTER key was pressed.</p>	Real Time Delay (5sec)

	DELAY: Prints data before 5seconds when PRINTER key is pressed	
A-1-7. Time Interval	Set the time for printing the printout on normal printout. If you do not stop manually after pressing the PRINTER KEY, the output will be output only for the following period of time.	Continue, 10sec, 20sec, 30sec

Thermal Paper Storage

To avoid print quality degradation or attenuation of printouts, follow these precautions:

Note
These precautions apply to both unused paper as well as paper that has already been run through the printer.

- Store in cool, dark locations. Temperature must be below 27°C (80°F). Relative humidity must be between 40% and 65%.
- Avoid exposure to bright light or ultraviolet sources such as sunlight, fluorescent, and similar lighting which causes yellowing of paper and fading of tracings.
- AVOID CONTACT WITH: cleaning fluids and solvents such as alcohols, ketones, esters, ether, etc.
- DO NOT STORE THERMAL PAPER WITH ANY OF THE FOLLOWING:
 - Carbon and carbonless forms.
 - Non-thermal chart papers or any other products containing tributyl phosphate, dibutyl phthalate, or any other organic solvents. Many medical and industrial charts contain these chemicals.
 - Document protectors, envelopes, and sheet separators containing polyvinyl chloride or other vinyl chlorides.
- DO NOT USE: mounting forms, pressure-sensitive tapes or labels containing solvent-based adhesives.

To assure MAXIMUM TRACE IMAGE LIFE, thermal paper should be stored separately in: manilla folders, polyester or polyimide protectors.

Plastic document protectors, envelopes, or sheet separators made of polystyrene, polypropylene, or polyethylene will not degrade thermal traces in themselves. However, these materials afford no protection against fading from external causes.

Paper manufacturers advise us that these thermal products should retain their traces

when properly imaged and stored for about 3-5 years.

If your retention requirements exceed these guidelines, we recommend you consider alternate image storage techniques.

Paper Change

1

Open the window of the printer.



2

Insert the paper roll offered with the product into the printing unit. Place the roll in a proper way so that the printed paper can roll out upwards.



3

Press the printer window until it is properly shut. Inaccurate shutting may cause failure in printing.



15. Maintenance and Troubleshooting

Inspection Equipment

You should perform a visual inspection before every use, and in accordance with your hospital's policy. With the monitor switched off:

- Examine unit exteriors for cleanliness and general physical condition. Make sure that the housings are not cracked or broken, that everything is present, that there are no spilled liquids and that there are no signs of abuse.
- If the EtCO₂ module is mounted on the monitor, make sure that they are locked into place and do not slide out without releasing the locking mechanism.
- Inspect all accessories (cables, transducers, sensors and so forth). If any show signs of damage, do not use.

Switch the monitor on and make sure the backlight is bright enough. Check that screen is at its full brightness. If the brightness is not adequate, contact your service personnel or your supplier

Warning

Use of this equipment adjacent to or stacked with other equipment should be avoided because it could result in improper operation. If such use is necessary, this equipment and the other equipment should be observed to verify that they are operating normally

Inspection Cables

- Examine all system cables, the power plug for damage. Make sure that the prongs of the plug do not move in the adaptor. If damaged, replace it with an appropriate Bionet power cord and adaptor.
- Inspect the parameter cable and ensure that it makes good connection with the

Monitor. Make sure that there are no breaks in the insulation.

- Apply the transducer or electrodes to the patient, and with the monitor switched on, flex the

Patient cables near each end to make sure that there are no intermittent faults

Warning
To avoid contaminating or infecting personnel, the environment or other equipment, make sure you disinfect and decontaminate the monitor appropriately before disposing of it in accordance with your country's laws for equipment containing electrical and electronic parts. For disposal of parts and accessories such as thermometers, where not otherwise specified, follow local regulations regarding disposal of hospital waste.

Maintenance Task and Test Schedule

All maintenance tasks and performance tests are documented in detail in the service documentation

Maintenance and Test Schedule	Frequency
Monitor Tests	
Safety checks. Selected tests on the basis of IEC 60601-1	At least once every two years, or as needed, after any repairs where the power supply is removed or replaced, or if the monitor has been dropped
Monitor Maintenance	
Check ECG synchronization of the monitor and defibrillator (only if hospital protocol requires use of monitor during defibrillation)	At least once every two years, or as needed.
Replace backlight (integrated displays only)	35,000 - 40,000 hours (about four years) of continuous usage, or as needed.

Parameter Module Tests	
Performance assurance for all measurements not listed below.	At least once every two years, or if you suspect the measurement values are incorrect.
Parameter Module Maintenance	
NBP calibration	At least once every two years, or as specified by local laws.
Mainstream and sidestream CO ₂ calibration check	At least once a year, or if you suspect the measurement values are incorrect.
Battery Maintenance	
Battery	See this section on Maintaining Batteries in chapter 1.

Noise in ECG

- Gel is dry
- Electrodes does not stick well to skin

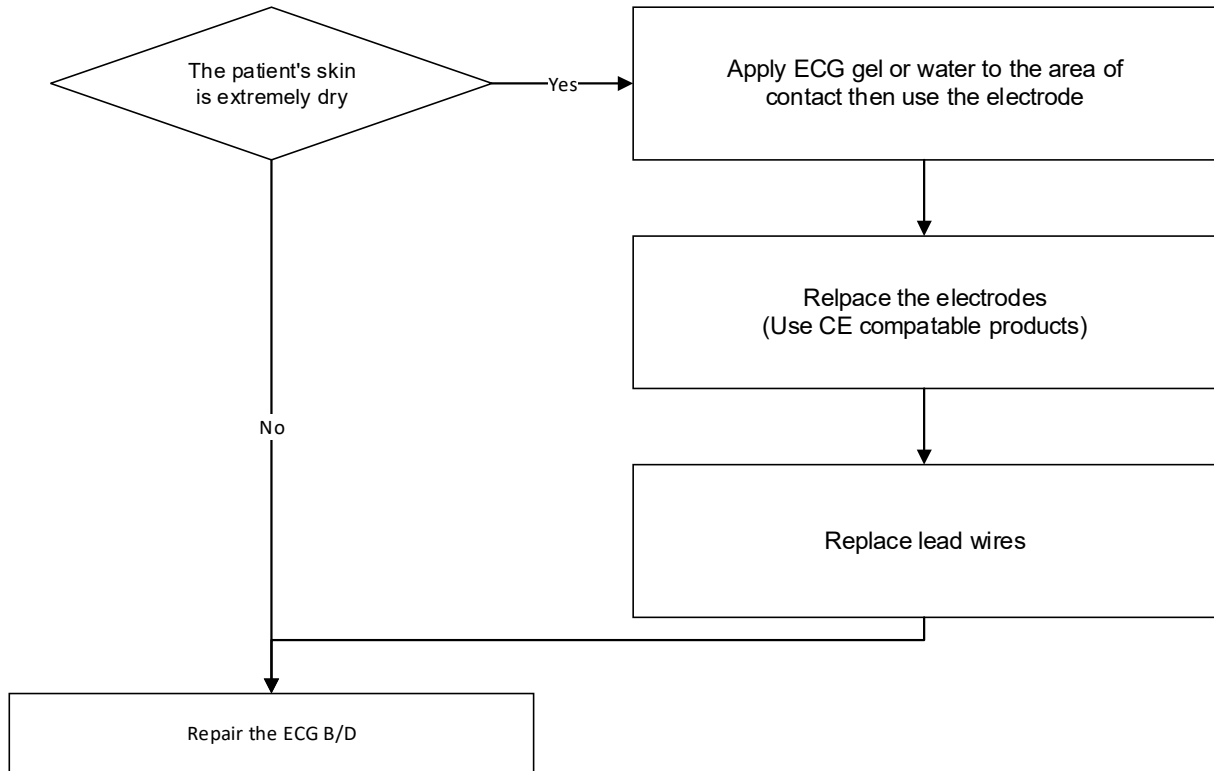

SpO2 malfunction

Connectors of the equipment's are in bad condition?

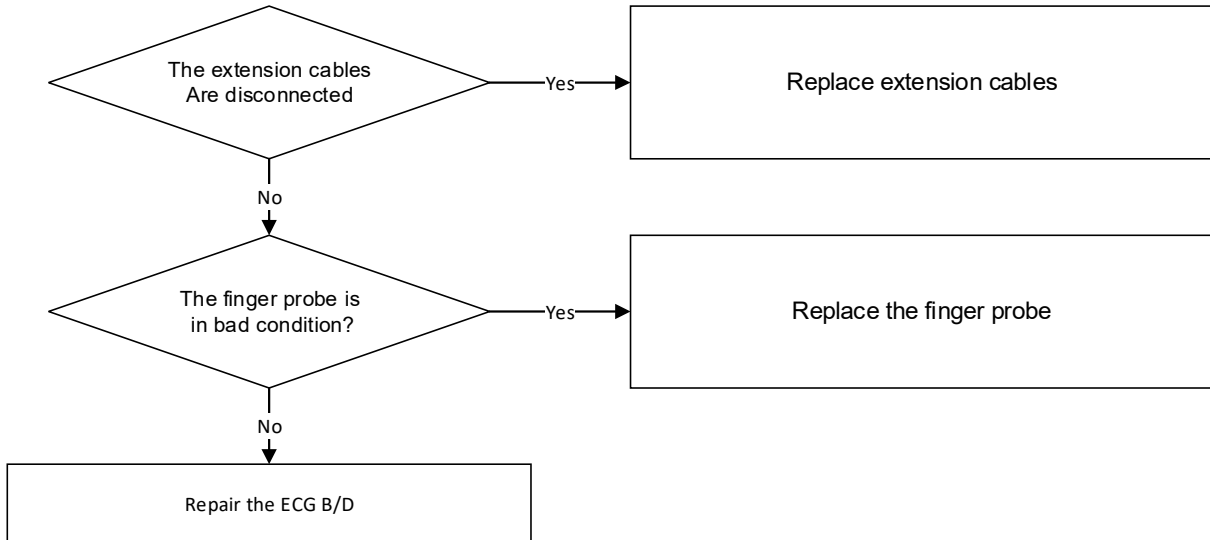

Temperature malfunction

- If the temperature cannot be measured, check the connection with the equipment

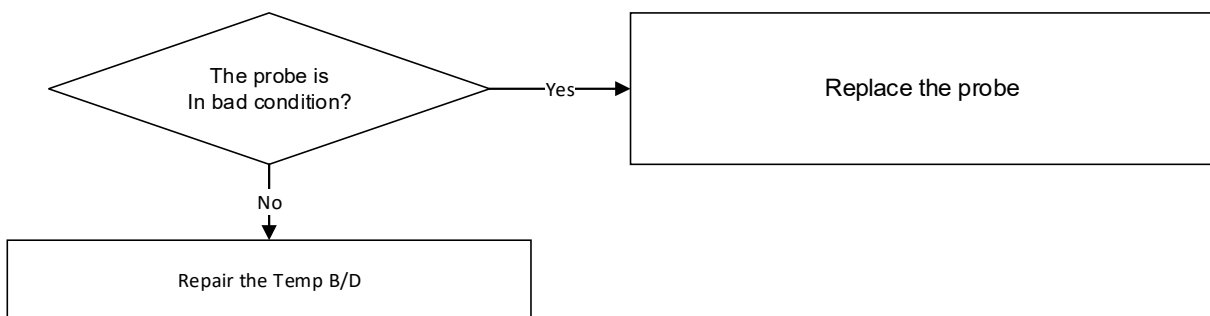

NIBP malfunction

- Connector connection status, confirmation that the hose is normally connected

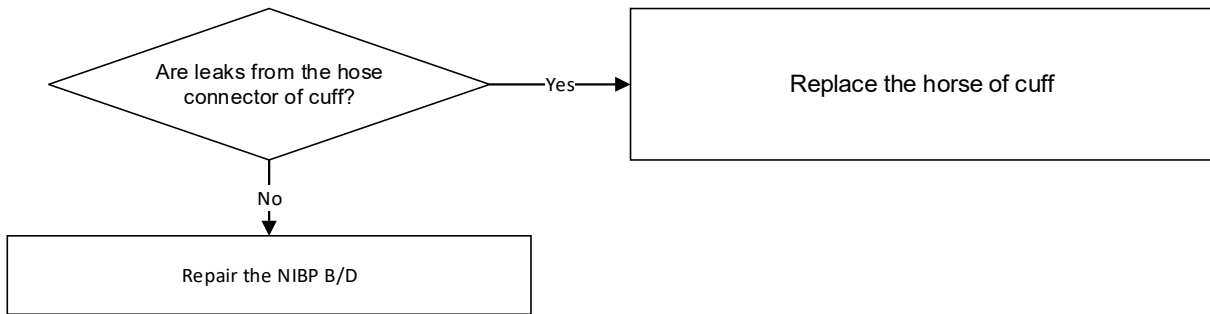

Abnormality in NIBP measurements

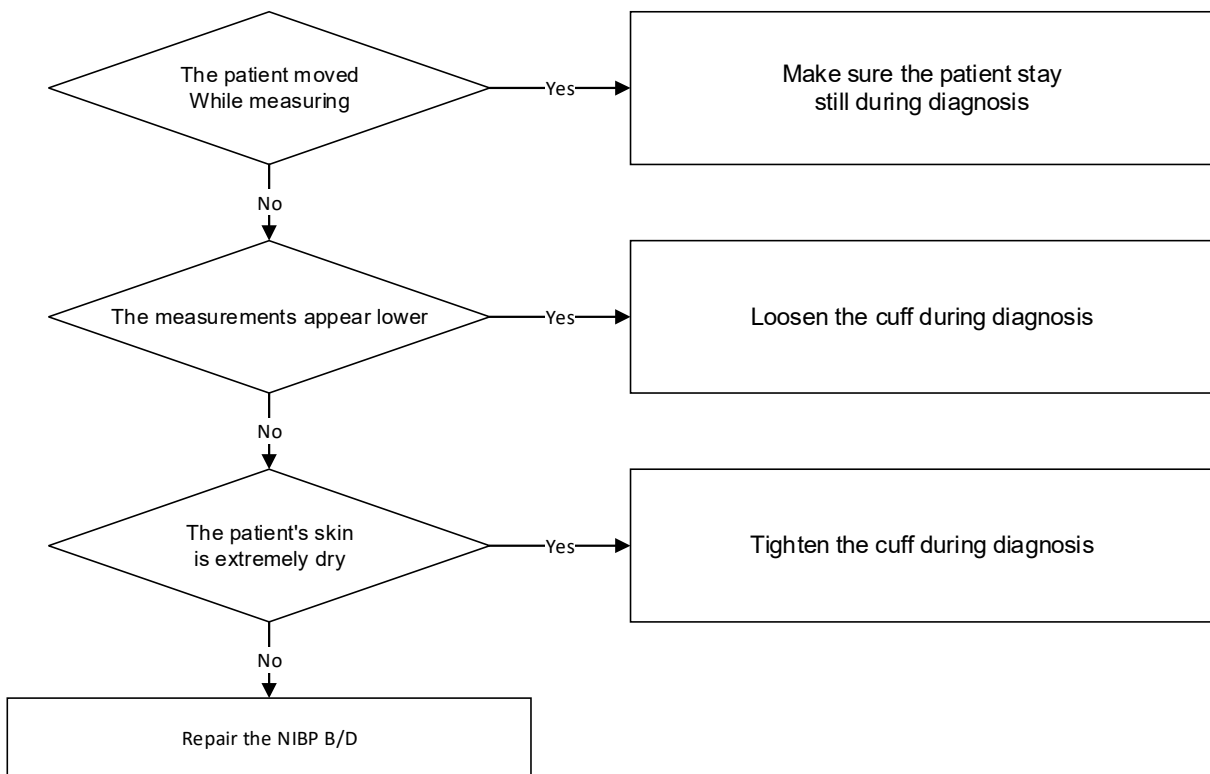

EtCO2 malfunction

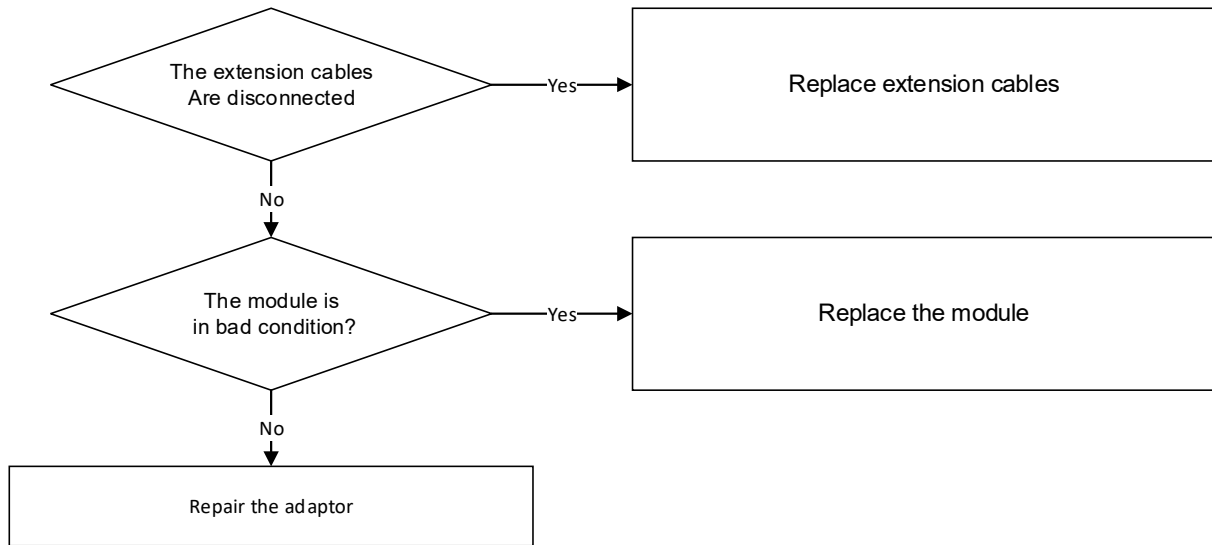

Failure in battery recharge

(the battery does not fully recharge in 6 hours or more)

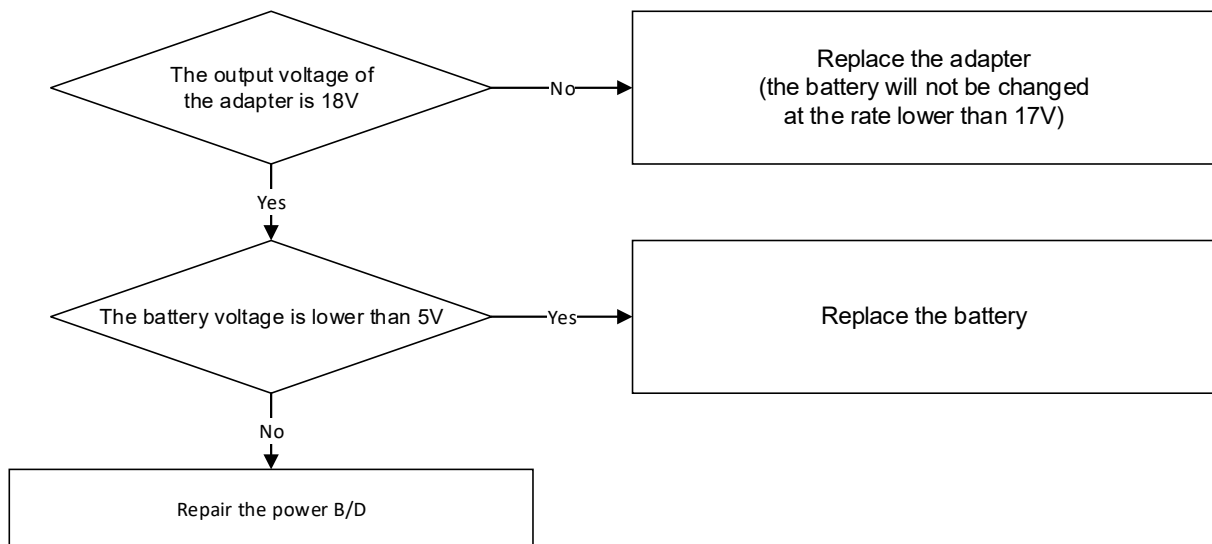

Power failure

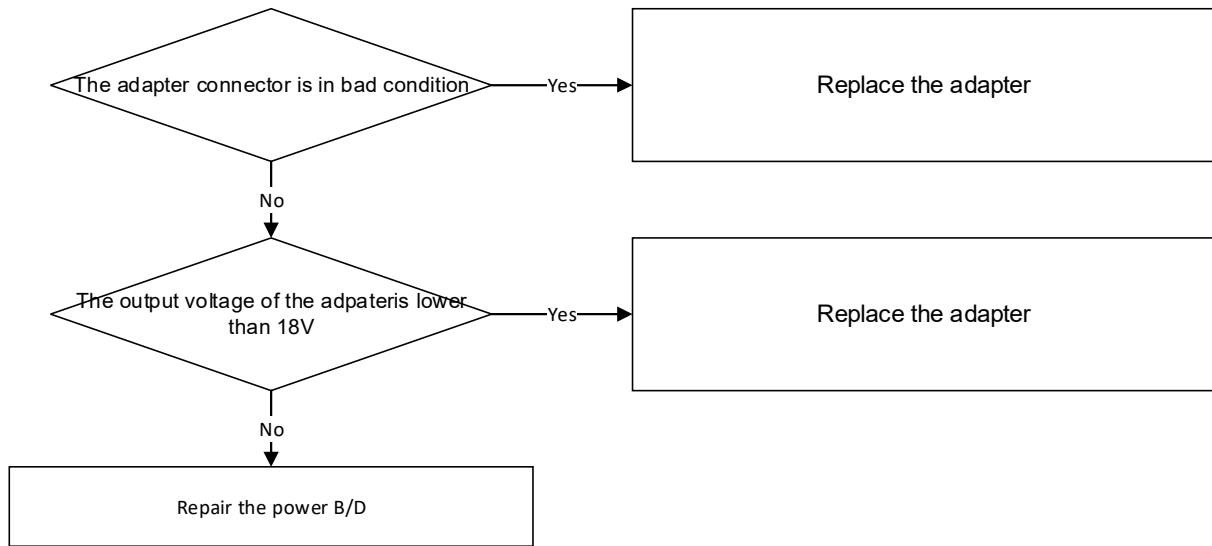

Data storage failure

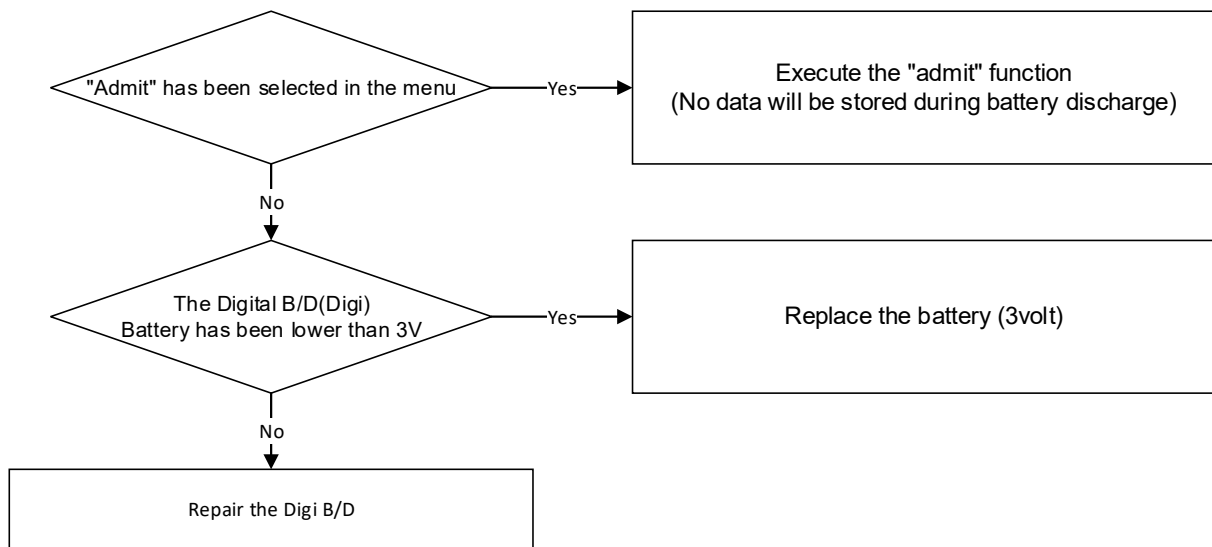

Periodic noises

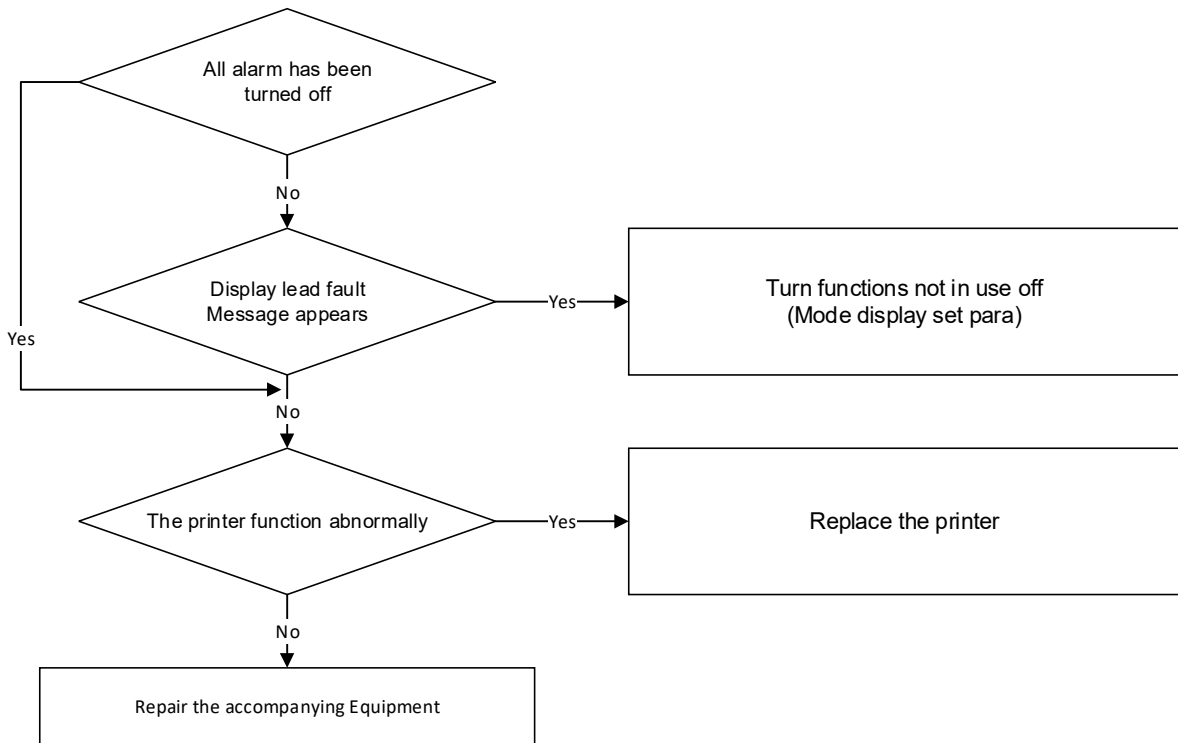

Print failure

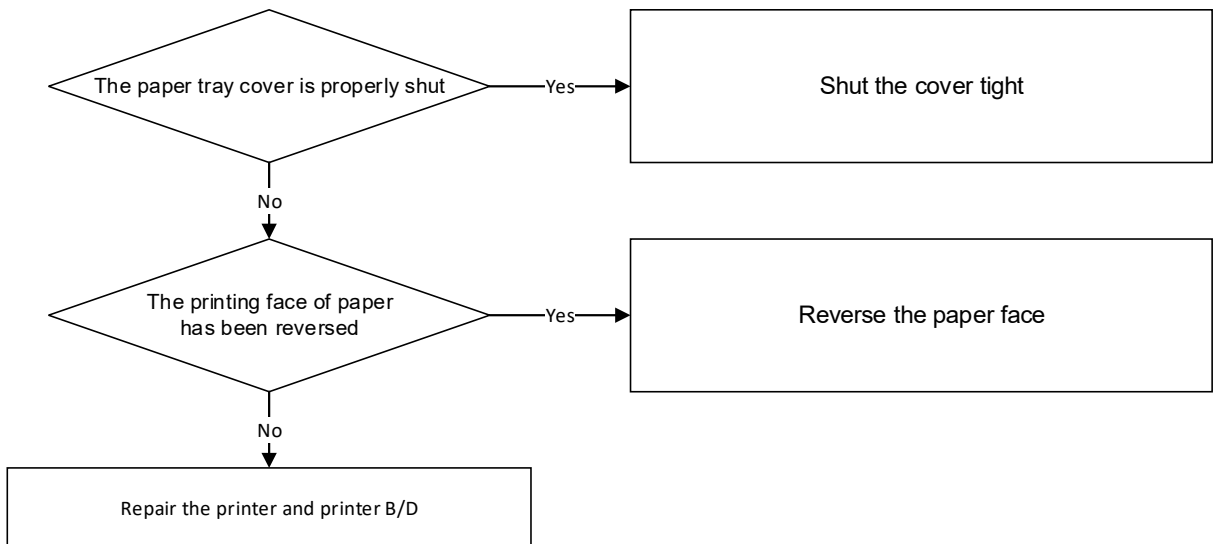

16. Clean and Care

Overview

Clean the monitor and all accessories after each patient or daily according to your hospital's standard protocol. We recommend the following cleaning solution and procedures. To avoid contamination and unnecessary damage to the equipment, follow the instructions below.

Bionet does not claim the right to the following chemical efficacy, disinfectant method, the ability of the drug to inhibit bacterial infection, environmental impact, safe handling or precautions related to use. For more information on these topics, see the information provided by the detergent manufacturer.

Monitor and Peripherals

Moisture can damage the monitor and peripherals. (For example, around connectors, EtCO₂ modules).

Please read the following instructions carefully before cleaning the basic unit or peripherals.

The following pages contain precautions for cleaning certain equipment and peripherals.

- Do not spray detergent on the monitor or peripheral devices. Wipe it off with a damp cloth.
- Disinfect the surface with gauze with diluted alcohol.
- Dry thoroughly with a lint-free cloth.

CAUTION

Do not wet or rinse the monitor and accessories. Disconnect the unit from the power source if you accidentally spilled liquid on the equipment. Contact your technician for stability before operating the equipment.

To prevent damage to the equipment, do not use sharp tools or abrasives. Never immerse the electrical connector in water or other liquids. When cleaning, be careful not to let the

liquid stick to the edge of the screen.

Patient's Cable

- Clean the patient cables with a gauze pad moistened with a soap solution.
- To disinfect patient cables, wipe the cables with a gauze moistened with diluted alcohol or a glutaraldehyde-based disinfectant.
- Ethylene oxide is suitable for intensive disinfection (almost sterilization), but it shows that the service life of cables and lead wires is reduced.
- Dry thoroughly with a lint-free cloth.

CAUTION

Do not use disinfectants that contain phenol as they can spot plastics. Do not autoclave or clean accessories with strong aromatic, chlorinated, ketone, ether, or ester solvents. Never immerse electrical connectors.

When cleaning, do not apply excessive pressure or bend the cable unnecessarily. Excessive pressure can damage the cable.

Reusable ECG Electrodes

Clean the electrode cup regularly with a toothbrush. When removing gel-like residues, use a soft brush with flowing water. Wipe the electrode with a soapy cloth moistened with soapy water.

- Sterilize the electrode by soaking the diluted alcohol in cloth.
- Dry thoroughly with a lint-free cloth.

Reusable SpO2 sensor

Reuse Clean the SpO2 sensor by wiping it with soapy water gauze. Disinfect the sensor by wiping with 70% alcohol solution. Allow the patient to dry completely with a lint-free cloth before applying to the patient.

Capnostat sensor

Wipe the sensor surface and sensor window with a damp cloth. Do not attempt to wet the sensor or disinfect it with hot water. Allow to dry completely with a lint-free cloth. Make sure the sensor window is clean and dry before use.

Reusable Temperature probes and cables

Do not use excessive pressure or flex the cables as this can stretch the covering and break the internal wires.

- Clean the probes with a 3% hydrogen peroxide or 70% alcohol.
- Quickly immerse the cables in a detergent solution.
- Make sure the probe's tip is firmly connected.

CAUTION

Never boil or autoclave the cable. Vinyl withstands temperatures up to 100°C but begins to soften at around 90°C. Handle gently when hot and wipe away from the tip toward the cable.

CAUTION

Decisions on disinfection should be made by the user organization in accordance with the integrity of the wires or lead wires.

Note

The equipment should be inspected regularly once a year. For inspection items, refer to the user manual or service manual.

Carefully inspect the main unit and sensor after cleaning the equipment. Do not use damaged or old equipment.

Clean the exterior of the equipment at least once a month using a soft cloth moistened with lukewarm water or alcohol. Do not use lockers, thinners, ethylene, or oxidizers that could damage the equipment.

Make sure that the cables and accessories are free from dust and dirt, then wipe them with a soft cloth moistened with 40 ° C water. Please wipe it with clinical alcohol at least once a week.

Do not immerse the accessory in liquid or detergent. Also, make sure that no liquid penetrates the instrument or probe.

Caution

Do not dispose of the disposable probe in a potentially hazardous area.
Always be careful about environmental pollution.

Caution

There is a backup battery inside the system.
When disposing of the battery, dispose of it in an appropriate place for environmental protection.

Warning

When replacing the backup battery, check the battery electrode.

·If you suspect the installation or disposition of the external ground wire, operate the equipment by means of the internal power supply.

·If the unit is not used for a certain period of time, remove the backup battery if safety hazards do not occur.

17. Technical Specification

Overview

The monitor is not user installable. It must be installed by qualified service personnel.

The monitor is intended to be used for monitoring, recording, and alarming of multiple physiological parameters of adults, pediatrics, and neonates in health care facilities. The device is to be used by trained health care professionals.

The monitor is intended for use in health care facilities; the BM3 Monitor is additionally intended for use in transport situations within the hospital setting.

EMC Compatibility (EMC)

Much of the information below has been borrowed from the requirements set forth in the Electromagnetic Compatibility Standard IEC 60601-1-2 for medical electrical equipment issued by the International Electro technical Commission and is available from a variety of sources. Although primarily aimed at equipment manufacturers, most of the information contained here is useful for users interested in medical equipment.

The information contained in this section (such as separation distance) is generally information about the Bionet Patient Monitor detailed above. The numbers provided here are not guaranteed, but are provided with reasonable assurance of error-free operation. This information may not apply to other medical and electrical systems, and older equipment may be particularly susceptible to interference.

Note

- Medical electrical equipment requires special precautions for electromagnetic compatibility and must be installed and serviced in accordance with the EMC information in this section and in the operating instructions supplied with the monitor.
- Portable and mobile RF communication equipment can affect medical electrical equipment.
- Cables and accessories not specified in the user guide are not certified. Using other cables and / or accessories may adversely affect safety, performance, and electromagnetic compatibility (increased electromagnetic emissions and reduced immunity).
- This equipment should not be used near or on top of other equipment. If you need to

use it on its side or stacked, you should observe the equipment to make sure it works properly within your configuration.

- This patient monitoring device communicates over a 2.4 GHz 802.11b / g wireless network. Other equipment may interfere with data reception on this wireless network. This is also true if the equipment complies with the CISPR emission requirements. When using patient monitoring equipment to communicate over a wireless network, be sure to check that it is compatible with existing or new wireless systems (eg, cell phones, pager systems, cordless phones, etc.). For example, a Bluetooth-compliant device using the 2.4 GHz frequency band may interfere with the wireless communication of the patient monitor. For more information on wireless deployment, please contact your Bionet representative.

- Low amplitude signals such as EEG and ECG are particularly sensitive to interference from electromagnetic energy. This equipment complies with the tests listed at the bottom, but does not guarantee complete operation. The "quiet" electrical environment is better. In general, the greater the distance between electrical equipment, the lower the likelihood of interference.

Manufacturer's declaration - electromagnetic emission

The BM3 system is intended for use in the electromagnetic environment specified below. The customer or the user of BM3 system should assure that it is used in such an environment		
Emission test	Compliance	Electromagnetic environment - guidance
RF emissions CISPR 11	Group 1	The BM3 system is suitable for use in all establishments other than domestic and those directly connected to the public low-voltage power supplies buildings used for domestic purposes.
RF emissions CISPR 11	Class A	
Harmonics emission IEC 61000-3-2	A	
Voltage fluctuation IEC 61000-3-3	Complies	

Manufacturer's declaration - electromagnetic immunity

<p>The BM3 system is intended for use in the electromagnetic environment specified below.</p> <p>The customer or the user of the BM3 system should assure that it is used in such an environment</p>			
Immunity test	IEC 60601 Test level	Compliance level	Electromagnetic Environment -guidance
Electrostatic discharge (ESD) IEC 61000-4-2	6 kV Contact 8 kV Air	6 kV Contact 8 kV Air	Floors should be wood, concrete or ceramic tile. If floors are covered with synthetic material, the relative humidity should be at least 30 %
Electrical fast Transient / burst IEC 61000-4-4	2kV for power supply lines 1kV for input/output lines	2kV for power supply lines 1kV for input/output lines	Mains power quality should be that of a typical commercial or hospital environment.
Surge IEC 61000-4-5	1 kV differential mode 2 kV common mode	1 kV differential mode 2 kV common mode	Mains power quality should be that of a typical commercial or hospital environment.
Power frequency (50/60Hz) Magnetic field IEC 61000-4-8	3.0 A/m	3.0 A/m	Power frequency magnetic fields should be at levels characteristic of a typical location in a typical commercial or hospital environment.

<p>Voltage dips, short Interruptions and Voltage variations on power supply input lines IEC 61000-4-11</p>	<p><5% U_T (>95% dip in U_T) for 0.5cycle</p> <p>40% U_T (60% dip in U_T) for 5 cycle</p> <p>70% U_T (30% dip in U_T) for 25 cycle</p> <p><5% U_T (<95% dip in U_T) for 5 s</p>	<p><5% U_T (>95% dip in U_T) for 0.5cycle</p> <p>40% U_T (60% dip in U_T) for 5 cycle</p> <p>70% U_T (30% dip in U_T) for 25 cycle</p> <p><5% U_T (<95% dip in U_T) for 5 s</p>	<p>Mains power quality should be that of a typical commercial or hospital environment. If the user of the BM3 system requires continued operation during power mains interruptions, it is recommended that the BM7 system be powered from an uninterruptible power supply or a battery</p>
--	---	---	---

Note: U_T is the a.c. mains voltage prior to application of the test level.

The **BM3** system is intended for use in the electromagnetic environment specified below.

The customer or the user of the **BM3** system should assure that it is used in such an environment

Immunity test	IEC 60601 Test level	Compliance level	Electromagnetic environment -guidance
Conducted RF IEC 61000-4-6	3 Vrms 150 kHz to 80 MHz	3 Vrms 150 kHz to 80 MHz	<p>Portable and mobile RF communications equipment should be used no closer to any part of the BM3 system, including cables, than the recommended separation distance calculated from the equation applicable to the frequency of the transmitter.</p> <p align="center">Recommended separation distance</p> $d = \left[\frac{3,5}{V_1} \right] \sqrt{P}$

<p>Radiated RF IEC 61000-4-3</p>	<p>3 V/m 80.0 MHz to 2.5 GHz</p>	<p>3 V/m 80.0 MHz to 2.5 GHz</p>	<p>Recommended separation distance</p> $d = \left[\frac{3,5}{E_1} \right] \sqrt{P} \quad 80 \text{ MHz to } 800 \text{ MHz}$ $d = \left[\frac{7}{E_1} \right] \sqrt{P} \quad 800 \text{ MHz to } 2,5 \text{ GHz}$ <p>Where P is the maximum output power rating of the transmitter in watts (W) according to the transmitter manufacturer and d is the recommended separation distance in meters (m).</p> <p>Field strengths from fixed RF transmitters, as determined by an electromagnetic site survey,</p> <p>(a) Should be less than the compliance level in each frequency range (b).</p> <p>Interference may occur in the vicinity of equipment marked with the following symbol:</p> 
<p>Note 1) U_T is the A.C. mains voltage prior to application of the test level.</p> <p>Note 2) At 80 MHz and 800 MHz, the higher frequency range applies.</p> <p>Note 3) These guidelines may not apply in all situations. Electromagnetic propagation is affected by absorption and reflection from structures, objects and people.</p>			

a Field strengths from fixed transmitters, such as base stations for radio (cellular/cordless) telephones and land mobile radios, amateur radio, AM and FM radio broadcast and TV broadcast cannot be predicted theoretically with accuracy. To assess the electromagnetic environment due to fixed RF transmitters, an electromagnetic site survey should be considered. If the measured field strength in the location in which the EUT is used exceeds the applicable RF compliance level above, the EUT should be observed to verify normal operation. If abnormal performance is observed, additional measures may be necessary, such as re-orienting or relocating the EUT.

b Over the frequency range 150 kHz to 80 MHz, field strengths should be less than [V1] V / m.

Recommended Separation Distances Between Portable and Mobile RF Communications Equipment and the **BM3** system.

The **BM3** system is intended for use in an electromagnetic environment in which radiated RF disturbances are controlled. The user of the **BM3** system can help prevent electromagnetic interference by maintaining a minimum distance between portable and mobile RF communications equipment (transmitters) and the BM3 system as recommended below, according to the maximum output power of the communications equipment.

Rated maximum output power (W) of transmitter	Separation distance (m) according to frequency of transmitter		
	150 kHz to 80 MHz	80 MHz to 800 MHz	800 MHz to 2.5 GHz
0.01	0.12	0.12	0.23
0.1	0.37	0.37	0.74
1	1.17	1.17	2.33
10	3.70	3.70	7.37
100	11.70	11.70	23.30

For transmitters rated at a maximum output power not listed above, the recommended separation distance (d) in meters (m) can be estimated using the equation applicable to the frequency of the transmitter, where P is the maximum output power rating of the transmitter in watts (W) according to the transmitter manufacturer.

Note 1: At 80 MHz and 800 MHz, the separation distance for the higher frequency range applies

Note 2: These guidelines may not apply in all situations. Electromagnetic propagation is affected by absorption and reflection from structures, objects, and people.

Immunity and Compliance Level			
Immunity test	IEC 60601 Test Level	Actual Immunity Level	Compliance Level
Conducted RF IEC 61000-4-6	3 Vrms, 150 kHz to 80 MHz	3 Vrms, 150 kHz to 80 MHz	3 Vrms, 150 kHz to 80 MHz
Radiated RF IEC 61000-4-3	3 V/m, 80 MHz to 2.5 GHz	3 V/m, 80 MHz to 2.5 GHz	3 V/m, 80 MHz to 2.5 GHz

Guidance and manufacturer's declaration - electromagnetic immunity

The **BM3** system is intended for use in the electromagnetic environment specified below.

The customer or the user of the **BM3** system should assure that it is used in such an environment

Immunity test	IEC 60601 Test level	Compliance level	Electromagnetic environment -guidance
Conducted RF IEC 61000-4-6	3 Vrms 150 kHz to 80MHz z	3 Vrms 150 kHz to 80 MHz z	BM3 system must be used only in a shielded location with a minimum RF shielding effectiveness and, for each cable that enters the shielded location with a minimum RF shielding effectiveness and, for each cable that enters the shielded location
Radiated RF IEC 61000-4-3	3 V/m 80.0 MHz to 2.5 GHz	3 V/m 80.0 MHz to 2.5 GHz	Field strengths outside the shielded location from fixed RF transmitters, as determined by an electromagnetic site survey, should be less than 3V/m.a Interference may occur in the vicinity of equipment marked with the following symbol: 

Note 1) These guidelines may not apply in all situations. Electromagnetic propagation is affected by absorption and reflection from structures, objects and people.

Note 2) It is essential that the actual shielding effectiveness and filter attenuation of the shielded location be verified to assure that they meet the minimum specification.

a- Field strengths from fixed transmitters, such as base stations for radio (cellular/cordless) telephones and land mobile radios, amateur radio, AM and FM radio broadcast and TV broadcast cannot be predicted theoretically with accuracy. To assess the electromagnetic environment due to fixed RF transmitters, an electromagnetic site survey should be considered. If the measured field strength outside the shielded location in which the EUT is used exceeds 3V/m, the EUT should be observed to verify normal operation.

If abnormal performance is observed, additional measures may be necessary, such as relocating the EUT or using a shielded location with a higher RF shielding effectiveness and filter attenuation.

Note

For Type A Professional ME Equipment intended for use in domestic establishment instructions for use includes a warning:

This ME equipment is intended for use by professional healthcare personnel only.

Warning

Portable RF communications equipment (including peripherals such as antenna cables and external antennas) should be used no closer than 30 cm (12 inches) to any part of the [ME EQUIPMENT or ME SYSTEM], including cables specified by the manufacturer

Warning

Use of accessories and cables other than those specified or provided by the manufacturer of this equipment could result in increased electromagnetic emissions or decreased electromagnetic immunity of this equipment and result in improper operation

System Specification

Physical

Dimension (H x W x D)	250 x 238 x 163 mm
Weight	Approx. 3.1kg
Indicator	3 LED
Cooling	Air flow
Interface	RJ45 , USB , HDMI
Power	AC 100-240V (50/60Hz) Adapter 18 V, 2.8 A
Power consumption	< 50Watts
Operating Mode	Continuous

Environments

Temperature	Operating : 5 ~ +40 °C (41 ~ 104 °F)
	Storage : -20 ~ +60 °C (-4 ~ +140 °F)
Humidity	Operating: 30% ~ 85%,
	Storage: 10% ~ 95% (PACKAGE)
Operating Attitude	Operating : 525 ~ 795 mmHg (70 ~ 106 kPa)
	Storage : 375 ~ 795 mmHg (50 ~ 106 kPa)
Display	TFT-LCD
Resolution	800 X 600
Display size	8"
Measurement Parameter	ECG, Heart Rate, Respiration Rate, SpO2, Pulse Rate, Systolic BP, Diastolic BP, Mean BP, Temperature, EtCO2, FiCO2, Airway Respiration Rate
TRACE	4 waveforms : 2*ECG, SpO2, RR or EtCO2 Sweep speed : 6.25, 12.5, 25, 50 mm/sec

Indicator	Categorized alarms (3 priority levels), Visual alarm lamp handle SpO2 pulse pitch tone, Battery status, External power LED
Interface	DC input connector : 18VDC, 2.8A Defibrillator Sync. Output : <ul style="list-style-type: none">- Signal Level : 0 to 5V pulse- Pulse width : 100 ± 10 ms LAN digital output for transferring data, Nurse call system connection DC output : 5VDC, 1A Max
Battery	Rechargeable Li-ion battery, 1hours for continuous working
Thermal Printer (option)	Speed : 25, 50mm/sec, Paper width : 58mm
Data Storage	168hours trends, 20cases of 10sec alarm waveform
Language	English, French, Spanish, Italian, Germany, Chinese, Russian, Czech, Bulgarian, Portuguese, Romanian, Hungarian, Turkish, Polish

ECG

Lead type	3-lead, 5-lead(option)
Lead Selection	3-lead : I, II, III 5-lead : I, II, III, aVR, aVL, aVF, V
ECG waveforms	3-lead : 1 channel 5-lead : 1 channel
Heart Rate Range	Adult : 30 – 300 bpm Neonate/Pediatric : 30 – 350 bpm
Heart Rate Accuracy	± 1 bpm or $\pm 1\%$, whichever is greater
Sweep speed	6.25, 12.5, 25, 50 mm/sec
Filter	Diagnostic mode : 0.05Hz - 150Hz Monitoring mode : 0.5 – 40 Hz Surgical mode : 0.5 – 25 Hz
S-T segment detection range	-2.0 to 2.0 mV
Arrhythmia analysis	ASYSTOLE,VTACH,VFIB,BIGEMINY,ACCVENT, COUPLET,IRREGULAR,PAUSE,PVC,RONT,TRIGEMINY,VBRADY, SHORTRUN
Pacemaker Detection Mode	Indicator on waveform display (user selectable)
Protection	Against electrosurgical interference and defibrillation

Respiration Performance

Method	Thoracic impedance
Channel selection	RA-LL
Measurement range	5 – 120 Breath per minute
Accuracy	± 1 Breath per minute
Apnea alarm	Yes

SpO2 Performance

Saturation range	0 to 100%
------------------	-----------

Saturation accuracy	70 to 100% ± 2 digits 0 to 69% unspecified
Pulse rate range	30 to 254 bpm
Pulse rate accuracy	± 2 bpm

NIBP Performance

Method	Oscillometry with linear deflation
Operation Mode	Manual/Automatic/Continuous
Measurement range	Adult Pressure : 20 to 260 mmHg Pediatric Pressure : 20 to 230 mmHg Neonate Pressure : 20 to 120 mmHg
Accuracy	mean error : less than ± 5 mmHg standard deviation : less than 8 mmHg

Temperature Performance

Measurement range	0 to 50°C (0 to 122°F)
Accuracy	25°C to 50°C: ± 0.1 °C 0°C to 24°C: ± 0.2 °C
Compatibility	YSI Series 400 temperature probes

Sidestream CO2 (Option)

Measurement range	0 to 150 mmHg, 0 to 19%
Accuracy	0-40mmHg ± 2 mmHg, 41-70mmHg $\pm 5\%$ of reading 71-100mmHg $\pm 8\%$ of reading, 101-150mmHg $\pm 10\%$ of reading
Respiration rate	2 to 150 breath per minute
Respiration accuracy	± 1 breath per minute

Mainstream CO2 (Option)

Measurement range	0 to 150 mmHg, 0 to 19%
Accuracy	0-40mmHg ± 2 mmHg, 41-70mmHg $\pm 5\%$ of reading 71-100mmHg $\pm 8\%$ of reading, 101-150mmHg $\pm 10\%$ of reading
Respiration rate	0 to 150 breath per minute
Respiration accuracy	± 1 breath per minute

C.O. (Option)

Method	Thermodilution Technology
Measuring Range	C.O. : 0.1 ~ 20L/min TB : 23 ~ 45°C TI : 0 ~ 27°C Alarm range 23 ~ 45°C

Product Configuration

1. Main body of BM3 Monitor	1 EA
2. 3-Lead patient Cable	1EA
3. Disposable electrodes	10 EA
4. NIBP extension horse	1EA
5. Reusable Adult NIBP Cuff	1EA
6. SpO2 extension cable	1EA
7. Reusable Adult SpO2 Probe	1 EA
8. DC Adaptor (BPM050S18F02 made in Bridgepower Co., Ltd.)	1 EA
9. Operator`s Manual	1 EA
10. Thermal roll Paper	2ROLL

Option Product

1. Reusable Temperature Probe (Surface/Skin, TEMPSENS-430)	1 EA
2. Sidestream EtCO2 Module (Respironics)	1 SET
3. Mainstream EtCO2 Module (Respironics)	1 SET
4. Sidestream EtCO2 airway adapter sampling kit	1 EA
5. Mainstream EtCO2 airway adapter	1 EA
6. Mainstream EtCO2 airway adapter	1 EA
7. 5-Lead Patient Cable with extension cable	1 EA

Adult & Pediatric-ICU Mode

Alarm level

	High	Medium	Low	Message
Asystole	0			
VTAC/VFIB	0			
VTAC	0			
PVC Count			0	
ST			0	
HR		0		
NIBP - S		0		
NIBP - M		0		
NIBP - D		0		
NIBP- PR				0
SpO ₂			0	
SpO ₂ -Rate				0
RR				0
RR-Apnea				0
T1(° C)				0
EtCO ₂			0	
FiCO ₂				0
AWRR			0	
LEAD FAULT				0
CABLE OFF				0
LOW BATTERY				0

Neonate-ICU Mode

Alarm level

	High	Medium	Low	Message
Asystole	0			
VTAC/VFIB	0			
VTAC	0			
PVC Count			0	
ST			0	
HR		0		
NIBP - S		0		
NIBP - M		0		
NIBP - D		0		
NIBP- PR				0
SpO₂			0	
SpO₂-Rate				0
RR				0
RR-Apnea				0
T1(° C)				0
EtCO₂			0	
FiCO₂				0
AWRR			0	
LEAD FAULT				0
CABLE OFF				0
LOW BATTERY				0

Parameter Limits

	Adult	Pediatric	Neonate
HR	50 – 150	50 – 160	50 – 170
NIBP-S	80 – 200	60 – 160	40 – 100
NIBP-M	40 – 140	40 – 120	30 – 70
NIBP-D	20 – 120	30 – 100	20 – 60
NIBP-PR	50 – 150	50 – 160	50 – 170
SpO₂	90 – 100	90-100	88-100
SpO₂-Rate	50 – 150	50 – 160	50 – 170
RR(RESP)	10 – 30	10 – 50	15-100
RR-Apnea	0 – 20	0 – 20	0 – 20
T1 °C / °F	34.0/93.2 - 39.0/102.2	34.0/93.2 - 39.0/102.2	34.0/93.2 - 39.0/102.2
ST	-0.4 – 0.4	-0.4 – 0.4	-0.4 – 0.4
PVC Count	0 – 20	0 – 20	0 – 15
AWRR	10 – 30	10 – 50	15 – 100
EtCO₂	25 – 50	25 – 50	25 – 50
FiCO₂	0 – 5	0 – 5	0 – 5

Display

Patient Age	Adult	PEDIATRIC	NEONATE
Primary ECG	II	II	II
Arrhythmia	LETHAL	LETHAL	LETHAL
Detect Pace	Off	Off	Off
Print Waveform1	LEAD II	LEAD II	LEAD II
Print Waveform2	SpO2	SpO2	SpO2
Print Waveform3	Resp	Resp	Resp
Alarm Print	Off	Off	Off
NIBP Interval	Off	Off	Off
NIBP Cuff Size	Adult	PEDIATRIC	NEONATE
RR(Resp) Lead	II	II	II
Alarm Volume	50%	50%	50%
QRS Volume	Off	Off	Off
Pulse Volume	Off	Off	Off
ECG Lead Fault	Message	Message	Message
SpO2 Probe Off	Message	Message	Message
Units for Height	cm	cm	cm
Units for Weight	Kg	kg	kg
Temperature Units	° C	° C	° C
NIBP Limit Type	Systolic	Systolic	Systolic
ECG Filter	Monitor	Monitor	Monitor
PVC	ON	ON	ON
ST	ON	ON	ON

Abbreviations and Symbols

Abbreviations and symbols are alphabetized by reference, which can be read while reading the manual or using the equipment.

Abbreviations

A

A	amps
AC	alternating current
ADT	adult
ARRYTHM	arrhythmia
ASYS	asystole
Auto, AUTO	automatic
AUX	Auxiliary
aVF	left foot augmented lead
aVL	left arm augmented lead
aVR	right arm augmented lead

B

BPM	beats per minute
-----	------------------

C

C	Celsius
CAL	calibration
cm, CM	centimeter

D

D	diastolic
DC	direct current
DEFIB, Defib	defibrillator
DIA	diastolic

E

ECG	electrocardiograph
EMC	electromagnetic compatibility
EMI	electromagnetic interference
ESU	electrosurgical cautery unit

F

F	Fahrenheit
---	------------

G

g	gram
---	------

H

HR	heart rate, hour
Hz	hertz

I

ICU	intensive care unit
Inc	incorporated

K

kg, KG kilogram

kPa kilopascal

L

L liter, left

LA left arm, left atrial

LBS pounds

LCD liquid crystal display

LED light emitting diode

LL left leg

M

M mean, minute

m meter

MIN, minminute

MM, mm millimeters

MM/S millimeters per second

MMHG, mmHg millimeters of mercury

mV millivolt

N

NIBP non-invasive blood pressure

NEO, Neo neonatal

O

OR operating room

P

PED pediatric

PVC premature ventricular complex

Q

QRS interval of ventricular depolarization

R

RA right arm, right atrial

RESP respiration

RL right leg

RR respiration rate

S

S systolic

sec second

SpO2 arterial oxygen saturation from pulse oximetry

SYNC, Sync synchronization

SYS systolic

T

Temp, TEMP temperature

U

V

V	precordial lead
V	volt
V-Fib, VFIB	ventricular fibrillation
VTAC	ventricular tachycardia

W

X

X	multiplier when used with a number (2X)
---	---

Symbols

&	and
°	degree(s)
>	greater than
<	less than
-	minus
#	number
%	percent
±	plus or minus

PRODUCT WARRANTY

Product Name	Patient Monitor
Model Name	BM3
Approval Number	
Approval Date	
Serial Number	
Warranty Period	1 year from date of purchase
Date of Purchase	
Customer section	Hospital Name : Address : Name : Phone :
Sales Agency	
Manufacturer	

* Thank you for purchasing BM3

* The product is manufactured and passed through strict quality control and through inspection.

* Compensation standard concerning repair, replacement, refund of the product complies with "Consumer's Protection Law" noticed by Korea Fair Trade Commission.

International Sales & Service Contact

Bionet Co., Ltd. :

#5F, 61 Digital-ro 31 gil,
Guro-gu, Seoul, REPUBLIC OF KOREA

Tel : +82-2-6300-6418 / Fax : +82-2-6300-6454 / e-mail: sales@ebionet.com

Website: www.ebionet.com

U.S.A sales & service representative

Bionet America, Inc. :

2691, Dow Ave, Suite B

Tustin, CA 92780 U.S.A.

Toll Free : 1-877-924-6638 FAX : 1-714-734-1761 / e-mail: support@bionetus.com

Website : www.bionetus.com

European sales & service representative

MGB Endoskopische Geräte GmbH Berlin :

Schwarzschildstraße 6

D-12489 Berlin, Germany

Tel. +49(0)306392-7000 / Fax. +49(0)306392-7011 / e-mail: sales@mgb-berlin.de

Website: www.mgb-berlin.de

BIONET CO., LTD.

Product Name: BM3