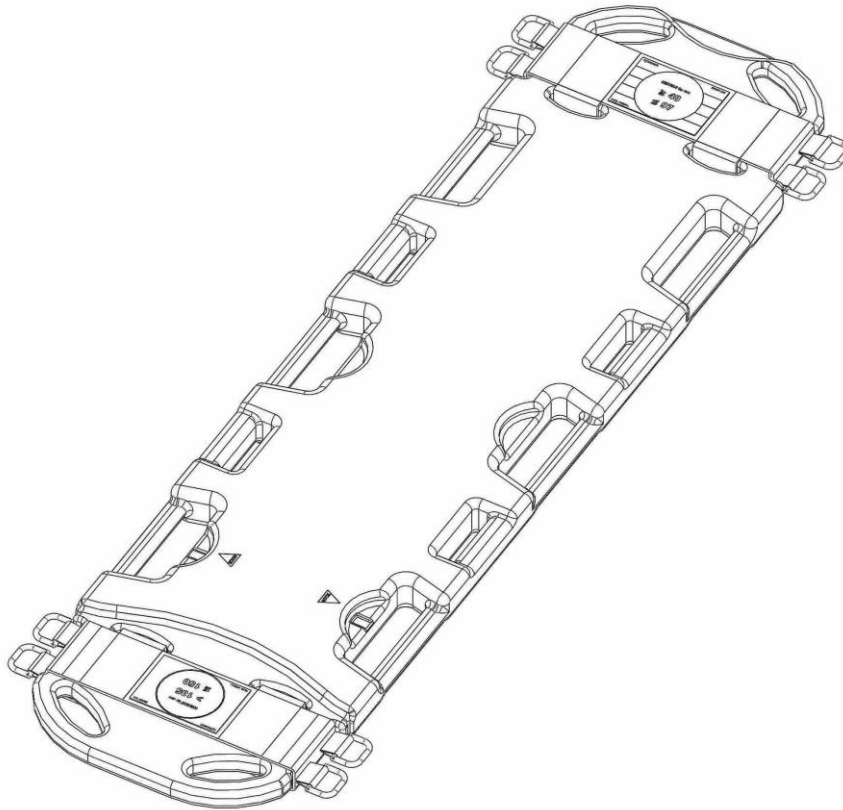

User's Manual**BABY GO**
Modular paediatric spine board

CE This appliance conforms with the Directive 93/42/CEE "Medical Devices"

Guarantee of Quality system for the production and the final control of the products certified by the notifying body TÜV SÜD Product Service GmbH

INDEX

General information	page 15	Operating instructions	page 19
Warnings	page 15	Maintenance and cleaning	page 23
Product description	page 18	Accessories and spare parts	page 24

First edition: 27/03/09
Rev. 2: 21/09/15

1. GENERAL INFORMATION





1.1 Aim and contents

The aim of this manual is to supply all the information necessary so that the client, will not only attain adequate use of the appliance, he will also be capable of using the instrument in the most autonomous and secure way possible. This includes information regarding technical aspects, functioning, maintenance, spare parts and safety.

1.2 Conservation of the instruction and maintenance manual

The instruction and maintenance manual must be kept together with the product, for the whole life of the device, inside a dedicated container and above all, away from any substances or liquids which could compromise perfect legibility.

1.3 Symbols used

Symbol	Meaning
	General or specific warnings
	See instructions for use
	Lot number
	Product code
	The product is compliant with the specifications of the Directive 93/42/CEE

1.4 Servicing request

For any information regarding the correct interpretation of the instruction manual, the use, maintenance, installation and restore of the product, please contact the Spencer Customer Care Service tel. 0039 0521 541111, fax 0039 0521 541222, e-mail service@spencer.it or write to Spencer Italia S.r.l. - Strada Cavi, 7 - 43044 Collecchio (Parma) - ITALY. In order to facilitate the assistance service, please always indicate the lot number (LOT) shown on the label applied on the box or on the device.

1.5 Demolition

When the devices are no more suitable for being used, if they haven't been contaminated by any particular agents, they can be disposed of as normal solid waste, otherwise follow the current regulations about demolition in each country.

1.6 Labelling

Each device has got an identifying label, positioned on the device itself and/or on the box. This label includes information about the manufacturer, the product, the CE mark, the lot number (LOT). It must never be removed or covered.

2. WARNINGS

2.1 General warnings

- The product must be used by trained personnel only, having attended specific training for this device and not for similar products.
- Training routines must be registered on a special register in which the names of those trained, of the trainers, date and place are indicated. This register which will certify the eligibility of the operators to use the Spencer device has to be kept for a period of 10 years after the disposal of the device itself. This register will be made available to the competent authorities and/or manufacturer if requested.
- Spencer Italia S.r.l. is always at your disposal to plan trainings on products.
- Before carrying out any kind of operation on the appliance (training, installation, use), the operator must carefully read the enclosed instructions, paying particular attention to the correct safety precautions and to the procedures to be followed for installation and for correct use.
- If the instructions belong to another device and not to the device received, inform the manufacturer immediately and avoid use of the device.
- In case of any doubts about the correct interpretation of the instructions, please contact Spencer Italia S.r.l. for any necessary clarifications.

- Do not allow untrained persons to help during the use of the device, because they could cause damage to the patient or to themselves.
- Regularly check the appliance, carry out the prescribed maintenance and respect the average life span, as indicated by the manufacturer in this user's manual.
- Before each use of device the perfect operating state of the device must be checked as specified in the instruction manual. If any damage or abnormalities which could in any way influence the correct functioning and the safety of the device, of the patient and of the user are detected, the device must be immediately removed from service and the manufacturer must be contacted.
- If any failure or incorrect functioning of the device is detected, it must be immediately substituted with a similar item so that the rescue procedures are guaranteed without any interruption.
- Use of the device in anyway other than described in this manual is forbidden.
- Do not alter or modify in any way the appliance; any such interference could cause malfunctions and injury to the patient and/or rescuer.
- The appliance must not in any way be tampered with (modification, adjustment, addition, replacement). In such cases all responsibility will be denied for any malfunctions or injuries caused by the appliance itself; moreover CE certification and product warranty will be considered void.
- Those who modify or have modified, prepare or have prepared medical appliances in such a way that they no longer serve the purpose for which they were intended, or no longer supply the intended service, must satisfy the valid conditions for the introduction onto the market.
- Handle with care.
- Ensure that all the necessary precautions are taken in order to avoid the hazards that can arise as the result of contact with blood or body fluids.
- Register and store with these instructions: lot number, place and date of purchase, first date of use, date of checks, name of users, any comments.
- When the device is being used, the assistance of qualified staff must be guaranteed.
- Do not store the device underneath any heavy objects which could cause structural damage.
- Store in a cool, dry, dark place and do not expose to direct sun.
- Store and transport device in its original packaging.
- The device not be exposed to or come into contact with any source of combustion or inflammable agents.
- Position and adjust the device taking care not to cause any obstruction to rescuers and or any other rescue equipment.
- Attention: laboratory testing, post production tests, instruction manuals cannot always consider every possible scenario for use. This means that in some cases the performance of the product could be notable different from results to date obtained. Instructions are continually being updated and are under tight surveillance of fully qualified staffs with adequate technical formation.
- With reference to the D. Lgs. 24th February 1997, n. 46 emended by D. Lgs. 25/01/2010, n. 37 – Acknowledgement of Directive 93/42/CEE and 2007/47/CE, we remind both public and private operators that they are obliged to report any accident that involves any medical device to the Ministry of Health and to the Manufacture as specified and within time given by the European regulations.
- In addition, both public and private operators are obliged to inform the manufacturer of any measures that should be adopted to make the steps necessary to guarantee the safety and the health of the patients and the users o any medical device.
- As a distributor or end user of products manufactured and/or marketed by Spencer Italia S.r.l., you are strictly required to have a basic knowledge of any legal requirements applying to the devices contained in this supply that are in power in the goods final destination Country (including laws and norms regarding technical specifications and/or safety requirements) and therefore you are also strictly required to have the necessary knowledge to guarantee all aspects regarding the total conformity of the products to the regulations in the relevant territory.
- Promptly notify Spencer Italia S.r.l. regarding any revisions to be made by manufacturer in order to guarantee the conformity of the product to the territory's legal specifications (including those resulting from rules and/or norms of other nature).
- Act, with all due care and diligence, and contribute to ensure conformity to general safety requirements of all devices marketed in the territory, by providing final users with all necessary information for carrying out periodical checks on their devices, as specified in the relevant user's manual.
- Actively contribute to product safety checks on products sold, by communicating any relevant risk analysis information both to the manufacturer and to any competent authorities so that the necessary action can be promptly taken.

- The distributor or final user is aware that in the event of any failure to conform to the above mentioned requirements you will be deemed fully responsible for all damages that might occur. Therefore Spencer Italia S.r.l. expressly disclaims any responsibility and/or liability for your non-compliance with the present regulatory provisions.



2.2 Specific warnings

- Establish a maintenance program and periodic testing, identifying a reference employee. The person to whom the ordinary maintenance of the device is entrusted must ensure the basic requirements foreseen by the manufacturer in the user's manual.
- All maintenance and periodic check activities must be registered and collected together with their intervention reports (see Maintenance Register) these documents have to be kept for a period of 10 years after the disposal of the device itself. This register will be made available to the competent authorities and/or manufacturer if requested.
- Use only components/spare parts and/or accessories that are original or approved by Spencer Italia S.r.l. in order to carry out any operation without causing any alteration or modification to the device, otherwise we assume no responsibility for the proper functioning or damage resulting from device to the patient or the operator and warranty and will be considered void according to the compliance to the Medical Device Directive 93/42/CEE.
- Always respect the maximum load capacity of the device, as indicated in this user's manual. Maximum load capacity means the total weight distributed according to the human anatomy. In determining the load of the total weight on the product, the operator must consider the weight of the patient, the equipment and the accessories. Moreover, the operator must consider that the overall dimensions of the patient do not reduce the functionality of the device.
- Never leave the patient unassisted on the device, because he may be injured.
- The device and all its components, after washing, should be allowed to dry completely before storing.
- Follow the procedures approved by the Emergency Medical Services for the immobilization of the patient.
- Follow the procedures approved by the Emergency Medical Services for the positioning and transport of the patient.
- Do not wash the device in the washing machine.
- Do not use drying machines.
- Avoid contact with sharp objects.
- Do not use the device if it is pierced, torn, frayed or excessively worn out.
- Make sure, before lifting, that the operators have a firm grip on the device.
- Avoid pulling the device on rough surfaces.
- Do not lift by crane or other mechanical lifts.
- The device is a spine board for patients transport and cannot be used as a stationing device
- First practice with an empty spine board in order to get used to the way in which the spine board manoeuvres.
- For the use of the device, at least two operators in suitable physical conditions are needed; they must therefore have strength, balance, coordination, and common sense and must be trained on the correct functioning of the Spencer device.
- For techniques for loading particularly heavy patients, for rescue operations on steep ground or in unusual circumstances, it is recommended the presence of more operators (not just as required under standard conditions).
- The maximum weight sustained by each rescuer must comply with requirements prescribed by the law of the Country, concerning Health and Safety at Work.
- Always immobilize the patient, using the straps supplied by the manufacturer; lack of immobilization may cause serious damage.
- Do not operate in case the weight has not been distributed correctly.
- Use the backboard only as described in this Manual
- Do not alter or modify the spine board arbitrarily, the modification may cause unforeseeable functioning and damages to the patient and operators. In any case the warranty will be lost. The manufacturer will no more considered responsible.
- Pay a lot of attention to possible obstacles (water, ice, debris, etc.) on the route of the chair, because they could cause loss of balance for the operator and compromise the proper functioning of the device. If you can not set the path free from obstacles, choose an alternative path.
- Condensation, water, ice and accumulations of dust can affect the correct operation of the device, making it unpredictable and causing a sudden alteration of the weight that operators have to carry.
- Should it be necessary to secure the device within the ambulance, we recommend the use of the dedicated fastening system by Spencer. The use of fasteners not approved by the manufacturer is forbidden, as they may alter the structural and functional characteristics of the spine board.

- Paediatric spine board Baby Go cannot be used for paediatric patients taller than 115 cm.
- The compensation system of the nuchal space for the paediatric spine board is also identified for heights greater than the maximum allowable on the spine board, this only to give feedback in clinical terms for the entire range possible.

2.3 Contraindications and side effects

The use of this device, if used as described in this manual, does not present any contraindications or collateral effects.

2.4 Physical requirements of the operators

The paediatric Baby Go is a device destined to professional use only. The rescue operators must have the following minimum requirements:

- physical capacity for operating the device
- be able to seize the device firmly with both hands
- have strong back, arms and legs for lifting, pushing and pulling the device
- have a good muscular coordination

Every operator must be trained in efficient and safe patient transport.



Patient loading procedures for extremely heavy patients, operations in rough terrain and in particular situations more operators may be needed (not only as in normal conditions).



The capacities of the operators must be considered before determining their roles in the employment of the device.

3. DESCRIPTION OF PRODUCT

3.1 Intended use

The paediatric spine board Baby Go is a device for the immobilization of paediatric patient with suspected traumatic injury. Basic equipment for emergency trauma care, it optimizes the positioning of the patient and allows maintaining the spine in the neutral position, achieving a perfect alignment of the airways. The device is based on the concept of absolute versatility, with an innovative alignment of the spine of the paediatric patient based on different body types.

3.2 Main components

The device consists of the following main components:

- polyethylene shell
- bands for fastening the head immobilizer paediatric

3.3 Models

These basic models could be modified, with reference to codes and/or descriptions without any previous notification.

ST02141B Baby Go – Modular paediatric spine board

3.4 Technical data

Characteristics	Baby Go
Length (mm)	1190
Width (mm)	320
Thickness (mm)	45
Handles	10
Fixing pins	/
Load capacity (kg)	30
Weight (kg)	3
Material	Polyethylene

3.5 Reference standards

Reference	Title of document
MDD 93/42/CEE	European Directive about Medical Devices
MDD 2007/47/CEE	Modifications to 90/385/CEE Directive about active implants, Directive 93/42/CEE about medical devices and Directive 98/8/CE about the introduction of biocides onto the market
Legislative Decree 24/02/1997, n. 46	Application of the 93/42/CEE Directive about Medical Devices
Legislative Decree 25/01/2010, n. 35	Modifications and additions to the 20/02/97 Decree n. 46
UNI EN ISO 14971	Application of risks managing to medical devices
UNI CEI EN 980	Graphic symbols used for medical devices labelling
UNI CEI EN 1041	Information supplied by the medical devices manufacturer
CEI EN 62366	Medical Devices - Application of the utilisation characteristics of engineering to medical devices
MEDDEV 2.4/1a-b	Guideline for the classification of medical devices
NB-MED 2.5.1/Rec 5	Technical Documentation
MEDDEV 2.7.1	Clinical Data
UNI EN 14155	Clinical evaluation of the medical devices for human beings - Part 2: Clinical evaluation plans

3.6 Environmental conditions

Functioning temperature: from -10 to +50 °C

Storage temperature: from -20 to +60 °C

Relative humidity: from 0 to 100 %

4. OPERATING INSTRUCTIONS

4.1 Transport and storage

Before transporting the appliance, make sure that it is correctly packaged ensuring also that there are no risks of shocks, bumps or falls during the transport itself.

Keep the original packaging for use in case of any further transport and for storage. Damage to the appliance caused during transport and handling is not covered by the guarantee. Repairs or replacement of the damaged parts are the responsibility of the client. The device must be stored in a dry, cool area away from direct sunlight. It must not be placed in contact with any substances or chemical agents which could cause damage and reduce safety characteristics.

4.2 Preparation

On receipt of the product:

- Remove the packaging and display the material so that all components are visible.
- Check that all the components/pieces on the accompanying list are present.

The appliance must be checked before every use so as to reveal any working abnormalities and/or damage caused by transport and/or storage. In particular, check:

- General functionality of the device
- Cleanliness of the device (remember that the failure of cleaning may cause the risk of cross infections)
- Absence of cuts, holes, tears on the structure, including the straps
- State of use
- Integrity of handles (are torn or signs of laceration?)
- The emergency vehicle is equipped with a fastening system dedicated to the Spencer spine board
- There are belts for the immobilization of the patient and they are intact and functioning

If the above conditions are met, the device may be considered ready for use; otherwise you must immediately remove the device from service and contact the manufacturer.

4.3 Functioning



Follow the procedures approved by the reference Emergency Medical Service for immobilization, positioning and patient transport.

The following procedures are shown on the basis of general information use.



For the fixation on the paediatric spine board, identify before use the correct part to place the patient, using the yardstick of the belts of paediatric immobilization system Spencer RSP (code ST02018A).

4.3.1 Loading the prone patient on the spine board

This manoeuvre should be performed by at least three rescuers (Res.).

- Res. 1 sends Res. 2 to immobilize the spine, at the same time he tells the patient not to move and communicate the manoeuvres to be carried out.
- Res. 2 takes kneeling position behind the patient's head in misaligned position, so that at the end of the pronation-supination he will be aligned as much as possible to the patient's head.
- Res. 2 manually immobilizes the cervical spine with his hands in such a position that they do not become crossed during rotation; he slips his hand under the patient's head to get a good grip, making sure to move the head as little as possible (fig. A).
- Res. 1 and 3 align the limbs along the axis of the body, lifting them the bare minimum. The movement of alignment is carried out in two phases:
 - Alignment of the limb
 - Approach of the body
- Res. 3 places the spine board at the patient's side (the opposite side of the sight), lying on the ground, and makes sure that the head is at the centre of the pillow.
- Res. 1 and 3 take kneeling position at the side of the patient from the side of rotation, with a knee above the spine board, and are positioned one on the trunk and one to the pelvis. Res. 1 places his hands at shoulder and pelvis, including the patient's wrist. Res. 3 places his hands at the side and the femur (fig. B).
- Res. 2 at the head controls the rotation of the patient on the side, saying: "On three. One, two, three."
- At "three" Res. 1 and 3 rotate the patient 90 degrees, keeping the entire column immobilized in line, they stop at the "stop" of Res. 2 (fig. C).
- Res. 1 and 3, keeping the patient on the side, move their hands. Res. 1 rotates both hands, Res. 3 rotates the one on the femur, while he moves to the back the hand that was previously on the side. This allows to support the patient during descent in the supine position (fig. D).
- When Res. 1 and 3 are ready, they shall notify Res. 2, which gives instructions to rotate the patient an additional 90 degrees up to the supine position. At the same time they draw back up to get off the spine board with their knees.
- Once on the ground Res. 2, placed at the head, keeps the immobilization of the cervical spine.
- If necessary Res. 2 communicates to others that the patient should be centred on the spine board. Res. 1 and 3 are put astride the patient and position respectively hands under her armpits and on the iliac crests. At the start of Res. 2 at the head, they place the patient at the centre of the spine board translating him without lifting and maintaining the alignment of the column.
- Once the patient is aligned, place a shim under the head if necessary to maintain the neutral position.
- Secure the patient to the spine board after he has been centred on the device.

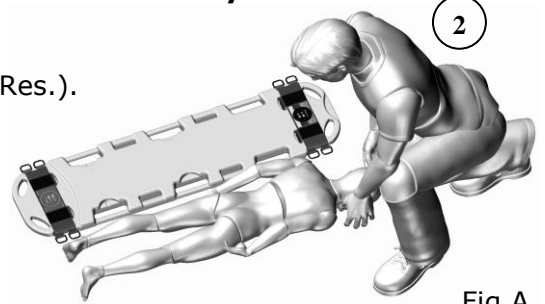

Fig.A

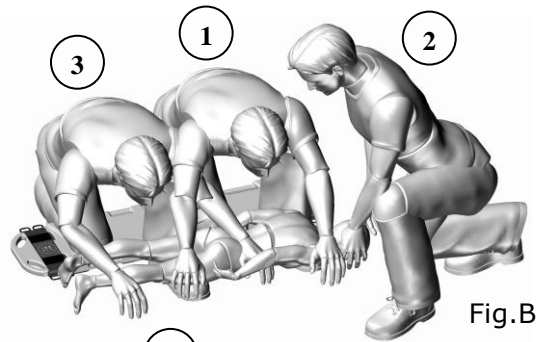

Fig.B

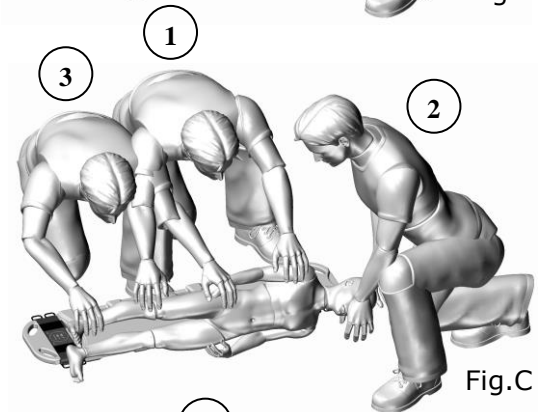

Fig.C

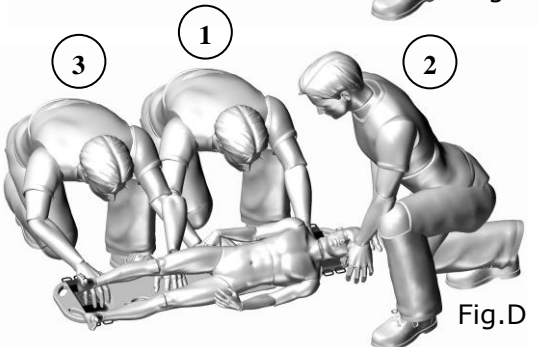

Fig.D

4.3.2 Loading the supine patient on the spine board

This manoeuvre should be performed by at least three rescuers (Res.).

- Res. 1 sends Res. 2 to immobilize the spine, at the same time he tells the patient not to move and communicate the manoeuvres to be carried out.
- Res. 1 and 3 align the limbs along the axis of the body, lifting them the bare minimum. The movement of alignment is carried out in two phases:
 - Alignment of the limb
 - Approach of the body
- Res. 3 places the spine board at the patient's side, lying on the ground, and makes sure that the head is (in height) at the centre of the pillow.
- Res. 1 and 3 take kneeling position at the side of the patient from the side of rotation, with a knee above the spine board, and are positioned one on the trunk and one to the pelvis. Res. 1 places his hands at shoulder and pelvis, including the patient's wrist. Res. 3 places his hands at the side and the femur (fig. F).
- Res. 2 at the head controls the rotation of the patient on the side, saying: "On three. One, two, three."
- At "three" Res. 1 and 3 rotate the patient 90 degrees, keeping the entire column immobilized in line, they stop at the "stop" of Res. 2 (fig. G).
- While Res. 1 maintains the patient still on the side, Res. 3 puts his hand, that first held the femur, on the spine board to move it towards the patient and keeping it aligned and in contact with him. At this point he raises it on the opposite side of about 45 degrees and Res. 1 with the hand that held the basin before, helps Res. 3 to support the spine board (fig. H).
- When Res. 1 and 3 are ready, they shall notify Res. 2, which gives instructions to rotate the patient an additional 45 degrees to make him lay on the spine board (fig. I).
- When the patient is leaning against the spine board, Res. 1 and 3 move their hands, which previously held the patient, on the side of rotation thereof to support him and keep him in position on the stretcher during the completion of the rotation (fig. L).
- If the patient will not be centred on the spine board, to centre him the rescuers will use a "bridge" manoeuvre:
 - Res. 2 at the head of the patient
 - Res. 1 is positioned in the chest with his hands under the armpits of the patient
 - Res. 3 places his hands at the iliac crests
 - Res. 1, 2 and 3, maintaining the alignment and at the start of Res. 2, centre the patient by sliding him to the side
- Once the patient is aligned, place a shim under the head if necessary to maintain the neutral position.
- Secure the patient to the spine board after he has been centred on the device.

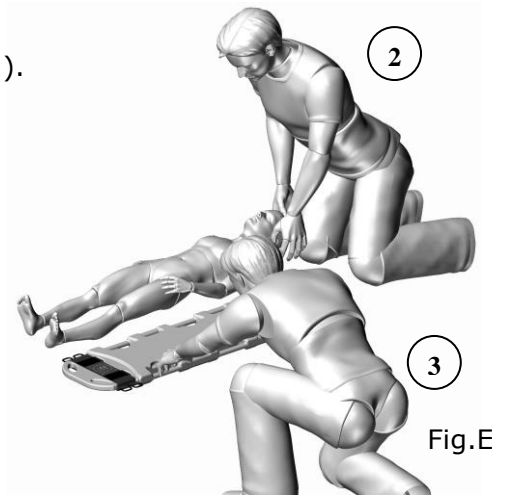

Fig.E

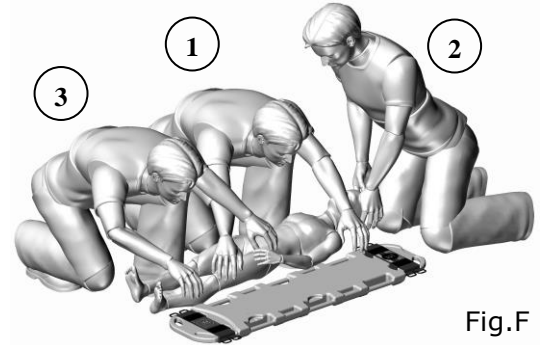

Fig.F

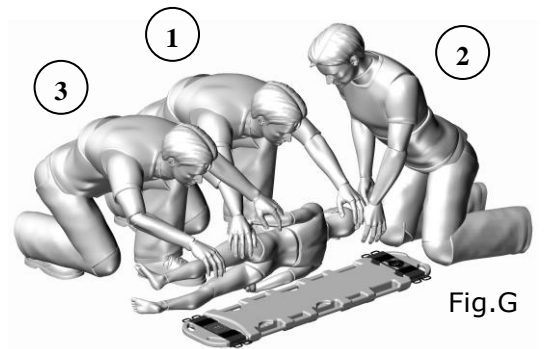

Fig.G

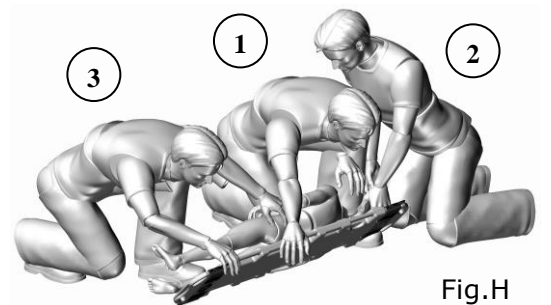

Fig.H

⚠ If you suspect a lesion of the column, to place the supine patient on the spine board, use a scoop stretcher.

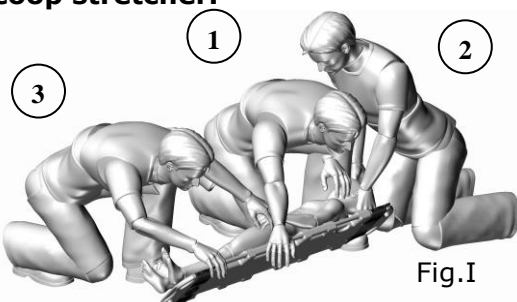

Fig.I

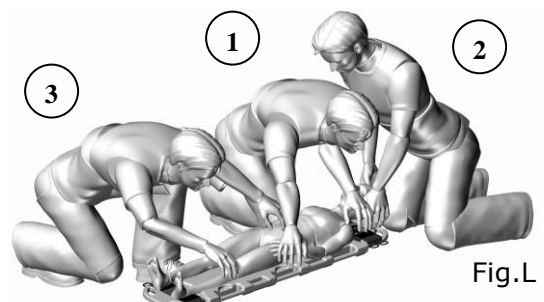

Fig.L

4.3.3 Loading the standing patient on the spine board

- This operation should be performed by at least four rescuers (one can be a bystander).
- Res. 2 stands behind the patient and applies the manual fixed-line immobilization from behind.
- Res. 1 positions the cervical collar.

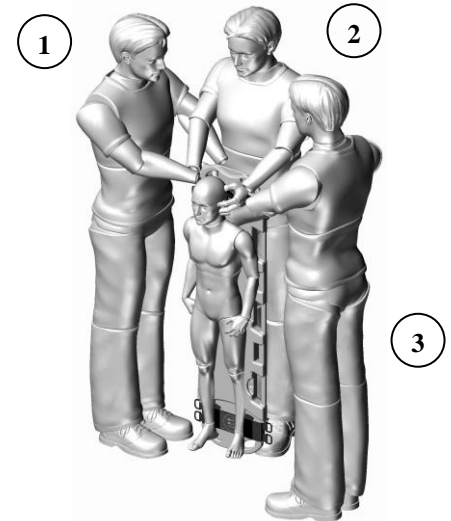

Fig.M

- Res. 1 and 3 insert the spine board behind the patient, inserting it sideways into the arms of Res. 2. Res. 3 maintains the asset in line hold down the boards against the patient with the pelvis and legs (fig.M).

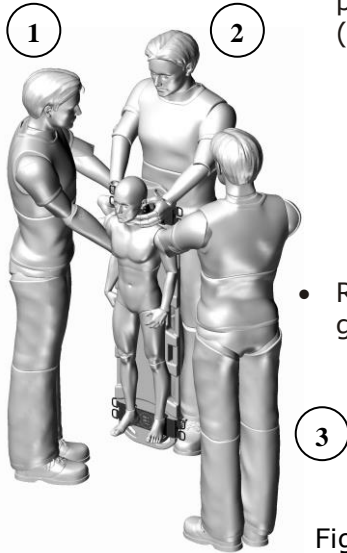

Fig.N

- Res. 1 and 3, one on each side, insert the arm in the armpit of the patient grasping the handle of the spine board just above the armpit (fig.N);

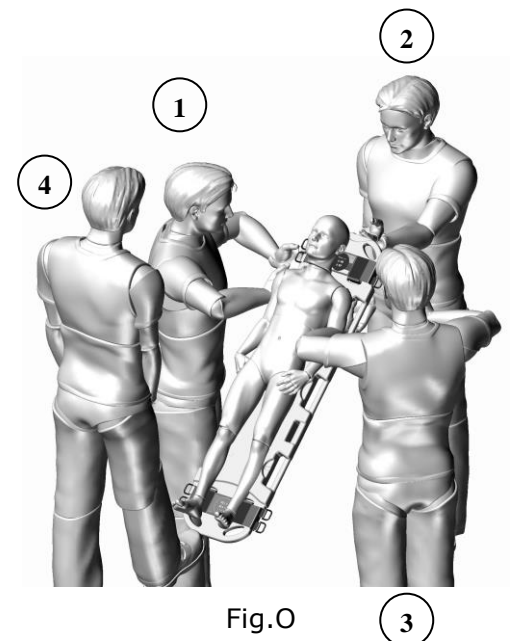

Fig.O

- Res. 4 or a bystander puts a foot on the end of the table so that it can not slip.
- Res. 1 and 3 are challenging the spine board with the other free hand and the lower to the ground, stopping approximately half way to allow the Res. 2 officer heads to reposition the hands without leaving immobilization. Even the Res. 1 and 3 on the sides can relocate your hands (fig.O).
- Once the spine board is lowered to the ground, the Res. 2 head kneels down and keeps the spine immobilized.
- Once the patient is aligned, place a shim under the head if necessary to maintain the neutral position.
- Secure the patient to the spine board after he has been centred on the device.

4.3.4 Immobilization of the patient on the spine board



This operation must be carried out as the final stage of the procedures outlined above. Pay particular attention during immobilization as, if not correctly performed, it could jeopardize the success of the rescue.

- Place the head immobilizer (Pedi Roll or Pedi Go) in such a way as to ensure the best alignment of the cervical spine. For the use of the head immobilizer on the paediatric spine board verify that the inspection area is correct (when used the paediatric head immobilizer), in case the patient is not in the right position, translate it towards the upper edge side head.
- Place the chin/head straps with quick release couplings if they are present, or in the slots in the case of simple straps. For immobilization of the paediatric patient use the appropriate straps of the correct measure present in their dedicated immobilizer.
- Immobilization of the patient on the spine board, using the belts (Spencer RSP code ST02018A) to ensure stability and solidarity of the patient to the device. Pass the belts in the slots of the spine board, so that the slots in charge to be used as handles are free.

4.4 Troubleshooting

PROBLEM	CAUSE	REMEDY
The spinal board not sustains the weight of the patient and tends to bend	Internal rods damaged or broken	Put immediately the stretcher out of service and contact the service centre.

5. MAINTENANCE AND CLEANING

5.1 Cleaning



Failure to carry out the correct cleaning routine could increase the risk of cross infection, due to presence of body fluids and/or residuals.

The operator must always wear adequate personal protection such as gloves and mask etc. during all checking and cleaning procedures.

Clean the exposed parts with water and delicate soap then dry with a soft cloth.

In the event of a possible disinfection use products that have not solvent or corrosive action on the materials constituting the device.

Rinse thoroughly with warm water making sure that you have removed all traces of detergent, which could degrade or compromise the integrity and durability of the device.

The use of high pressure water should be avoided.

Allow to dry thoroughly before storing. Drying after washing or after use in wet environments must be natural and not forced, do not use flames or other sources of direct heat.

In the presence of blood, let it oxydate before proceeding to washing with water.

5.2 Maintenance



Establish a maintenance program and periodic testing, identifying an reference employee. The person who carries out the maintenance of the appliance has to guarantee the basic requirements indicated by the Manufacturer in the following paragraphs.

All maintenance activities, both precautionary and special, must be registered on documents including technical reports about operations. This register has to be kept for a period of at least 10 years after the disposal of the device itself. This register will be made available to the Competent Authorities and/or Manufacturer if requested.

With reference to the D. Lgs. 24th February 1997, n. 46 emended by D. Lgs. 25/01/2010, n. 37 – Acknowledgement of Directive 93/42/CEE and 2007/47/CE, we remind both public and private operators that they are obliged to report any accident that involves any medical device to the Ministry of Health and to the Manufacture as specified and within time given by the European regulations. In addition, both public and private operators are obliged to inform the Manufacturer of any measures that should be adopted to make the steps necessary to guarantee the safety and the health of the patients and the users o any medical device.

5.2.1 Precautionary maintenance

The person who carries out the precautionary maintenance of the appliance has to guarantee the following basic requirements:

- Technical knowledge of the appliance and of the periodic maintenance procedures as described in these instructions.
- Specific qualifications and training in the maintenance operations of the appliance in question.
- The use of components/replacement parts/accessories that are either original or approved by the supplier, in such a way that each operation causes no alteration or modification to the appliance.
- Possession of the checklist of operations carried out on the appliance.
- Guarantee complete adherence to the instructions of the Directive 93/42/CEE which includes also the obligation towards the Manufacturer to maintain post sales records and traceability of the appliance if requested.



During all checking, maintenance and cleaning procedures, the operator must wear adequate personal protection such as gloves, mask, glasses etc.

Checks to be carried out before and after each use, are as follows:

- General functionality of the device
- Cleanliness of the device (remember that the failure of cleaning may cause the risk of cross infections)
- Absence of cuts, holes, tears on the structure
- State of use
- Integrity of handles (are torn or signs of laceration?)

The inspection frequency is determined by factors such as legal requirements, the type of use, frequency of use, environmental conditions during use and storage. Please note that you must do the cleaning as described in paragraph 5.1 and verify functionality before and after each use. Spencer Italia S.r.l. declines any responsibility for the proper functioning or damages caused to the patient or user by the use of devices not subject to routine maintenance warranty and will void the compliance to the Medical Device Directive 93/42/CEE.

The person responsible for routine maintenance can replace only the parts listed in paragraph 6.2 "Spare parts". The replacement or restoration of them can only be done by the manufacturer or by an authorized service centre.



Use only accessories/original spare parts approved by Spencer Italia S.r.l., otherwise we will accept no responsibility for the incorrect functioning and/or damage caused by the use of any device which has not been repaired, or certified on expiry date by the Manufacturer or by one of the Manufacturer's Authorised Service centres. Warranty will be considered void in compliance with the Medical Device Directive 93/42/EEC.

5.2.2 Periodic maintenance

There is no regular review.

5.2.3 Special servicing

Only the Manufacturer or centres with written authorisation are authorised to complete any special servicing operations.

For any operations that are not carried out directly by the Manufacturer but by an authorised centre, we have to underline that a report regarding all operations carried out must be requested. This will permit both Spencer Italia S.r.l. and the end user to keep a log book regarding the operations carried out on the device. The device, if used as indicated in the following instruction manual, has an average life span of 5 years.

Spencer Italia S.r.l. will accept no responsibility for the incorrect functioning and/or damage caused by the use of any device which has not been repaired by the Manufacturer or by one of the Manufacturer's Authorised Service centres, making void the guarantee and the conformity to the Medical Devices Directive 93/42/CEE

6. ACCESSORIES AND SPARE PARTS

6.1 Accessories

ST02018A RSP – Paediatric universal system for spine board
SH00262A Pedi Go - Paediatric head immobilizer
SH00260A Pedi Fix - Paediatric head immobilizer
ST02144B Wall bracket for Baby Go

6.2 Spare parts

ST02143B Set two bands Baby Go

ATTACHMENT A – TRAINING REGISTER



The product must be used by trained personnel only, having attended specific training for this device and not for similar products.



Keep this document at least 10 years from the end of life of the device.

Operator's name	Training date		Training method (user's manual, during service, former class, etc.)	Trainer
	Basic training	Advanced training		

ATTACHMENT B – MAINTENANCE REGISTER

 Keep this document at least 10 years from the end of life of the device.

 Perform the required maintenance and to respect the life span of the device, as indicated by the Manufacturer in the User’s Manual.

Code and description of device	
Purchase date	
Lot (LOT) or serial number (SN)	
Bought by	

SERVICE DATE	KIND OF SERVICE (Maintenance/ check/ extension of life span)	OPERATIONS MADE ON THE DEVICE	RESULT	PERSON IN CHARGE OF SERVICE (Operator/ Authorized center / Manufacturer)



Warning

The information contained in this document could be modified without any warning and is not to be intended as a commitment on behalf of Spencer Italia S.r.l. Spencer products are exported to many countries and the same identical regulations are not always valid. For this reason there could be differences between the description here described and the product actually delivered. Spencer continually strives to reach the perfection of all items sold. We therefore hope you will understand if we reserve the right, at any time, to modify the shape, equipment, lay-out or technical aspects that are herein described.

© Copyright Spencer Italia S.r.l.

All rights reserved.

No part of this document can be photocopied, reproduced or translated into another language without the written approval of Spencer Italia S.r.l.