



# GIMA

PROFESSIONAL MEDICAL PRODUCTS

## MULTI-PARAMETER PATIENT MONITOR

### User Manual

**REF 35134**



Gima S.p.A.  
Via Marconi, 1 - 20060 Gessate (MI) Italy  
gima@gimaitaly.com - export@gimaitaly.com  
[www.gimaitaly.com](http://www.gimaitaly.com)  
Made in China



# Preface

## Manual Purpose

The instructions for safe operation of product in keeping with its function and intended use are contained in this manual. In order to operate product properly, and to protect both the patient and operator from injury, compliance with this manual is first priority.

Based on the maximum configuration, some contents of this manual may not apply to your product. Please keep in touch with the manufacturer or your local sales if you have any question.

As an indispensable portion of the product, this manual should always be placed near the equipment so that it can be got easily when needed.

Only clinical professionals, anyone who are under their guidance of people who have been trained adequately can use this monitor. The unauthorized or the untrained are forbidden to operate the product.

## Intended Audience

This Manual applies to clinical professionals with knowledge medical procedures, practices and terminology required for monitoring of critically ill patients.

## Illustrations

Setup or data displayed on your monitor may not be necessarily shown in all illustrations within this Manual, illustration are used only as examples.

All names mentioned in this Manual and illustrations are fictitious. Any similarity is purely coincidental.

**Terms used in this User Manual:**

"View": Main screen when there is no any pop-up window.

"Long press": The operation pressing shortcut key for over 3 seconds.

"SpO<sub>2</sub>": Oxygen saturation.

**Notes:**

This patient monitor can be customized with different functional modules, therefore, the monitor you purchased may not cover all operations described.

**Caution:**

**Federal law restricts this device to sale by or on the order of a physician.**

# Table of Contents

Chapter 1	Safety	1
1.1	Safety Information	1
1.1.1	Warnings	1
1.1.2	Cautions	2
1.1.3	Notes	2
1.2	Equipment Symbols	4
1.2.1	Symbol/Icon on the Device	4
1.2.2	Icons List on the Screen	5
Chapter 2	The Basics	7
2.1	Monitor Description	7
2.1.1	Product Name and Model	7
2.1.2	Intended Use	7
2.1.3	Features	7
2.2	Main Unit	9
2.3	Display Screen	13
2.3.1	Information Area	14
2.3.2	Parameter Area and Waveform Area	14
Chapter 3	Operations	16
3.1	Installation	16
3.1.1	Unpacking and Checking	16
3.1.2	Environmental Requirements	16
3.2	Getting Started	17
3.2.1	Connecting to Power Source	17
3.2.2	Turning the Monitor On	18
3.2.3	Starting Monitoring	18
3.3	Turning the Monitor Off	19
3.4	Using Keys	19
3.4.1	Shortcut Key	19
3.5	Using the Main Menu	19
3.5.1	How to Select the Menu Item	19

3.6 Data Uploading.....	20
Chapter 4 Screen Display.....	21
4.1 SpO2 Trend Data List Screen.....	21
4.1.1 Screen Description.....	21
4.1.2 Operating Instructions.....	21
4.2 NIBP Data List Screen .....	21
4.2.1 Screen Description.....	21
4.2.2 Operating Instructions.....	22
4.3 Screen Display for Graphic Trend .....	22
4.3.1 How to View the Graphic Trend .....	22
4.3.2 Operation Instructions.....	24
4.4 Screen Display for Waveform Recall.....	24
4.4.1 Operation Instructions.....	25
4.5 Screen Display for Arrhythmia Event List .....	27
4.5.1 Operation Instructions.....	27
4.6 Screen Display for System Setting .....	28
4.6.1 How to Select the System Setup Item .....	28
4.7 Display Color Settings.....	28
4.7.1 How to Change the Parameter Color.....	29
4.8 File Management Screen.....	29
4.8.1 How to Add a New Patient .....	29
4.9 OxyCRG Screen .....	30
4.9.1 Operation Instructions.....	30
4.10 Event List Screen.....	31
4.10.1 Screen Description.....	31
4.10.2 Operating Instructions.....	31
4.11 MC Calculator .....	31
4.11.1 Medicine Dosage Calculator .....	31
4.12 Tourniquet Function .....	34
4.12.1 Operation Instructions .....	34
Chapter 5 Parameter Settings .....	35

5.1 System Parameter Settings.....	35
5.2 Network Related Settings.....	36
5.3 ECG Related Settings .....	37
5.4 Temperature Related Settings .....	38
5.5 NIBP Related Settings .....	39
5.6 SpO <sub>2</sub> Related Settings .....	40
5.7 Respiration Related Settings.....	40
Chapter 6 Alarms.....	42
6.1 Alarm Categories .....	42
6.2 Alarm Levels .....	42
6.3 Alarm Indicators .....	43
6.3.1 Alarm lamp .....	44
6.3.2 Alarm message .....	44
6.3.3 Highlighting Numeric.....	44
6.3.4 Audible Alarm Tones.....	44
6.3.5 Alarm Status Symbols:.....	44
6.3.6 Changing Alarm Volume .....	45
6.4 Understanding the Alarm Setting.....	45
6.4.1 High and Low Alarm Setting Range .....	45
6.4.2 Factory Default Alarm Limit Setting Value.....	47
6.5 Testing Alarms .....	47
6.6 When an Alarm Occurs.....	47
Chapter 7 ECG Monitoring .....	49
7.1 Introduction.....	49
7.2 Safety Information.....	49
7.3 Preparing to Monitor ECG .....	50
7.3.1 Preparing the Patient and Device .....	50
7.3.2 ECG Electrodes Placement.....	51
7.4 Understanding the ECG Display.....	52
7.5 Changing ECG Settings.....	53
7.6 About Arrhythmia Detection and Template Learning .....	53

7.6.1 Understand the ARR Type.....	54
7.7 About S-T Segment Monitoring.....	55
7.8 Freezing Waveform.....	56
7.9 Factors Affecting ECG signal .....	56
Chapter 8 Monitoring Respiration (RESP) .....	57
8.1 Introduction.....	57
8.2 Safety Information.....	57
8.3 Understanding the RESP Display .....	57
8.4 Changing RESP Settings .....	58
Chapter 9 Monitoring NIBP .....	59
9.1 Introduction.....	59
9.1.1 The Oscillometric Blood Pressure Measurement .....	59
9.1.2 The Oscilometric method vs. the Korotkoff Sound Method.....	59
9.2 Safety Information.....	59
9.3 Measurement Limitations .....	60
9.4 Measurement Mode.....	60
9.5 Setting Up the NIBP Measurement .....	61
9.5.1 Preparing to Measure NIBP .....	61
9.5.2 Starting and Stopping Measurements.....	61
9.5.3 Factors Affecting NIBP Measurement.....	62
9.6 Understanding the NIBP Numerics.....	62
9.7 Changing NIBP Settings .....	63
Chapter 10 Monitoring Oxygen Saturation (SpO <sub>2</sub> ) .....	64
10.1 Introduction.....	64
10.2 Safety Information.....	64
10.3 Apply the Sensor .....	65
10.4 Using Probe and Sensor.....	66
10.5 Understanding the SpO <sub>2</sub> and PR Display .....	68
10.6 Changing SpO <sub>2</sub> and PR Settings .....	68
Chapter 11 Monitoring Temperature.....	69
11.1 Introduction.....	69

11.2 Safety Information.....	69
11.3 Making a TEMP Measurement .....	69
11.4 Understanding the TEMP Display .....	70
11.5 Changing TEMP Settings.....	70
Chapter 12 Screen Display for Remote Observation .....	71
12.1 Default Remote Screen.....	71
12.2 NIBP Screen Display.....	72
12.3 Screen Display with ECG Waveforms only.....	73
12.4 Five Channels Real-time Waveforms and Trends on the Same Screen .....	75
12.5 Parameter Screen .....	76
Chapter 13 Battery .....	78
13.1 Overview .....	78
13.2 Battery Maintenance.....	78
13.3 Battery Recycling .....	79
Chapter 14 Cleaning and Disinfection .....	80
14.1 Cleaning the Device and Accessories .....	80
14.2 Disinfecting the Device and Accessories .....	81
Chapter 15 Maintenance.....	82
15.1 Daily Examination .....	82
15.2 Routine Maintenance .....	82
15.3 ECG Verification .....	83
15.4 Pressure Accuracy Verification .....	83
16 Accessories .....	86
17 Technical Specifications .....	87
17.1 ECG .....	87
17.2 RESP .....	88
17.3 TEMP .....	88
17.4 NIBP .....	88
17.5 SpO <sub>2</sub> .....	89
17.6 Pulse Rate .....	89
17.7 S-T Segment.....	90





17.8 Data Recording .....	90
17.9 Other Technical Specifications.....	90
17.10 Classification.....	90
17.11 Operating Environment .....	91
17.12 Storage .....	91
17.13 Transportation .....	91
17.14 Packaging.....	92
Chapter 18 Troubleshooting .....	93
18.1 No Display on the Screen .....	93
18.2 Excessive ECG Signal Interference or too Thick Baseline.....	93
18.3 No Blood Pressure and Pulse Oxygen Measures .....	93
18.4 System Alarm.....	93
18.5 Alarm Problems .....	93
18.6 Power Supply Failure .....	94
A Alarm Information .....	95
B Status/Error during NIBP Monitoring.....	96
C EMC Compliance .....	97











# Chapter 1 Safety

## 1.1 Safety Information

The safety statements presented in this chapter refer to the basic safety information that the operator of the monitor shall pay attention to and abide by. There are additional safety statements in other chapters or sections, which may be the same as or similar to the followings, or specific to the operations.

-  **Warning:** indicates a potential hazard or unsafe practice that, if not avoided, could result in death or serious injury.
-  **Caution:** indicates a potential hazard or unsafe practice that, if not avoided, could result in minor personal injury or product/property damage.
-  **Note:** provides application tips or other useful information to ensure that you get the most from your product.

### 1.1.1 Warnings

-  **WARNING for PACEMAKER PATIENTS:** Although the pacemaker pulse inhibition function is available in this device, the heart rate meter may continue to count the pacemaker rate during occurrences of cardiac arrest or some arrhythmias. Do not rely entirely upon rate meter ALARMS. Keep pacemaker patients under close surveillance. See this manual for disclosure of the pacemaker pulse rejection capability of this instrument.
-  Disconnect the monitor and sensors from the patient before MRI scanning. Use them during MRI could cause burns or adversely affect on the MRI image or the monitor's accuracy.
-  If uncertain about the accuracy of any measurement, firstly check the patient's vital signs by any alternative means, and then make sure the monitor is functioning properly.
-  The monitor is intended only as an adjunct in patient assessment. It must be used in conjunction with clinical signs and symptoms.
-  Monitoring a single person at a time.
-  The monitor is defibrillation-proof. Verify that the accessories can function safely and normally and the monitor is grounded properly before conducting defibrillation.
-  The monitor is not suitable for use in the presence of flammable anesthetic mixture with air, oxygen or nitrous oxide.
-  Each time the monitor is used, check the alarm limits to ensure that they are appropriate for the patient being monitored.
-  The alarm limit value shall be within the measuring range, or it may disable the alarm system. Please refer to the related chapter for alarm limit range.
-  A HAZARD can exist if different alarm presets are used for the same or similar device in a single area.

- 🔊 Do not silence the audible alarm if patient safety may be compromised.
- 🔊 The monitor is prohibited from applying to those who have severe hemorrhagic tendency or who are with sickle cell disease for they may develop partial bleeding when this monitor is used to take the blood pressure measurement.
- 🔊 All the connecting cables and tubes of the applying parts should be kept away from the patient's cervix to prevent any possible suffocation of the patient.
- 🔊 To prevent the risk of the short circuit and to ensure the ECG signal quality, the device must be properly grounded.
- 🔊 The device should be considered an early warning device as a trend towards patient deoxygenation is indicated, blood samples should be analyzed by a laboratory CO-oximeter to completely understand the patient's condition.
- 🔊 Although biocompatibility tests have been performed on all the applied parts, some exceptional allergic patients may still have anaphylaxis. Do NOT apply to those who have anaphylaxis.
- 🔊 Please peruse the relative content about the clinical restrictions and contraindication.
- 🔊 It is recommended that the clinical operator regularly test device and accessories. And the visual and auditory alarm signal can be checked by intentionally disconnect accessories or by setting it at Demo mode to simulate alarm event.
- 🔊 Do not allow service or maintenance on the device while used in patient.

### 1.1.2 Cautions

- 🔊 All the parts of the monitor should NOT be replaced at will, substitution of a component different from that supplied by the manufacturer might result in measurement error. If necessary, please use the components provided by the manufacturer or those that are of the same model and standards as the accessories along with the monitor which are provided by the same factory, otherwise, negative effects concerning safety and biocompatibility etc. may be caused. No modification of this device is allowed.
- 🔊 The accessories which can be used repeatedly should have a thorough cleanness before it is used to another patient. Please refer to the related chapter for maintenance method.
- 🔊 If the monitor falls off accidentally, please do NOT operate it before its safety and technical indexes have been tested minutely and positive testing results obtained.
- 🔊 Do not immerse the monitor or its accessories in liquid to clean.
- 🔊 The system might not meet its performance specifications if stored or used outside the manufacturer's specified temperature and humidity ranges.

















### 1.1.3 Notes



- 🔊 All combinations of equipment must be in compliance with the standard IEC 60601-1.
- 🔊 Please do not position the device so that it is difficult to connect the plug of the power cord.

- ⚠ After the life cycle of the monitor and its accessories has been met, disposal should be accomplished following national and/or local requirements.
  
- ⚠ If the user requires more information such as circuit diagrams, parts list and product descriptions, for repairs carried out by qualified technical personnel, please contact us.
  
- ⚠ ECG arrhythmia analysis function and S-T segment monitoring have not been CE certified.

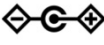
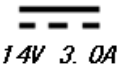







## 1.2 Equipment Symbols

### 1.2.1 Symbol/Icon on the Device

Item	Symbol/Icon	Description
1		Power switch
2		ECG lead key
3		Alarm Silence key
4		Freeze/ Unfreeze key
5		Start/Cancel NIBP measurement
6		Display view key
7		AC power indicator
8		Working power supply indicator
9		Type CF applied parts with defibrillation-proof
10		Warning --- refer to User Manual
11		Type BF applied parts with defibrillation-proof
12		Equipotential grounding terminal
13	SN	Serial number
14		Battery cover
15		USB data cable connector (used for data upload)
16		Network interface (used for connecting to Central Monitoring System)
17	 	Icon of DC power supply socket with polarity indication. DC Power supply socket indication with rated voltage and current.
18		Manufacturer
19		Manufacturing date

20		The following definition of the WEEE label applies to EU member states only. This symbol indicates that this product should not be treated as household waste. By ensuring that this product is disposed of correctly, you will help prevent bringing potential negative consequences to the environment and human health. For more detailed information with regard to returning and recycling this product, please consult the distributor from whom you purchased it.
21		This mark means that this device is fully in conformance with the Council Directive Concerning Medical Devices 93/42/EEC.
22		Authorized representative in the European Community

## 1.2.2 Icons List on the Screen

Icon/info.	Description
	Alarm sound is mute/off
	Waveform frozen symbol
	Cross cursor for S-T segment measurement
	Heart-beat symbol
	Breath symbol
	AC Power supply and the battery is fully charged.
	The red blinking exclamation mark means battery will be used out soon and needs to be charged. Alarm information area will show "Low Battery" message.
	Charging status
	One/two/ full grid battery voltage left
S-T +.....	The measured S-T value
PI	Perfusion index
%	Unit of SpO <sub>2</sub>
mmHg/kPa	Unit of blood pressure
Bpm	Unit of heart rate or pulse rate
rpm	Unit of respiration rate
°C/°F	Unit of temperature

mm/s	Unit of waveform sweeping speed
------	---------------------------------

NOTE: some symbols may not appear on your equipment

## Chapter 2 The Basics

### 2.1 Monitor Description

#### 2.1.1 Product Name and Model

Product name: Patient Monitor

Product Model: See Label in page I

#### 2.1.2 Intended Use

This Patient Monitor is a multi-functional instrument designed for monitoring the vital physiological signs of adult, pediatric and neonate patients. With the functions of real-time recording and displaying parameters, such as ECG, heart rate (HR), non-invasive blood pressure (NIBP), functional oxygen saturation (SpO<sub>2</sub>), respiration (RESP), body temperature (TEMP), as well as the optioned monitoring functions, it allows comprehensive analysis of patient's physiological conditions.

Note: This patient monitor can be configured with different parameters, the monitor you purchase may not cover all functions described above.

- This device is applicable for use in hospitals and clinical institutions. The operation should be performed by qualified professionals or under their guidance. Anyone unauthorized or untrained must not perform any operation on it.
- The physiological waveforms and parameters and the alarm information displayed by the monitor are only for the reference of operators, but cannot be used directly to determine the clinical treatment.

Contraindication: please see each section.

#### 2.1.3 Features

This patient monitor can be used to monitor patient's physiological parameters including ECG, heart rate (HR), non-invasive blood pressure (NIBP), oxygen saturation (SpO<sub>2</sub>), Pulse rate (PR), respiration and temperature. It has the following features:

- ✧ It is lightweight, easy to carry and operate;
- ✧ 7" high-resolution (800 × 480 pixel) color TFT (refer to the monitor you purchased) to display multiple traces of signal waveforms for ECG, plethysmogram and respiratory waveform;
- ✧ User-friendly and intuitive display interface, multiple configuration of ECG waveform display:

Main monitoring screen view: displays the information of main waveforms and parameters visually.

Observing screen view: heart rate value and SpO<sub>2</sub> value display in big fonts, and displays one trace of ECG waveform.



Seven traces of ECG waveforms on one screen view: displays 7 traces of ECG waveforms for different leads and monitoring parameters simultaneously on one screen.

Five channels of real-time waveforms and two hours' trends screen view: intuitive knowing the physiological status of patient.

oxyCRG screen: displays heart rate trend, SpO<sub>2</sub> trend, respiration trend or waveform simultaneously on oxyCRG screen, to know the instantaneous the change of physiological parameters of respiration.

- ✧ The cuff can be also used as a tourniquet, which is convenient and practical in use as an additional function, and different cuff pressure can be set according to patient's condition.
- ✧ Automatic analysis of 20 types of arrhythmia, manual measurement of S-T segment while ECG waveform frozen or automatic measurement while monitoring;
- ✧ Up to 1000 hours trend data storage for parameter of ECG, S-T, TEMP, SpO<sub>2</sub>, RESP and NIBP;
- ✧ Up to 2000 groups of arrhythmia events' can be stored, as well as the corresponding HR , TEMP, SpO<sub>2</sub>, and RR;
- ✧ Up to 12000 groups of NIBP measurement can be stored, as well as the corresponding HR, TEMP, RR SpO<sub>2</sub> and PR while the blood pressure measurement is taken, it can be recalled by list table or graphic trend.
- ✧ Up to 60 hours of ECG waveform storage (non-volatile) and can be reviewed;
- ✧ Accurate NIBP measurement with over-pressure protection;
- ✧ Unique pulse oximetry technique achieves accurate SpO<sub>2</sub> and PR measurement;
- ✧ Visual and audible alarm, recall of alarm events;
- ✧ Flexible high and low alarm limits setting operation;
- ✧ Real-time monitoring of battery capacity, when the battery power is insufficient, low battery voltage alarm indication will display on LCD screen.
- ✧ Easy to configure the display color, font and waveforms layout for user customization;
- ✧ Protection against defibrillator discharge and resistance against the interference from electro-surgical unit;
- ✧ Pacemaker pulse detection and inhibition functions are available;
- ✧ Patient type can be selected among "Adult", "Pediatric" and "Neonate" in setup menu;
- ✧ Optional networking capability for connecting to the central workstation;

Note: This patient monitor can be configured with different parameters, the monitor you purchase may not cover all functions described above.

## 2.2 Main Unit

### Front Panel

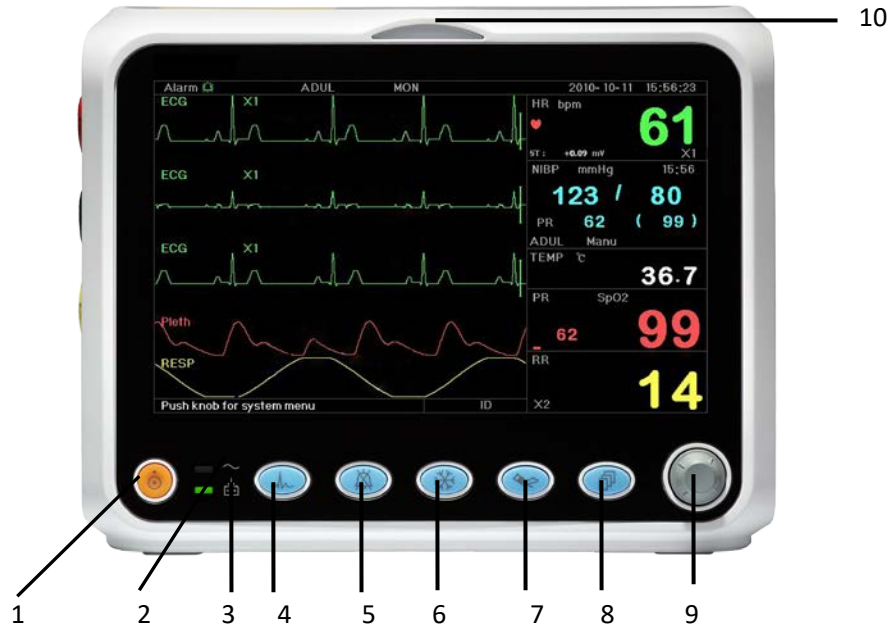







Figure 2.1 Front Panel

**Note:** The appearance described in this manual may be a little different with the monitor you purchased, for example, the operation keys may be located at the right side of the front panel. But the operating procedure is the same. Therefore, please refer to the monitor in your hand for details.

1. **Power switch:** Press it for 3 seconds to start the monitor or turn off the monitor.
2.  **AC power indicator:** When it is light it means that AC power supply is being used
3.  **Built-in DC power indicator:**



When both AC and DC indicators are on, it means that AC power supply is applicable, and the battery is being recharged. If only DC indicator is on, it means that the battery is being used.

4.  **ECG lead:** Press to shift the ECG lead circulatory among I, II, III, aVR, aVL, aVF and V.
5.  **Alarm silence:** Press  key to enable or disable the system alarm silence function. During the monitoring process, when an alarm event activates the system alarming, press "Alarm silence" key, then the system alarm sound will be muted temporarily for 2 minutes. If a new type of alarm event occurs during this silent period, the alarm sound will be resumed automatically to give audible alarm. If the alarm event which triggers this alarming persists after the period of 2 minutes silence, the system alarm sound will be activated as well.

The maximal period of alarm silence is 2 minutes.

6.  **Freeze:** Press the key to freeze/unfreeze ECG waveform or the waveforms of ECG, SpO<sub>2</sub> and RESP

according to the device setting, and enter into ST segment measurement screen for analysis (on Observing Screen).

7.  **NIBP:** Press to start or stop NIBP measurement.
8.  **DISP:** Click to shift the display modes or return to the Main Screen from other screens. Press it to shift between Main Screen and Display 2 Screen which can be set in System Menu screen.
9. **Navigation Knob:** It is the major operating key of the system, which can be used to select functions or parameters. Press and release it to shift the screen and to confirm the function or other operating tips.
10. **Alarm indicator:**

Indicator Color	Alarm Level	Alarm Event
Red flashing	High priority alarm	Parameter exceeding the limits, asystole or apnea
Yellow flashing	Middle priority alarm	Leads and probe off, VE RONT and SVE RONT
Yellow light	Low priority alarm	Other arrhythmia events
Green light	Normal	

## Left and Right Panel



**Figure 2.2** the left panel



**Figure 2.3** the right panel

Different ports are located in different positions of the monitor for operating convenience.

The cable and transducer ports are on the left panel, shown in Figure 2.2.



- ✧ SpO<sub>2</sub>: SpO<sub>2</sub> probe connector
- ✧ NIBP: NIBP hose connector
- ✧ TEMP: TEMP probe connector
- ✧ ECG/RESP: ECG cable connector
- ✧ Symbol definition

 With type BF applied parts and applicable during the defibrillator is used.

 With type CF applied part and applicable during the defibrillator is used.

 Caution. Please read the manual for details.

The power supply socket and ports are at the right panel, shown in Figure 2.3.

1.  : DC Power supply socket indication with rated voltage and current
2.  : Serial communication port which is used to network with central monitoring system (optional).
3.  : USB port (used for data uploading). The user can upload data from the monitor to the PC directly by connecting the specified USB data cable (optional) between the patient monitor and PC. If the data cable is well connected between the PC and the Patient Monitor, the Patient Monitor will be recognized automatically by PC as a disk device and prompt information will appear on the computer, a removable disk named "PC-3000" appears on "My computer". Double click this disk, you can see a data file which will be found out and retrieved later during the data uploading.

Meanwhile, at the Patient Monitor side, the message "Data upload mode" will appear on its display screen.

4.  : Icon of DC power supply socket with polarity indication .

## Rear Panel

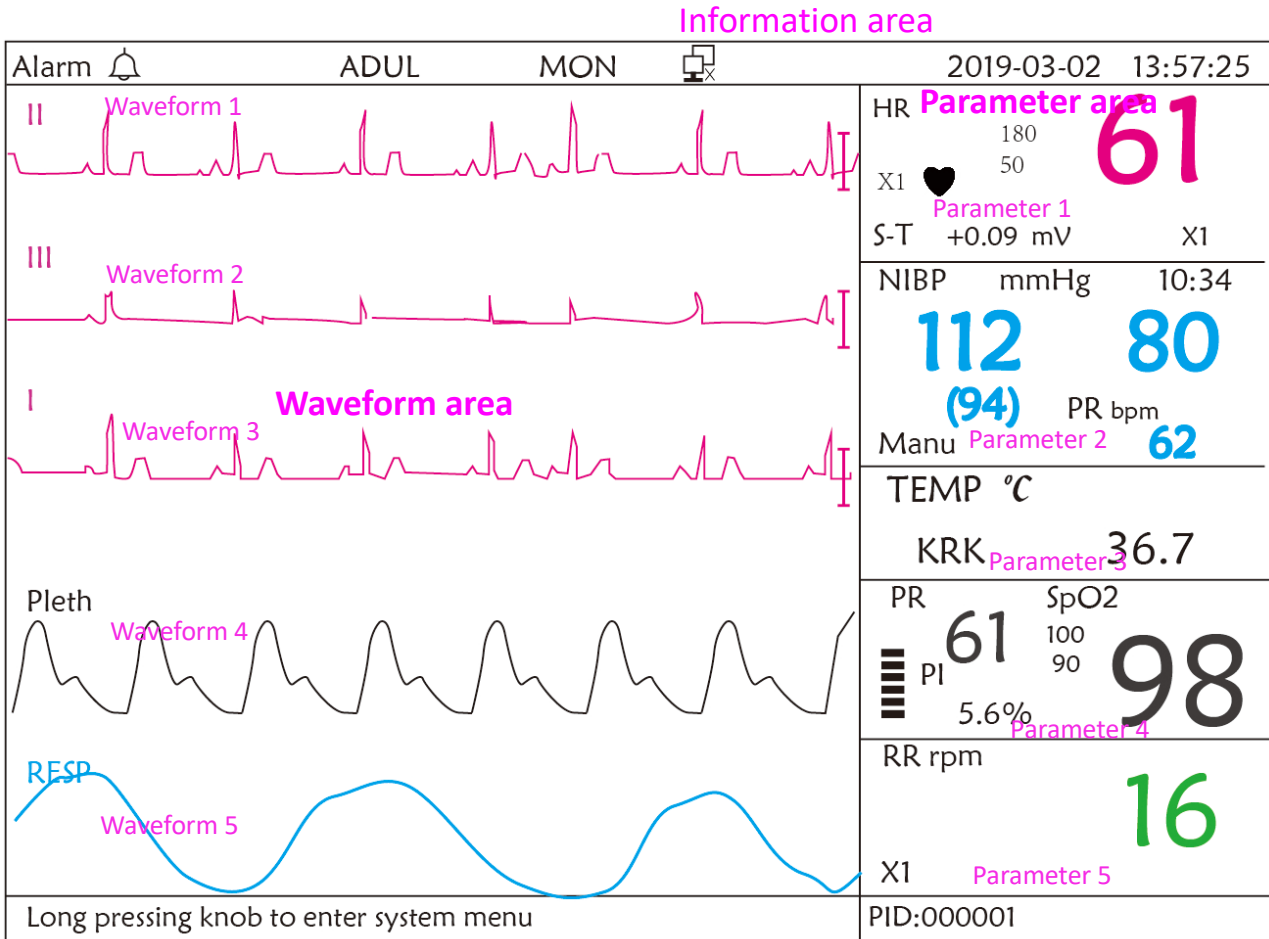

**Figure 2.4** Rear panel

## 2.3 Display Screen

Generally, when there is no pop-up window on the screen, the screen layout of the device includes information area, Waveform area and Parameter area, as shown in below Figure. Information area is on the top of the screen; Parameter area is on the right of the screen and Waveform area is on the left.

When a new window pops up, this will become is the current operable window displayed on top layer. To return to the main screen press the Disp. button “”.







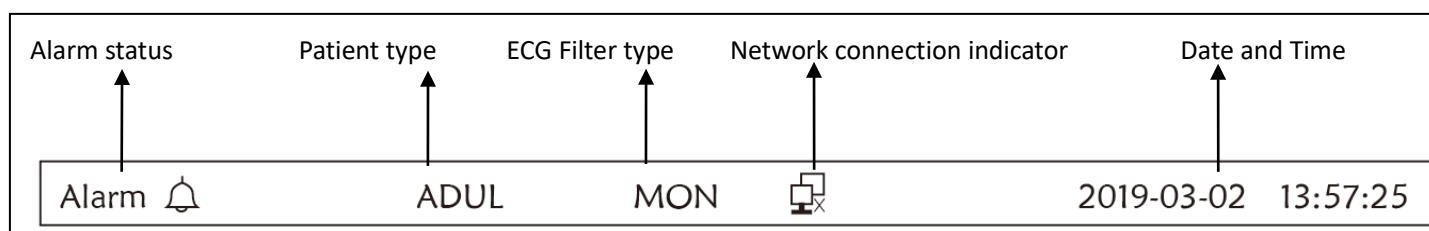

Screen layout (refer to actual screen)

## 2.3.1 Information Area

The Information Area will display the patient information (including gender, patient ID, patient type and name), physiological alarm sources, alarm sound status and current date.



- ✧ **“Alarm  indicates the audible alarm is enabled, yellow  indicates the alarm sound is silent. The audible alarm will be activated again automatically after 2 minutes or when a new alarm event occurs. Red  indicates the audible alarm is disabled, that means the alarm sound is off, this is also normal situation when the alarm sound volume is set to “0” in system parameter settings.**
- ✧ **“ADUL”**: The patient type. There are two types available: “Adult” and “Pediatric”.
- ✧ **“MON”**: ECG Filter type. There are three types: “Diagnosis”, “Monitor” and “Operation”. The option can be set in the setting menu.
- ✧  : network connection indicator. "  " means the patient monitor is not linked with the central monitoring system yet; "  " (in green) means the patient monitor is linked to the central monitoring system successfully.
- ✧  : battery voltage indicator; When the indicator is yellow and displays only one “grid”, it means there is a little battery power left. When the indicator turns red and blinks, as well as less than one “grid” displays, the system alarm will be on to remind the low battery voltage. Please connect the device to the mains power supply in time to ensure the normal use of monitor, and the battery will be recharged. When the battery is fully charged, battery voltage indicator displays full grid. During recharging, the grids in the battery indicator are rolling circularly.
- ✧ **“2011-03-02 13:57:25”**: the current calendar time and date. The system time and date can be set during the system start-up when the screen displays the time and data setups. The current figure shows the time and date is March 2<sup>nd</sup>, 13:57:25, 2011.
- ✧ **“Long press knob to enter System Menu”**: System prompt or description for the current status.
- ✧ **“PID”**: The patient ID. The patient ID can be entered or changed in the archive management window

## 2.3.2 Parameter Area and Waveform Area

### 1) Parameter Area

Parameter area displays each parameter's value, unit and icon etc.. Move Navigation Knob to focus a certain parameter panel, and the panel (such as ECG parameter panel shown in below figure) will be highlighted, then press Knob can enter into the corresponding parameter setting screen.

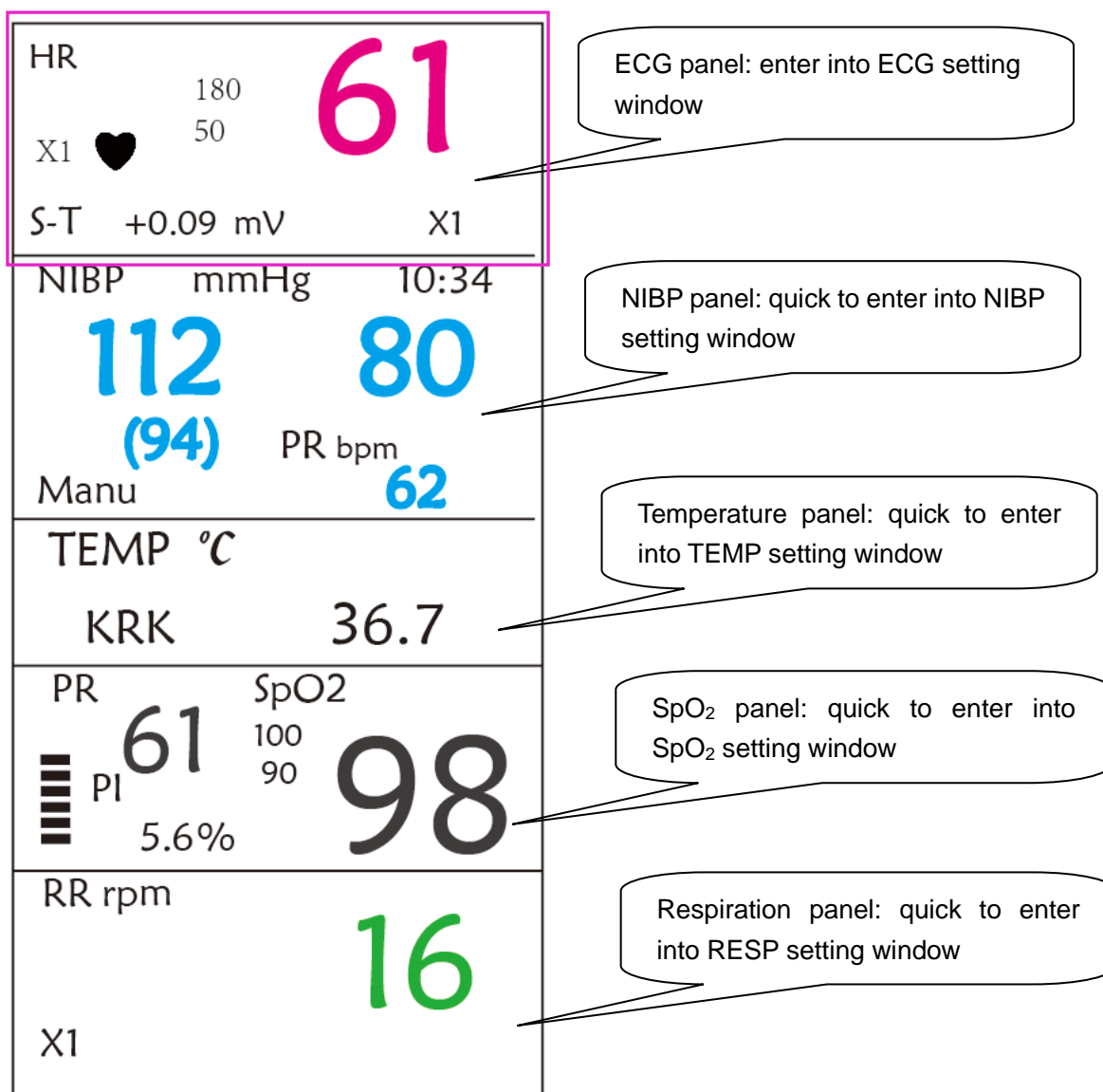





## 2) Waveform area

- ✧ 1<sup>st</sup> trace: The first trace is ECG waveform for lead II. The left side of the ECG waveform shows the scale bar looking like "I", which indicates the ECG scale. This scale bar will change its height according to the ECG gain setting. All ECG waveforms have their own scale. When the third trace of ECG waveform changes to lead II, the first trace will automatically change to ECG waveform for lead I.
- ✧ 2<sup>nd</sup> trace: The second trace is for the ECG waveform of lead III. When the third trace displays the ECG for the lead III, this trace automatically changes to the ECG for lead I.
- ✧ 3<sup>rd</sup> trace: Its lead can be adjusted and will not repeat the 1<sup>st</sup> and 2<sup>nd</sup> traces.
- ✧ 4<sup>th</sup> trace: Plethysmogram for SpO<sub>2</sub> measurement
- ✧ 5<sup>th</sup> trace: Respiration waveform.







## Chapter 3 Operations

### 3.1 Installation

-  Devices connected to the equipment must meet the requirements of the applicable IEC standards. The system configuration must meet the requirements of the IEC 60601-1-1 medical electrical systems standard. Any personnel who connect devices to the equipment's signal input/output port are responsible for providing evidence that the safety certification of the devices has been performed in accordance with IEC 60601-1-1. If you have any question, please contact the manufacturer or your local dealers.
-  If it is not evident from the equipment specifications whether a particular combination with other devices is hazardous, for example, due to summation of leakage currents, please consult the manufacturers or else an expert in the field, to ensure the necessary safety of patients and all devices concerned will not be impaired by the proposed combination.
-  The equipment shall be installed by personnel authorized by manufacturer.
-  The software copyright of the equipment is solely owned by the manufacturer. No organization or individual shall resort to modifying, copying, or exchanging it or to any other infringement on it in any form or by any means without due permission.

#### 3.1.1 Unpacking and Checking

1. Open the package, take out the monitor and its accessories from the box carefully and place it in a safe stable and easy to watch position.
  2. Open the user manual to sort the accessories according to the packing list.
    - ✧ Inspect the accessories for any mechanical damages
    - ✧ Check all the exposed leads and inserted accessories
    - ✧ Check whether any risk or abnormality exists in the device and its accessories before using the monitor. If any abnormality (such as broken cable or crack of the enclosure etc.) is found, stop using this device.
-  When disposing of the packaging material, be sure to observe the applicable waste control regulations and keep it out of children's reach.
  -  Before use, please verify whether the package are intact, especially the packages of single use accessories. In case of any damage, do not apply it to patients.
  -  Save the packing case and packaging material as they can be used if the equipment must be reshipped.
  -  The user can customize the module configuration by choosing necessary modules to meet your own needs. Therefore, your monitor may not have all the monitoring functions and accessories.

Please contact the local dealer or our company in case of any problems. We will offer the best solution for your satisfaction.

#### 3.1.2 Environmental Requirements

The operating environment of the equipment must meet the requirements specified in this manual. Otherwise, unexpected consequences, e.g. damage to the equipment, could result.

The environment where the equipment is used shall be reasonably free from noises, vibration, dust, corrosive, flammable and explosive substances. If the equipment is installed in a cabinet, sufficient space in front and behind shall be left for convenient operation, maintenance and repair. Moreover, to maintain good ventilation, the equipment shall be at least 2 inches (5cm) away from around the cabinet.

When the equipment is moved from one place to another, condensation may occur as a result of temperature or humidity difference. In this case, never start the system before the condensation disappears.

## 3.2 Getting Started

### 3.2.1 Connecting to Power Source

#### 1. Using AC Power Source

- ◆ Make sure that the AC power supply is (100-240)VAC, 50Hz/60Hz.
- ◆ Use the power cable provided by the manufacturer. Insert one end of it to the AC power input of the monitor and the other end to the three-pin outlet of the power source with protected-earth.
- ◆ To eliminate potential differences, the monitor has a separate connection to the equipotential grounding system. Connect one end of the provided ground wire to equipotential grounding terminal on the rear of the monitor, and connect the other end to one point of the equipotential grounding system.

**Caution: 1. Ensure that the monitor is grounded correctly.**

**2. If you have any doubt to the grounding layout and its performance, you must use the built-in battery to power the monitor.**

 After the mains power supply has been interrupted while power switch remains in the “on” status and is restored after a period of time that is longer than 30 seconds, the monitor will run by the last settings when restarting the monitor.

 The monitor is applicable to connect to the public mains power network.

#### 2. Using Battery

The following steps should be followed to install the battery:

Step 1: open the battery cover;

Step 2: pull out the battery cable and connect it to the battery pack;

Step 3: push the battery pack into the battery compartment and lock it;

Step 4: close the battery cover.

**Caution: it's better to recharge the battery after it is used up, and the charging time should be 12~15 hours long.**

**Battery life:** Provided that a battery is new and fully charged, the minimal working time of the monitor with accessories connected is declared in the table below:

Name	Battery life
Patient Monitor	More than 120min

**NOTE:** when the device is working, It takes at least 10 hours to charge battery from exhaust state to 90% charged.

-  The provided battery of the monitor must be recharged after transportation or storage. So if the monitor is switched on without being connected to the AC power supply, it may not work properly due to insufficient battery power.





: Working power supply indicator and the description is as shown below.

	AC power indicator	Working power supply indicator	Description
Status	On	Off	The monitor is powered by the AC power supply and it is in off status
	Off	On	The monitor is powered by the build-in battery power supply
	On	On	The monitor is powered by the AC power supply and the battery is being charged

### 3.2.2 Turning the Monitor On

The system performs self-test and enters initial display after switch on the monitor, and the alarm rings to inform that the user can begin operating the monitor.

1. Check all the applicable functions to make sure that the monitor works normally.
  2. If the built-in battery is applied, please recharge it after using the monitor to ensure sufficient power storage. It will take at least 10 hours to charge battery from depletion to 90% charge.
  3. Press the Power on/off key on the front panel of the monitor to start the monitor.
-  Do not use this device to monitor the patient if there are indications of damage or reminders of error. Please contact the supplier for device.
  -  The battery powered monitor continues to run without interruption when AC mains power is lost.
  -  When the monitor is switched off allow one minute before switching it back on so that the monitor powers off correctly.

### 3.2.3 Starting Monitoring

1. Decide which parameter measurements you want to make.
2. Connect the required modules, patient cables and sensors.
3. Check that the patient cables and sensors are correctly connected.
4. Check that the patient settings, such as Patient Type, NIBP measuring mode, etc, are appropriate to your

patient.

Refer to the corresponding Section for details of how to perform the measurements you require.

### 3.3 Turning the Monitor Off

To disconnect the monitor from the power, follow this procedure:

1. Confirm that patient monitoring is complete.
2. Disconnect patient cables and sensors from the patient.
3. Make sure to save or clear the monitoring data as required.
4. Press the Power on/off key on the front panel to turn off the monitor.

 Although not recommended, you can press and hold the Power on/off key for 10 seconds to forcibly shut down the monitor when it can not be shut down normally or under some special situations. This may cause loss of data of the monitor.

### 3.4 Using Keys

#### 3.4.1 Shortcut Key

Refer to Section 2.2 for details.

### 3.5 Using the Main Menu

To enter the main menu by Longtime pressing the “Navigation Knob” in the default screen, the System Menu screen will display in the lower left area on the screen, as shown in Figure 3.1. Most of the monitor’s operations and settings can be perform through the main menu.

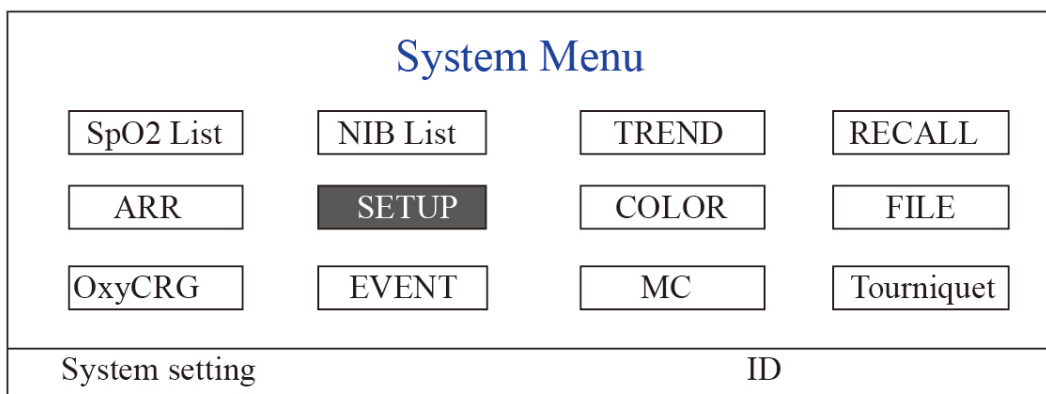



Figure 3.1

**Note:** some of the above mentioned functions are for optional, so your monitor may not cover all functions, please refer to the monitor in your hand.

#### 3.5.1 How to Select the Menu Item

**Step 1:** rotate the knob to move the gray cursor to the corresponding item.

**Step 2:** press the knob to enter the corresponding screen: SpO<sub>2</sub> Data List Screen, NIBP Data List Screen, Graphic Trend Screen, Recall Screen, Arrhythmia Screen, System Setup Screen, Color Settings, File/Archive Management Screen, oxyCRG Screen, Event List Screen, MC Calculator Screen or Cuff (Tourniquet Function) Screen. The following chapters will describe each one respectively.

Pressing “” key to return to the Main Screen.

Note: For the monitor without ECG function, “RECALL”, “ARR” and “OxyCRG” are in grey and non-accessible. And MC Calculator Screen or Cuff (Tourniquet Function) Screen are not available.

## 3.6 Data Uploading

The data stored in this device can be uploaded to the computer via the optionally provided USB data cable for data management and review.

### ◆ Procedure of Data Upload

Step 1: Download the PC software “Patient Monitor Data Manager” from website ([www.creative-sz.com](http://www.creative-sz.com)).

Step 2: Install the software “Patient Monitor Data Manager” on your computer.

Step 3: Connect the Patient Monitor and computer by the provided data cable, refer to the below figure.

Step 4: Double-click the shortcut “” on your computer to start running the “Patient Monitor Data Manager”.

Step 5: Click “Data Upload” button to acquire data.

Please refer to the “Patient Monitor Data Manager” user manual for further instructions. This can be found in the help section of the software. Please contact the manufacturer or your local distributor if you have any queries regarding to downloading or running the software.

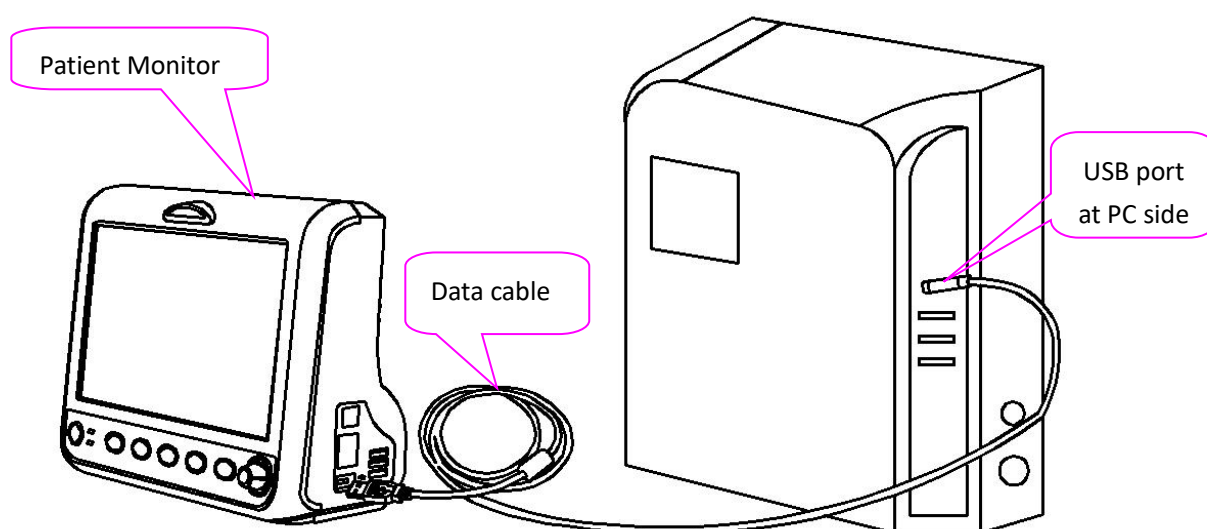

Connection between patient monitor and computer

## Chapter 4 Screen Display

### 4.1 SpO<sub>2</sub> Trend Data List Screen

PID	Date/Time	HR	RR	TEMP	SpO <sub>2</sub>	PR
000001	03-02 13:57	66	15	37	99	65
000001	03-02 14:57	66	16	37	98	66
000001	03-02 15:07	68	16	37	99	67

Figure 4.1 SpO<sub>2</sub> Trend Data Listing Screen

#### 4.1.1 Screen Description

When monitoring, the newest data will be displayed on the top of list including "Time, HR, RR, TEMP, SpO<sub>2</sub>, PR". The time shows the time when the SpO<sub>2</sub> measurement was taken. Up to 6 groups of SpO<sub>2</sub> data can be displayed on one screen. There is only one record every 4 seconds.

#### 4.1.2 Operating Instructions

Up to 400 groups of SpO<sub>2</sub> data can be memorized. Using the Navigation Knob allows the user to scroll the list up and down to view SpO<sub>2</sub> data. When rotating the knob anti-clockwise, the list scrolls upward. When rotating knob clockwise, the list scrolls down. Please note that when the groups of data are less than 6, the Navigation Knob can not be used to scroll up or down the listing.

Pressing " " key to return to the Main Screen.

### 4.2 NIBP Data List Screen

PID	Date/Time	NIBP	RR	HR	SpO <sub>2</sub>	PR
000001	03-02 13:57	126/81/(97)	15	66	99	65
000001	03-02 14:57	126/81/(97)	15	66	99	65
000001	03-02 15:07	126/81/(97)	15	66	99	65

Figure 4.2 NIBP Data List screen

#### 4.2.1 Screen Description

When monitoring, the newest data will be displayed on the top of list including "Time, NIBP, PR, HR, RR, TEMP". The time shows the time when the NIBP measurement was taken. Up to 6 groups of NIBP data can be displayed on one screen. There is only one record every 4 seconds.

## 4.2.2 Operating Instructions

Up to 12000 groups of NIBP data can be memorized. Using the Navigation Knob allows the user to scroll the list up and down to view NIBP data. When rotating the knob anti-clockwise, the list scrolls upward. When rotating knob clockwise, the list scrolls down. Please note that when the groups of data are less than 6, the Navigation Knob can not be used to scroll up or down the listing.

Pressing " " key to return to the Main Screen.

## 4.3 Screen Display for Graphic Trend

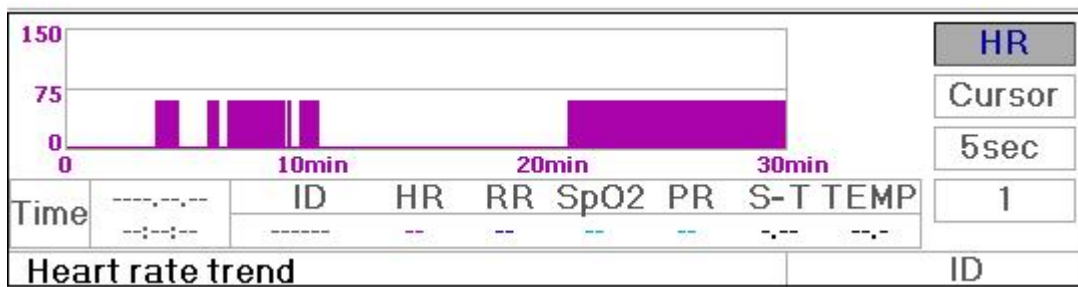

Figure 4.3 HR Trend Graph

### 4.3.1 How to View the Graphic Trend

Figure 4.3 is the HR trend graph. There are 3 options on the right of the graph, as described below.

"HR" indicates the current trend graph is HR trend graph. If you want to enter other trend graphs, the procedures are: move cursor to "HR" and rotate the "Navigation Knob" to choose the trend graph from "HR", "S-T", "Temperature", "NIBP", "PR", "RR" and "SpO<sub>2</sub>" trend graphs, next press the knob to confirm. Their screens are described in the following figures.

After choosing "Cursor", the trend graph will display a triangle and a vertical line, a moving ruler mark that can be moved by rotating the knob. As shown in the figure, when you move the cursor to a specific point, the data area below the graph will display the timestamp, and its corresponding heart rate, respiration rate, SpO<sub>2</sub> and temperature. When rotating "Navigation Knob" key to move the cursor, the moving step is a variable value depending on the dialing speed. The rule is that the initial step is 5sec, after moving it towards the same direction 1 time, the step becomes 30 sec, and with more steps the step becomes 1min, 10min and 30min.. Therefore, it is very easy to find the time point you are looking for.

The "5 sec" on the top shows the interval time. Move the focus to the trend time, press the knob and rotate it, and the trend graph time will change to 30 sec, 1 min, 10 min, 30 min, which changes the horizontal axis to be 30 min, 3 hour, 6 hours, 60 hours, 180 hours. For example, the monitoring can record 360 times data continuously when setting to "5 sec" within 30 minutes. Changing the interval time of 30 seconds, it can record 360 times data within 3 hours. Other changes are similar to that situation.

The Trend graph shows parameter value of the current time. For example, in the "5 sec" trend graph, the monitoring can record the current data with the interval of 5 seconds. Once the monitor is out of power, the data can be stored automatically and you can scan the history record when turning on the monitor next time. This ensures the screen will always display the current data continuously. Other trend graph follows the same rule.

Please note that the maximum value on the vertical axis of the HR is 150, not the value of HR upper limit (300). The graph is scaled down for better view of the trend curve. When the HR value exceeds 150, the vertical axis's maximum value will automatically change to 300. That is to say, the vertical axis value 0-75-150 will change to 0-150-300 automatically if the ECG value exceeds 150. When the monitor is reset or the patient ID is changed, the vertical axis will return to its original value of 0, 75, and 150. Other changes of vertical axis value in other trend graph are similar to that of HR.

The respiration rate, body temperature and other trend graph are similar to that of HR's and we will not cover them in detail again. Please note that for NIBP trend graphs, the horizontal axis is the sequence number of times the blood pressure measurement instead of timestamp.

NIBP graphic trend is a little different from the other graphic trends. Rotate the knob to move the cursor to "

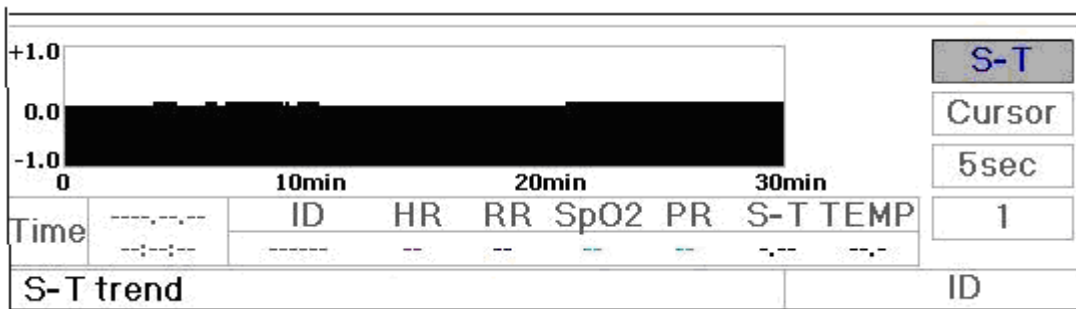

Figure 4.4 S-T Segment Trend Graph

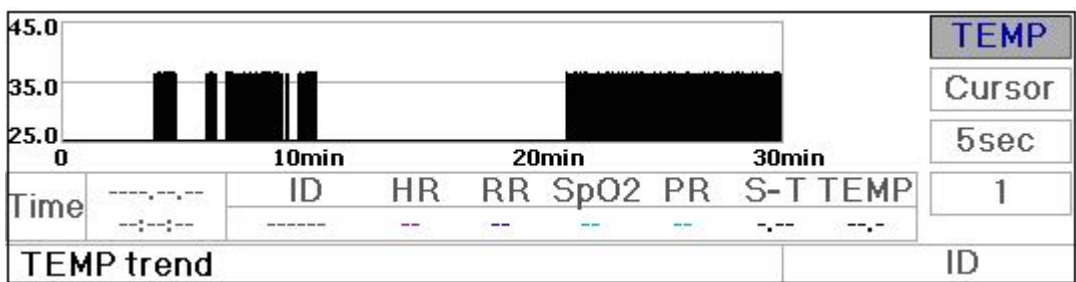

Figure 4.5 Body Temperature Trend Graph

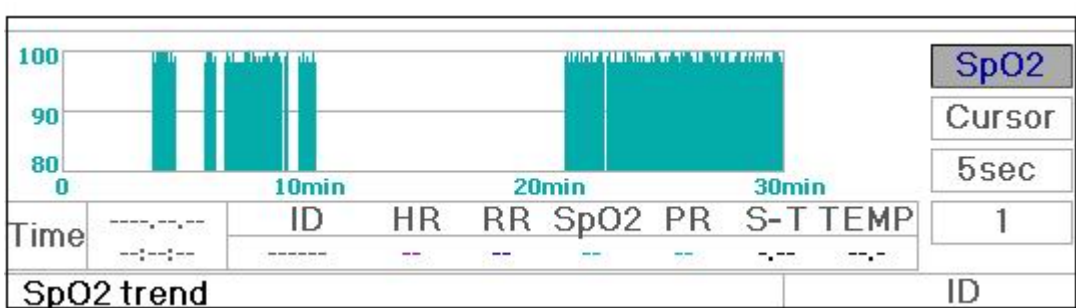



Figure 4.7 SpO<sub>2</sub> Trend graph

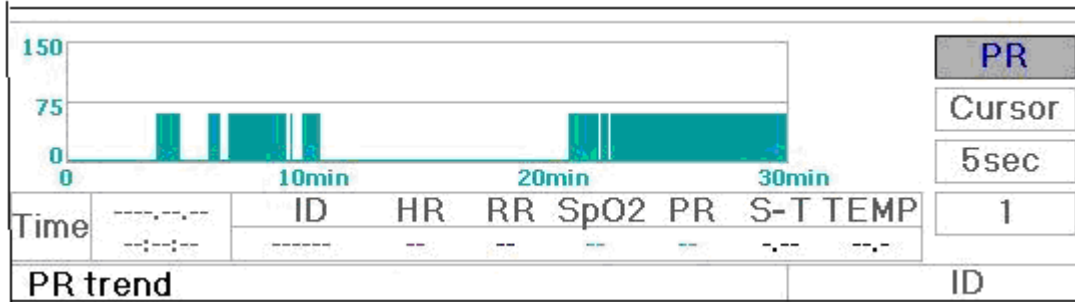

Figure 4.8 PR Trend Graph

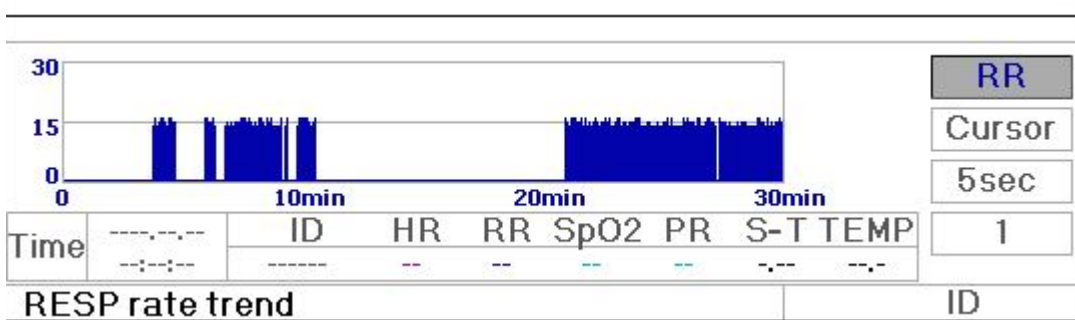



Figure 4.9 Respiration Trend Graph

### 4.3.2 Operation Instructions

Rotate the Navigation Knob to choose the parameter and press the knob to review the trend graph.

Pressing “” key to return to the Main Screen.

### 4.4 Screen Display for Waveform Recall

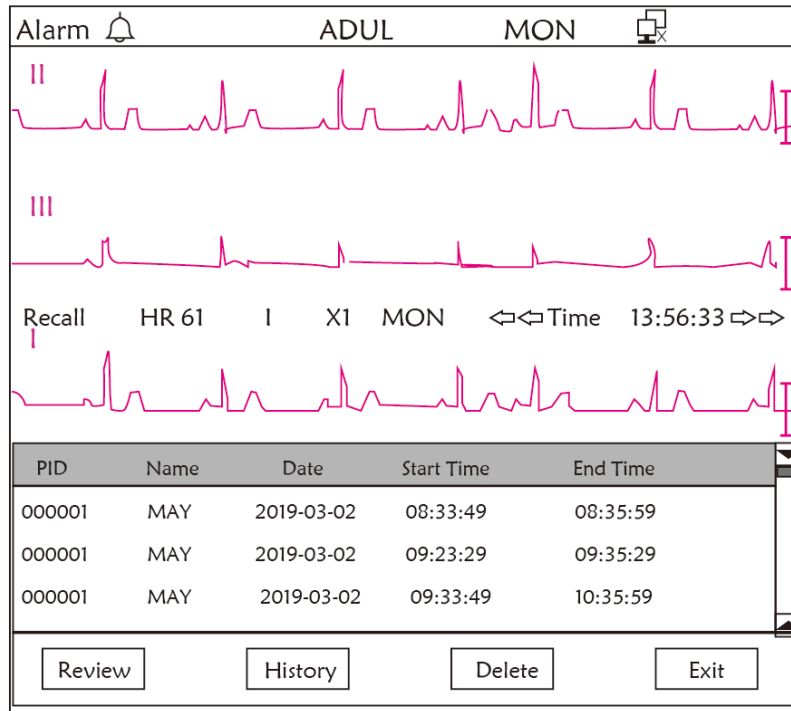

**Figure 4.10 Waveform Recall Screen**

It shows the monitoring can recall the history data continuously. If you change the patients' ID or the monitor is out of power, the measuring data will not being a new single record, but connect to the last record you have measured. It is a continuous record.

The ECG lead, gain and other parameters will not change during recall.

Shown in Figure 4.11, it is different from the Main Screen in its 3<sup>rd</sup> waveform area and the operation area. We will explain them in detail below.

PID	Name	Date	Start Time	End Time
000001	MAY	2019-03-02	08:33:49	08:35:59
000001	MAY	2019-03-02	09:23:29	09:35:29
000001	MAY	2019-03-02	09:33:49	10:35:59

Review History Delete Exit

**Figure 4.11 Recall Listing**

#### 4.4.1 Operation Instructions

Rotate the "Navigation Knob" and choose "Recall", "HIST", "Delete" or "Exit". We explain the functions of each button below.

**Recall:** Press Recall and the first record in recall list becomes green. Rotate the knob to choose a record, and press the knob to recall it. The recalled waveform is displayed on the 3<sup>rd</sup> trace of the waveform area, as shown in Figure 4.12.

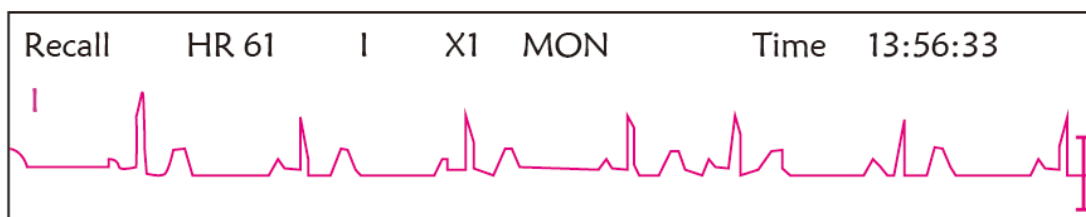

**Figure 4.12 Recalled ECG Waveform**

Rotate the “Navigation Knob” to move forward or backward to review the ECG waveform. Press the “Navigation Knob” to exit the ECG waveform recall and return to the initial ECG waveform recall screen.

During ECG waveform recall, the monitor not only displays the current recalled waveform, but also displays the setting of ECG lead, gain and filter type for the recalled waveform and timestamp.

**HIST:** Press the key to shift between the History key and Current key. Press HIST and the recall list on the left displays the history data list. Press the Current, the recall list on the left side displays the current one. When entering the recall screen display, the monitor defaults the current one.

**Delete:** Press this key, and the selected record in the recall list becomes green. Rotate the “Navigation Knob” to choose the reviewed record that is to be detected, press it longer than 2 seconds and release it, then the record will be deleted. The current record cannot be deleted, or the monitor will exit Delete screen

**Exit:** Press this key to return to the System Menu screen.

## 4.5 Screen Display for Arrhythmia Event List

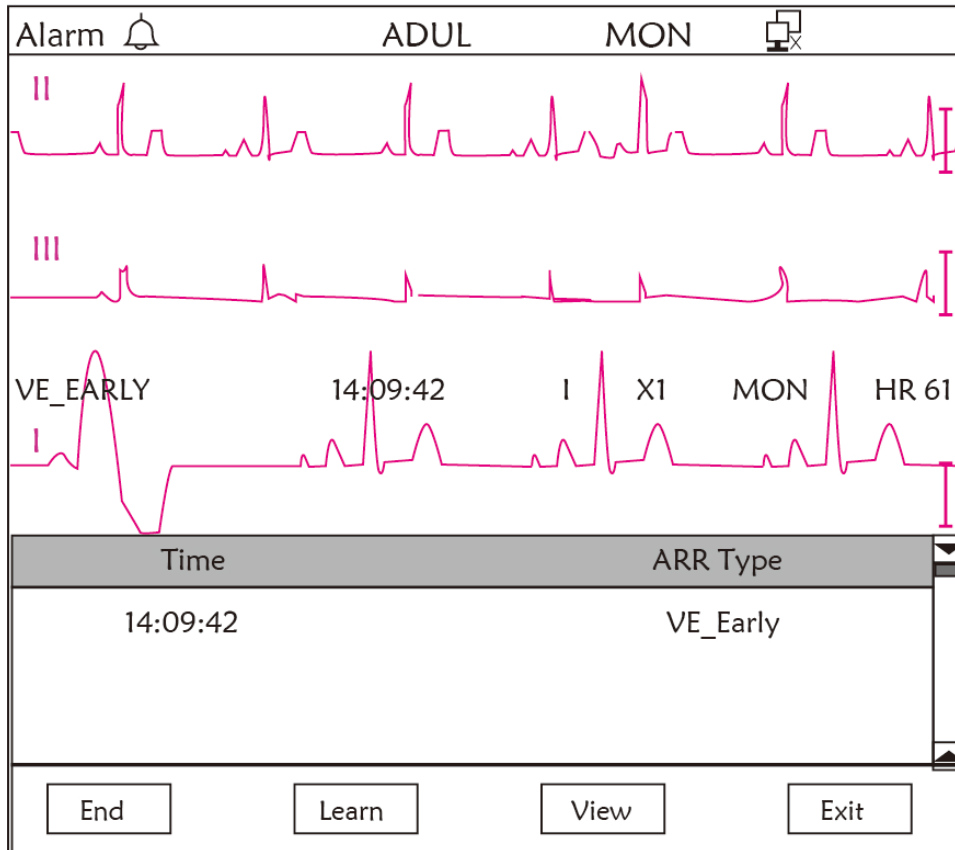

Figure 4.13 Arrhythmia Event List Screen

### 4.5.1 Operation Instructions

The structure is similar to the recall screen. We will cover each function key below.

**Start:** This button is used to start and end the system Arrhythmia detection. The default is OFF. When the Arrhythmia is not ON, the “Learn” key is disabled. Press this key and the monitor enters learning stage before detecting arrhythmia. The “Start” changes to “End”. Press it again to end the learning. When “Learn” key change to yellow from gray, it indicates the learning has finished. When the ARR detection begins after learning, the monitor will automatically detect the ARR event. If an ARR event is detected, the ECG waveform with corresponding ARR event will be displayed in the 3<sup>rd</sup> trace of waveform, shown in Figure 4.13.

When the monitor get Reset or the patient ID has been changed, the ARR detection needs to be re-learned.

**Learn:** Because the Arrhythmia detection is based on the pattern of normal ECG waveform, which is built up during learning stage. When the patient changes, the ARR detection could be incorrect, so re-learning is needed. To get better result of the learning function, it is recommended to start learning while a segment of good quality ECG waveform appears during the ECG monitoring.

**View:** Press this key, and the selected record in the Arrhythmia event list, which is to be reviewed, becomes the green. Rotate the “Navigation Knob” to choose the record and display the corresponding waveform in the 3<sup>rd</sup> trace of waveform. Press the knob again to exit.

**Exit:** press this key to exit the Arrhythmia detection screen and return to the System Menu screen.

During monitoring, if an ARR event is detected, the monitor will alarm. The ARR alarm is system default and does not need setup.

During ARR detection, incorrect detection might occur if the large interference signal (e.g. square pulse or triangle pulse) appear.

Before starting 1mV calibrating signal selection, please turn off the ARR detection.

During ARR detection, the learning template is very important. The monitor requires a segment of stable and clean ECG waveform. If the monitor detects the ARR event incorrectly, please do re-learn by pressing "Learn" button again for capturing good template.

## 4.6 Screen Display for System Setting

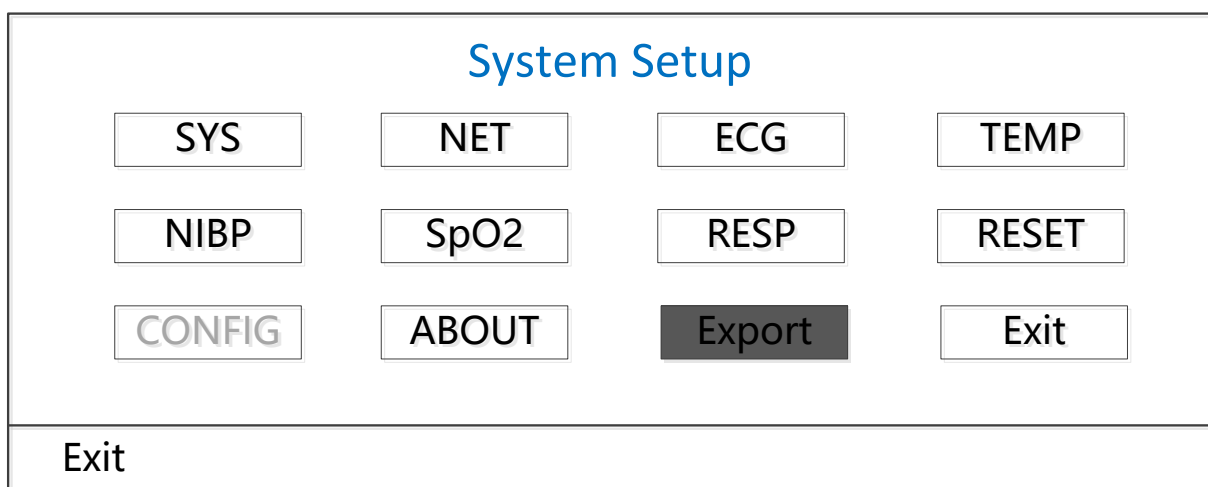



Figure 4.14 System Setup

### 4.6.1 How to Select the System Setup Item

**Step 1:** rotate the knob to move the gray cursor to the corresponding item.

**Step 2:** press the knob to enter the corresponding setting screen: System Setup, NET Setup, ECG Setup, TEMP setup, NIBP Setup, SpO<sub>2</sub> Setup, RESP Setup or resuming Default setting. The following contents will be described each one respectively.

Pressing " " key to return to the Main Screen or "Exit" button to return to the System Menu screen.

**Note:** If you disabled Hi and Lo limit alarm function of parameter monitoring, all the alarms related to its parameter monitoring will be disabled as well.

## 4.7 Display Color Settings

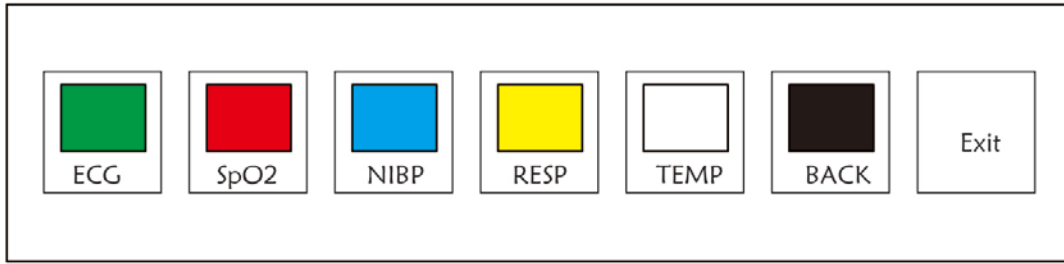



Figure 4.15 Display Color Settings

### 4.7.1 How to Change the Parameter Color

**Step 1:** rotate the knob to move the gray cursor to the setting item and press the knob to confirm your selection.

**Step 2:** rotate the knob to choose the color.

**Step 3:** press the knob again to confirm the chosen color.

Pressing “” key to return to the Main Screen or “Exit” button to return to the System Menu screen.

## 4.8 File Management Screen

ID	<input type="text" value="000001"/>	Name	<input type="text" value="May"/>
Bed	<input type="text"/>	Save	<input type="text" value="OFF"/>
Sex	<input type="text" value="M"/>	Age	<input type="text" value="30"/>
			<input type="text" value="Exit"/>
	0123456789ABCDEFGHIJ IJKLMNOPQRSTUVWXYZ		<input type="text" value="OK"/>

Figure 4.16 Document management screen

### 4.8.1 How to Add a New Patient

The document/archive management screen can be used to manage information about the patient. In the screen, the operator can enter and modify the patient ID, Name, Bed number, Sex, and Age. The operator can also choose to save the patient data in the permanent storage.

**ID:** Or Patient ID. To enter patient ID, choose the patient ID field by using the “Navigation Knob”. Press it to enter the text entry box. Rotate the knob to choose the letter and press the knob to enter the letter. To delete the letter, move the cursor to the letter and rotate the knob to enter spaces (after the H). Use the spaces to replace the letters. After finishing entering the patient ID, choose “Exit” button and press the knob to exit the text entry.

The patient ID is the unique identifier for the patient. When the patient ID changes, the system considers the patient has changed.

**Name:** Enter the patient's name.

**Bed:** Enter the bed number.

**Sex:** Choose between M or F for male and female.

**Age:** Choose the age field and use the "Navigation Knob" to select an age.

**Save:** The operator can choose how much of the data that needs to be saved. The unit is hour. Once the time is chosen, the system starts to save data from the current time. If OFF is selected, it means that the data will not be saved. The system will determine the time range according to the available disk space. If no disk space available, SAVE will be displayed as OFF. When the user intends to save the current ECG waveform permanently, please delete the history files.

**Exit:** Press this key to return to the System Menu screen.

## 4.9 OxyCRG Screen

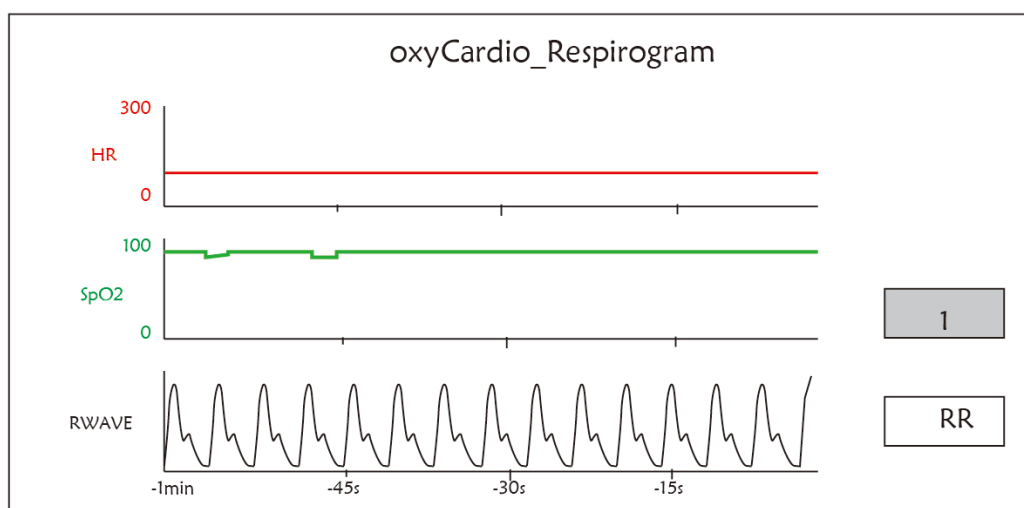

**Figure 4.17 OxyCRG Screen**

This screen displays the value or waveform of HR, SpO<sub>2</sub>, and RESP waveform or Respiration Rate in selected time.

### 4.9.1 Operation Instructions

**Step 1:** rotate the knob to move the gray cursor to the button "1" or "RWave" and press the knob to confirm your selection.

**Step 2:** rotate the knob to choose the setting. The time can be set as 1 minute, 2 minutes or 4 minutes. The third channel waveform display can be set as RWAVE (Respiration waveform) or RR (Respiration Rate).

**Step 3:** press the knob to confirm your setting.

Pressing " " key to return to the Main Screen.

## 4.10 Event List Screen

PID	Date/Time	Event Type	Value	Hi/Lo Limit
000001	03-02 13:57	Over HR limit	60	180/61
000001	03-02 14:57	Over SpO2 limit	100	98/99
000001	03-02 15:07	Over HR limit	60	180/61

Figure 4.18 Event List

### 4.10.1 Screen Description

The Event List displays the time, event type, the value detected and high and low alarm limits. The time shows the time when the event occurred. Up to 5 groups of event data can be displayed on one screen.

### 4.10.2 Operating Instructions

Up to 2000 groups of event data can be memorized. Using the Navigation Knob allows the user to scroll the list up and down to view event data. When rotating the knob anti-clockwise, the list scrolls upward. When rotating knob clockwise, the list scrolls down. Please note that when the groups of data are less than 5, the Navigation Knob can not be used to scroll up or down the listing.

Pressing “” key to return to the Main Screen.

## 4.11 MC Calculator

This monitor supplies 10 kinds of medicine calculation and titration display function.

Medicine	<input type="text" value="DOBUTANMINE"/>	Weight	<input type="text" value="70.00kg"/>	Gross	<input type="text" value="---"/>
Cubage	<input type="text" value="---"/>	MC	<input type="text" value="---"/>	D/m	<input type="text" value="---"/>
D/h	<input type="text" value="---"/>	D/kg/m	<input type="text" value="---"/>	D/kg/h	<input type="text" value="---"/>
TS	<input type="text" value="---"/>	DS	<input type="text" value="---"/>	Drop	<input type="text" value="---"/>
Duration	<input type="text" value="---"/>				

Figure 4.19 Medicine Dosage Calculator Screen

### 4.11.1 Medicine Dosage Calculator



Medicine types which can be perform drug dosage calculation: AMINOPHYLLINE, DOBUTAMINE, DOPAMINE, EPINEPHRINE, HEPARIN, ISUPREL, LIDOCAINE, NIPRIDE, NITROGLYCERIN, and PITOCIN.

**Drug Dosage Calculation adopts the following formula:**

Medicine Consistency (MC) = Medicine Gross / Cubage

(Dose/minute) = (Dose/hour) / 60

(Dose/Kg/m) = (Dose/m) / Weight

(Dose/Kg/h) = (Dose/h) / Weight

Transfusion Speed (TS) = (Dose/h) / MC

Drop Speed = TS / (Cubage/drop)

Duration = Medicine Gross / Dose/h





**Formula Introduction:** Dose/m=Dose per minute; Dose/h=Dose per hour; Dose/Kg/m=Dose per Kg per minute; Dose/Kg/h=Dose per Kg per hour.

On medicine calculation screen, at first the operator should move the gray cursor to "Medicine" to select the calculated medicine name, and then move the cursor to "Weight" to select and confirm patient weight, at this time MC analysis screen is shown as Figure 4.20.

Medicine	DOBUTANMINE	Weight	70.00kg	Gross	500.00kg
Cubage	500.00ml	MC	1.00mg/ml	D/m	1.00mg
D/h	60.00mg	D/kg/m	14.28mcg	D/kg/h	857.14mcg
TS	60.00ml/h	DS	20.00GTT/min	Drop	20.00GTT/ml
Duration	8.33h				

**Figure 4.20 MC Analysis Screen**

Rotate the Navigation knob to move the cursor to the option which needs to be calculated, press the knob and rotate it to obtain calculating value. When the calculating value is selected, the calculated value will be displayed in corresponding position. Each calculating option has limit range, if the result exceeds range, it will display "...".

-  **On MC analysis screen, other menu options can not enter value unless entering patient's weight and medicine name again, in default status it is no effective. The values in system is a group of stochastic initial values, the operator should not consider it as calculating standard, please according to doctor's device enter a group values which are suitable for patient.**
-  **The unit of every medicine is settled unit or unit series. The operator must select the appropriate unit according to doctor's device. In a unit series, unit carry performs automatic adjustment along with the current entering value. When exceeding the range of this unit expression, the system will display "...".**
-  **When the operator finishes one option entering, the system will give visible indication in menu to remind operator to check the correctness of entering value.**
-  **For every new entering value, please perform confirming. The operator should take it seriously, only the entering is correct, the calculating result is believable and reliable.**

**Select Medicine Type:** Move the cursor to “Medicine”, rotate Navigation knob to perform selection. Ten options: AMINOPHYLLINE, DOBUTAMINE, DOPAMINE, EPINEPHRINE, HEPARIN, ISUPREL, LIDOCAINE, NIPRIDE, NITROGLYCERIN, and PITOCIN. The default medicine is AMINOPHYLLINE.

**Weight:** when entering into medicine calculating window, the operator should enter patient's weight; the weight is used for MC calculation only; weight: 0.5Kg to 300Kg selectable; step: 0.5Kg; default: 70 Kg for adult; 20Kg for Pediatric.

- 🔔 **Medicine calculation function just supplies a medicine calculator function. The values in table can have no relation with the monitored patient, so the weight in this menu and the weight in system are two different values. When update a patient in system operation, the value in this menu will not be affected.**

## 4.12 Tourniquet Function

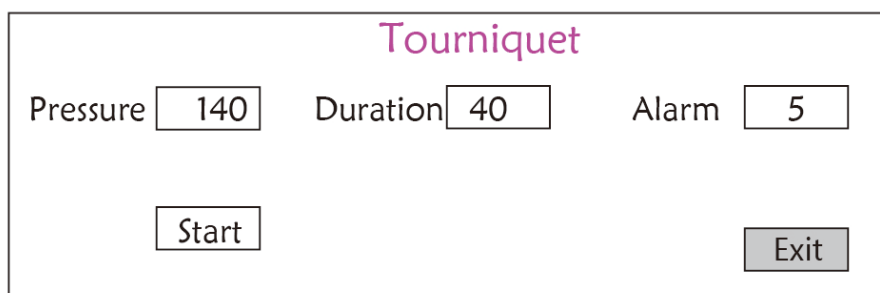

**Figure 4.21 Tourniquet**

- ✧ **“Pressure”**: when you use Tourniquet function, you need to preset a cuff pressure for hemostasia. The pressure is adjustable, and its adjusting limit is different depending on patient type:
  - for neonate**: preset range: 70~100 mmHg, default value: “90” mmHg;
  - for Pediatric**: preset range: 80~130 mmHg, default value: “110” mmHg;
  - for adult**: preset range: 80~180mmHg, default value: “140” mmHg.
  - ☛ If the pressure drops down slowly under 10mmHg compared with the preset value due to little air leakage in the pneumatic system when time passes by, the monitor will re-inflate to maintain the cuff pressure close to the preset pressure value.

**Note**: the unit of cuff pressure is the same as the NIBP unit in NIBP Setup.
- ✧ **“Duration”**: After presetting the cuff pressure, you need to set the time period for maintaining the preset pressure after inflation. “5, 6, 7,...120” minutes adjustable. The default value is “40” minutes.
  - If the set value is “xx” minutes, the monitor will count down from “xx” minutes automatically when starting cuff inflation. When time is up, it will deflate automatically.
- ✧ **“Alarm”**: the alert time is for reminding user that the preset operation of tourniquet is going to end. It can be chosen from 1 to 60 minutes, and the default value is “5” minutes. If the set value is “xx” minutes and when counting down time reaches “xx” minutes, the monitor will give off alarm sound until deflation ends. The alarm type is high priority alarm. (For example: if the duration is 40 minutes and the alert time is 5 minutes, the alarm will ring to prompt when the duration counts down to 5 minutes. The Prompt Info area starts to prompt: TOUR C-D 300 seconds. )
- ✧ **“Start”**: shift cursor to “Start” and press “■” key, “Start” becomes “Stop” and meanwhile the blood cuff starts being inflated; Pressing “Stop” button can stop using this function. After deflation, it will change to “Start” again.

### 4.12.1 Operation Instructions

**Step 1:** rotate the knob to move the gray cursor to the setting item and press the knob to confirm your selection.

**Step 2:** rotate the knob to change the setting or modify the setting value.

**Step 3:** press the knob again to change and repress it to save the setting.

Pressing “” key to return to the Main Screen or “Exit” button to return to the System Menu screen.

## Chapter 5 Parameter Settings

**Step 1:** rotate the knob to move the gray cursor to the setting item and press the knob to confirm your selection.

**Step 2:** rotate the knob to change the setting or modify the setting value.

**Step 3:** press the knob again to change and repress it to save the setting.

Pressing “” key to return to the Main Screen.

Long pressing Navigation Knob to enter into “System Menu” screen.

### 5.1 System Parameter Settings

On “System Menu” screen, select “Setup” → “SYS” to enter into system related settings.

System Setup							
Type	DULT	Mode	Demo	LANG	ENG	FILL	OFF
Frez	ECG	Disp2	NIBP	AlamVol	5	Key	ON
Beep	5	DefView	Main	Pitch	Mode2		Exit

**Figure 5.1 System Setup**

✧ **Type:** The category of patient being monitored, this can be selected from Adult, Pediatric and Neonate.

**Adult:** the patient is adult.

**Pediatric:** the patient is pediatric.

**Neonate:** the patient is neonate.

The default is “Adult”

When changing the patient type, the monitor will change the default alarm settings, and initialize the NIBP and SpO<sub>2</sub> measuring module accordingly. Please pay special attention to the patient type before starting the monitoring. It is forbidden to use Adult type on the Pediatric patient, or it may cause serious injury.

✧ **Mode:** Monitor working mode selection. The “Real Time” shows the normal working mode with real time waveform and data. The “Demo” shows the demo working mode with demo waveform and data. In the demo mode, all the signals and data are generated by the device for demonstrating and testing purpose. The default is “Real Time”

- ✧ **LANG:** The current language used, which can be selected by the user. There is no default for this setting. However, the setting can be saved.
- ✧ **Fill:** When the fill setting is ON, the plethysmogram and respiration waveform will be displayed with filled curves. When it is OFF, the monitor displays the line graph. The default is OFF.
- ✧ **Frze:** Pressed the key to freeze the selected waveforms. The options are "All" and "ECG". When "ECG" is selected, the monitor only freezes the ECG waveform. When "All" is selected, the monitor freezes all the waveforms including ECG, plethysmogram, and respiration waveform. The factory default is "ECG"
- ✧ **Disp2:** The alternative screen display to be viewed. Options: "Obsev" (Remote Observation) "7 ECG" (7 traces of ECG waveforms), "NIBP", "Parameter" and "Trend" can be selected. The factory default is "Observ".
- ✧ **Initial:** when the monitor is powered up, and 3 seconds later, the monitor will shift into default monitoring view (screen) specified by "Initial" automatically. Two options: "Main" and "Disp 2". "Main" means the main screen as default screen, and "Disp 2" means the default display screen will be set as alternative screen "Disp 2" while power up.
- ✧ **Backlight:** to set the brightness of LCD backlight, 3 levels (0, 1 and 2) for optional, the factory default is level 0. Level 0 is darker and level 2 is the brightest. (Note: this function is optional)
- ✧ **AlmVol:** the alarm sound volume. The maximum volume is 7 and minimum is 0, i.e. no sound. When the setting is "0", the icon "🔇" will be displayed on screen to remind user that the alarm sound is off and Alarm Silence function is disabled. The default is 5.
- ✧ **Beep:** If the setting is ON, the press of the button will generate a keystroke sound. The factory is ON.
- ✧ **Pitch(Tone):** to choose the style of pitchtone, the pitchtone means the tone of pulse beep (from ECG or Oximetry) changes when the measured SpO<sub>2</sub> value changes, the higher SpO<sub>2</sub> value, the sharper beep sound (high-pitch). Two options: "Type1" and "Type2". The difference between "Type1" and "Type2" is the tone frequency at the same SpO<sub>2</sub> value. The factory default setting is "Type1".
- ✧ **Key:** to turn on/off the key sound. When the setting is "On", it means the device will give sound out when rotating the Knob or pressing any keys.
- ✧ **Exit:** return to the System Setup screen.

## 5.2 Network Related Settings

On "System Menu" screen, select "Setup" → "NET" to enter into network related settings.

Network Setup				
Local IP	192	168	169	251
Server IP	192	168	169	161
Port	6009	HL7	Recon.	Exit

**Figure 5.2 - Network setup**

- ✧ **Local IP Address:** the local IP address for this device working as a client.
- ✧ **Server IP Address:** the IP address of the remote server (work station) when connecting to a central monitoring system.
- ✧ **Port:** the remote port number to which the monitor will connect to the work station in the central monitoring system. Its setting range is from 6001 to 6064. It can also be used to represent the patient bed number connecting to the work station. For example, the port number 6002 means the monitor is assigned to the bed number 2 in the CSM. The work station can connect to up to 64 bedside monitors, so please set the port number between 6001 and 6064. Press Knob to make the new setting effective.
- ✧ **HL7:** enable the monitor to export data to CIS/HIS by HL7 protocol. The user can select "HL7" or "CEN"(means central monitoring system) for optional.

### 5.3 ECG Related Settings

On "System Menu" screen, select "Setup" → "ECG" to enter into ECG related settings.

ECG Setup			
Lead	<input type="text" value="II"/>	Gain	<input type="text" value="X1"/>
Speed	<input type="text" value="25"/>	HR Hi	<input type="text" value="180"/>
1mV	<input type="text" value="Off"/>	S-T Hi	<input type="text" value="+1.00"/>
Cable	<input type="text" value="0"/>	Filter	<input type="text" value="MON"/>
		Lo	<input type="text" value="40"/>
		Notch	<input type="text" value="50Hz"/>
		Pace	<input type="text" value="Off"/>
		Grid	<input type="text" value="Off"/>
			<input type="button" value="Exit"/>

**Figure 5.3 ECG related settings**

- ✧ **Lead:** Can be chosen among Lead I, II, III, aVR, aVL, aVF, and V (V1-V6). The default is I.
- ✧ **Gain:** The ECG gain, 6 options x1/4, x1/2, x1, x2, x4 and Auto. Auto is for automatic gain control. The factory default is x1
- ✧ **HR Hi:** High limit alarm for heart rate  
**Lo:** Low limit alarm for heart rate  
 The adjustable range and the factory default value can be found in Alarm Section
- ✧ **Speed:** ECG waveform sweeping speed. 4 options: 6.25, 12.5, 25, 50 mm/s. The factory default is 25 mm/s
- ✧ **Mode:** ECG filtering mode. Three options: MON, DIA, and OPE  
**MON:** Monitoring mode. Moderate filtering, it can filter out interference and present good ECG waveforms.  
**DIA:** Diagnosis mode. No filtering, represent the true ECG signal without filtering.  
**OPE:** Operation mode. Deep filtering, it can filter out strong interference.

**The factory default is MON.**

- ✧ **1mV:** Generating the 1mV calibrating signal. This signal is used to test the ECG function of the device. It is not used during normal operation. Factory default is OFF
- ✧ **Notch:** frequency filter. Different hardware configuration may make its options various. One is "ON"/ "OFF" (The factory default is ON.), and it means turn on or turn off the 50Hz frequency filter. The other option is "OFF"/ "50 Hz"/ "60 Hz", please choose "50 Hz" or "60 Hz" frequency filter according to your power supply frequency. The factory default is "50 Hz".
- ✧ **Pace:** Cardiac pacemaker pulse detection. When Pace is "ON", the function of pacemaker pulse detection will be effective. A mark will be displayed on the ECG waveform if the pacemaker generates a pacing pulse when the patient wears a cardiac pacemaker. The factory default is OFF.

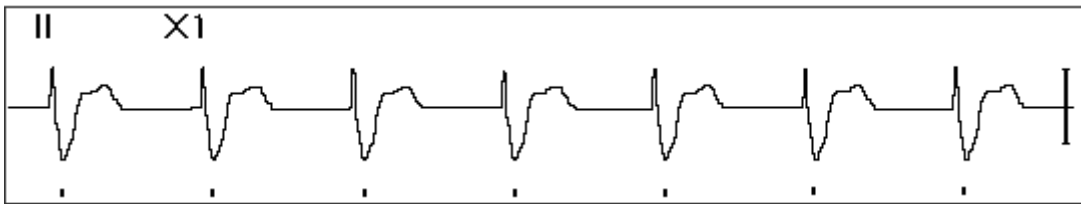

- ✧ **Grid:** The grid on the background for Observing Screen and Frozen & S-T Analysis Screen. Factory default is OFF.
- ✧ **Cable:** Choose the number of lead wires for ECG cable. "3" and "5" for optional.
- ✧ **Exit:** return to the System Setup screen.
  - ▣ **Limits setup:** Move the gray cursor to the High or Low limits of the alarm settings, and press the "Alarm silence" key to turn ON or OFF the alarm for the setting. Yellow color shows ON status, and gray color shows the OFF status.

## 5.4 Temperature Related Settings

On "System Menu" screen, select "Setup" → "TEMP" to enter into temperature related settings.

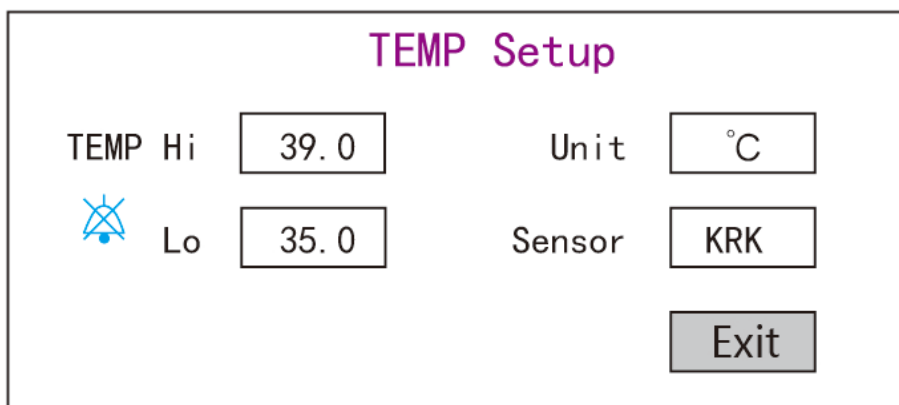

TEMP Setup			
TEMP Hi	39.0	Unit	°C
 Lo	35.0	Sensor	KRK
		Exit	

**Figure 5.4 Temperature related settings**

- ✧ **TEMP Hi:** High alarm limit for temperature

**Lo:** Low alarm limit for temperature

- ✧ **Unit:** the temperature unit, and °C(Celsius) and °F(Fahrenheit) can be selected, the factory default is "°C".
- ✧ **Sensor:** temperature sensor type, "KRK" and "YSI" can be selected. KRK and YSI temperature sensors are different type of thermistors with different R-T characteristic. Please set the sensor type according to the actual used sensor.
- ✧ **Exit:** exit from system settings.

Note: For KRK temperature sensor, its resistance at 25.0°C is 10Kohms, while for YSI temperature sensor, its resistance at 25.0°C is 2.252K ohms.

## 5.5 NIBP Related Settings

On "System Menu" screen, select "Setup" → "NIBP" to enter into NIBP related settings.

### NIBP Setup

SYS Hi <input type="text" value="180"/>	DIA Hi <input type="text" value="120"/>	Mode <input type="text" value="Manu"/>	Cycle <input type="text" value="10"/>
Lo <input type="text" value="60"/>	Lo <input type="text" value="50"/>	Unit <input type="text" value="mmHg"/>	BP verif <input type="text" value="Off"/>
MAP Hi <input type="text" value="160"/>	PR Hi <input type="text" value="180"/>	Leak. Check	
Lo <input type="text" value="50"/>	Lo <input type="text" value="40"/>	Init. P <input type="text" value="150"/>	<input type="button" value="Exit"/>

**Figure 5.5 NIBP related settings**

- ✧ **Unit:** The pressure unit, and mmHg and kPa can be selected. The factory default is mmHg.
- ✧ **Mode:** The measuring mode, manual or automatic. The factory default is manual. The operator needs to press the NIBP button to perform blood pressure measurement. If the Auto mode is chosen, the operator needs to set an cycle interval as well.
- ✧ **Cycle:** The time interval between measurements when the measuring mode is set to Auto. The options are STAT, 1 min, 2 min...480 min. Press NIBP to start measurement and the monitor begins to count down as well. It will take blood pressure measurement automatically after finishing counting down. If "STAT" is selected, press NIBP to take the blood pressure measurement as many times as possible, but it will sustain this state not longer than 5 minutes.
  - 🔔 **WARNING: STAT can only be used for Adult. Using this mode to Pediatric patient can cause serious injury.**
- ✧ **NIBP Cali (BP verification):** It is used to check the accuracy of pressure measuring system within NIBP module, which should be conducted by technicians in test house or service department. There are three options: "Mode 1", "Mode 2" and "OFF" available. After the verification, it is necessary to make sure it is in "OFF" status again, or other operations can't be carried out and NIBP key will be inactivated. Factory default status is "OFF".
- ✧ **Gas Leak:** it is used by technicians to perform a leakage inspection for NIBP pneumatic system.



- ✧ **SYS Hi/Lo:** High and Low alarm limits for systolic pressure
- ✧ **DIA Hi/Lo:** High and Low alarm limits for diastolic pressure
- ✧ **MAP Hi/Lo:** High and Low alarm limits for MAP
- ✧ **PR Hi/Lo:** High and Low alarm limits for PR
- ✧ **Initial inflation pressure setting:** Cuff pressure to be inflated initially, its options are different depending on patient type.

**for neonate:** initial inflation pressure can be: 60, 70, 80mmHg, default setting: 70 mmHg;

**for Pediatric:** initial inflation pressure can be: 80, 100, 120, 140 mmHg, default setting: 100 mmHg;

**for adult:** initial inflation pressure can be: 80, 100, 120, 140, 160, 180, 200mmHg, default setting: 150 mmHg.

- ✧ **Exit:** return to the System Setup screen.

## 5.6 SpO<sub>2</sub> Related Settings

On "System Menu" screen, select "Setup" → "SpO<sub>2</sub>" to enter into SpO<sub>2</sub> related settings.

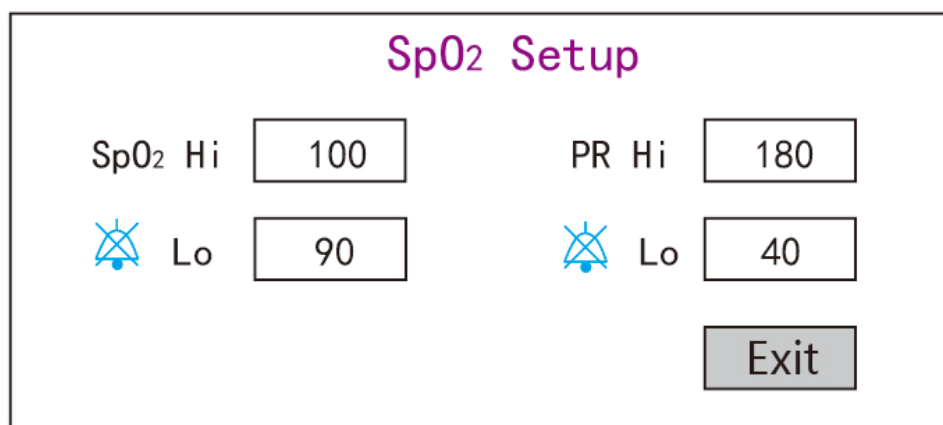

**Figure 5.6 SpO<sub>2</sub> related settings**

- ✧ **SpO<sub>2</sub> Hi/Lo:** High and Low alarm limits for SpO<sub>2</sub>
- ✧ **Pulse Hi/Lo:** High and Low alarm limits for pulse rate.
- ✧ **Response speed:** "Normal", "Steady" and "Fast" for optional. Note: this setting is only for the monitor configured with Envisen SpO<sub>2</sub> Module.
- ✧ **Exit:** return to the System Setup screen.

## 5.7 Respiration Related Settings

On "System Menu" screen, select "Setup" → "RESP" to enter into Respiration related settings.

## RESP Setup

Gain	X2	RR Hi	40	Speed	12.5
Apnea	Off	 Lo	10	Lead	I
<input style="background-color: #cccccc;" type="button" value="Exit"/>					

**Figure 5.7 Respiration related settings**

- ✧ **Gain:** Respiration amplification/gain, 4 options, x1/2, x1, x2, and x4. The default is x2
- ✧ **Speed:** Respiration waveform sweeping speed, 2 options 6.25mm/s and 12.5 mm/s. The default is 12.5 mm/s
- ✧ **Apnea:** timeout setting for apnea alarm. Options: "OFF" and any number from 5 to 120. The step is 1 and its unit is second. When the breathing action is not detected after the time longer than this set period, the trace for respiration waveform will display warning "Apnea xxx second". The default is "OFF".
- ✧ **Type:** Respiration impedance
- ✧ **Lead:** Signal source selection for respiration measurement. 3 options: ECG electrode Lead "I" and "II"
- ✧ **RR Hi:** High limit of respiratory rate alarm
- ✧ **Lo:** Low limit of respiratory rate alarm
- ✧ **Exit:** return to the System Setup screen.

### Restoring to Factory Default Settings

In the System setup screen as shown in Figure 4.14, rotate knob to choose "RESET" and then press the knob, all the value of parameters will resume default setting.

## Chapter 6 Alarms

Alarms, triggered by a vital sign that appears abnormal or by technical problems of the monitor, are indicated to the user by visual and audible alarm indications.

### 6.1 Alarm Categories

By nature, the monitor's alarms can be classified into three categories: physiological alarms, technical alarms and prompt messages.

#### 1. Physiological alarms

Physiological alarms, also called patient status alarms, are triggered by a monitored parameter value that violates set alarm limits or an abnormal patient condition. Physiological alarm messages are displayed in the physiological alarm area.

#### 2. Technical alarms

Technical alarms, also called system status alarms, are triggered by a device malfunction or a patient data distortion due to improper operation or mechanical problems. Technical alarm messages are displayed in the technical alarm area.

#### 3. Prompt messages

As a matter of fact, prompt messages are not alarm messages. Apart from the physiological and technical alarm messages, the monitor will show some messages telling the system status or patient status. Messages of this kind are included in the prompt message category and usually displayed in the prompt information area. Some prompt messages that indicate arrhythmia events are displayed in the physiological alarm area. For some measurements, their related prompt messages are displayed in their respective parameter windows.

### 6.2 Alarm Levels

By severity, the monitor's alarm can be classified into three categories: high level, medium level and low level. In addition, the monitor has preset alarm level about physiological alarm and technical alarm.

Physiological alarm		
Alarm priority level	Alarm Source	Alarm Event
High	ECG	Unable to detect HR, ECG Arrest, ECG Brady, ECG Tachy, VE RUN,SVE RUN, HR is too high, HR is too low, S-T is too high, S-T is too low, VE Run, ECG VPCEST
	SpO <sub>2</sub>	Unable to detect SpO <sub>2</sub> , SpO <sub>2</sub> too high, SpO <sub>2</sub> too low, PR too high, PR too low
	Respiration	Apnea, RR too high, RR too low
	Temperature	Temp1 too high, Temp1 too low, Temp2 too high, Temp2 too low, TD too high
	NIBP	NIBP SYS too high, NIBP SYS too low, NIBP DIA too high, NIBP DIA too low, NIBP MAP too high, NIBP MAP too low, PR too high, PR too low
Medium	ECG	VE RonT, SVE RonT, S-T1 too high, S-T1 too low, S-T2 too high, S-T2 too low, S-T3 too high, S-T3 too low, S-T4 too high, S-T4 too low, S-T5 too high, S-T5 too low, S-T6 too high, S-T6 too low, S-T7 too high, S-T7 too low
Low	ECG	Miss Beat, VE Early, SVE Early, VE Couplet, SVE Couplet, VE Short Run, SVE Short Run, SVE Run, VE Insert, SVE Insert, VE Bigeminy, SVE Bigeminy, VE Trigeminy, SVE Trigeminy, Multiform Beat
Technical alarm		
Alarm priority level	Alarm source	Alarm Events
High	System	Low battery, SpO <sub>2</sub> modular malfunction, Unknown error
Medium	ECG/SpO <sub>2</sub>	Lead(s) off, SpO <sub>2</sub> Probe off, SpO <sub>2</sub> value exceeds measuring range, HR exceeds measuring range
	IBP	IBP1 Probe off, IBP2 Probe off, IBP3 Probe off, IBP4 Probe off
Low	NIBP	Self-test failed, System error, Over time, Signal weak, Cuff error, Air leakage, Pressure error, Out of range, Too much motion, Over pressure, Signal saturation, Detected air leakage, BP exceeds measuring range,
	TEMP	Temperature self-detect failed, TEMP1/TEMP2 exceed(s) measuring range
	CSM	Electrodes off

Related to 3 levels alarm sources, medical and nursing staff should have different response to deal with potential dangerous, the detailed demands as follows:

1. High priority alarm: medical and nursing staff should response immediately.
2. Medium priority alarm: medical and nursing staff should response quickly.
3. Low priority alarm: medical and nursing staff should response as soon as possible.

**NOTE:** Some models may have only Medium and Low alarm priority because of the different configuration.

## 6.3 Alarm Indicators

When an alarm occurs, the monitor will indicate it to the user through visual or audible alarm indications.

### 6.3.1 Alarm lamp

Lamp color	Alarm level	Alarm event
Red flashing	High priority alarm	ECG Brady, ECG Tachy, Low battery, Vital sign alarm
Yellow flashing	Medium priority alarm	Lead off, Probe off, Sensor off, VE RonT,SVE RonT
Yellow	Low priority alarm	Other Arrhythmia event
Green	Normal	

### 6.3.2 Alarm message

When an alarm occurs, an alarm message will appear in the technical or physiological alarm area. And the alarm message is shown in different color to match the alarm level (high priority alarm in red, medium priority alarm in yellow, and low priority alarm in white).

### 6.3.3 Highlighting Numeric

If an alarm triggered by an alarm limit violation occurs, the numeric of the measurement in alarm will be highlighted.

### 6.3.4 Audible Alarm Tones

The alarm tone is distinct from the heart beat tone, keystroke tone and pulse tone in frequency, the alarm tones identify the alarm levels as follows:

- ✧ High priority alarm: beep+beep+double+beep+pause+beep+beep+double+beep
- ✧ Medium priority alarm: triple beep
- ✧ Low priority alarm: single beep

 When multiple alarms of different levels occur simultaneously, the monitor will select the alarm of the highest level and give visual and audible alarm indications accordingly.

### 6.3.5 Alarm Status Symbols:

Apart from the aforementioned alarm indicators, the monitor still uses the following symbols telling the alarm status.

◆ For the customer purchased the monitor with configuration of “**Alarm pause**”, then this area shows the alarm sound status. There are 3 alarm sound status:

①  means the alarm sound is enabled;







②  means the alarm sound is disabled or means the alarm volume is 0 (alarm is mute), at this time the user should pay more attention to the patient;

③ "  01:59 " means the alarm sound is paused. Text display area: when the alarm sound is paused, it displays counting-down time, otherwise, it displays the date. Move the cursor on this text display area can bring up the edit box of "Alarm volume" setting.

### 6.3.6 Changing Alarm Volume

To set the alarm sound volume.

Step 1: Select "System Menu" → "Setup" → "SYS" → "Alarm Volume".

-  When the alarm sound is switched off, the monitor will give no audible alarm tones even if a new alarm occurs. Therefore the user should be very careful about whether to switch off the alarm sound or not.
-  Do not rely exclusively on the audible alarm system for monitoring. Adjustment of alarm volume to a low level may result in a hazard to the patient. Always keep the patient under close surveillance.
-  Pausing or switching off alarms may result in a hazard to the patient, please be very careful.
-  If occurrence of multiple alarm signal at the same time, the monitor will only show the high priority alarm in the form of audible alarm and alarm lamp. Meanwhile, all alarm signals information including message descriptions and numerical highlight etc. will be shown respectively and simultaneously on the screen.
-  It is suggested that the users should not change the alarm volume lower than the factory default setting if close and constant attention could not be paid to the patient, otherwise the negligence of alarm event might cause irreversible harm to the patient.
-  During the alarm silence period, any new alarm event can activate the audible alarm again and the audible alarm function resumes normal state.

## 6.4 Understanding the Alarm Setting

Select "Menu" and select parameter (such ECG, SpO<sub>2</sub>, NIBP, TEMP, etc.). you can review and set alarm limits, alarm switches, high/low alarm limit for each parameter.

1. The volume of audible alarm is adjustable, the other properties of the alarm cannot be adjusted by the user. Such as alarm priority setting, alarm lamp flashing and so on. In addition, all alarms in this patient monitor are "non-latched", that is to say, when the alarm event disappears, the corresponding alarm will automatically stop. The alarm volume range is shown as below:

- ◇ High: 0dB~80dB (The distance between device front and test instrument is 1m)
- ◇ Medium: 0dB~75dB (The distance between device front and test instrument is 1m)
- ◇ Low: 0dB~70dB (The distance between device front and test instrument is 1m)

2. Alarm settings are non-volatile, that means the previous settings will still sustain even the patient monitor is powered off including unexpected power failure and manual reboot.

### 6.4.1 High and Low Alarm Setting Range

Parameter	Setting range	
	High limit	Low limit
HR (bpm)	(Low limit+1)~350	0~(High limit-1)
S-T (mV)	(Low limit+0.01)~2.50	-2.5~(High limit-0.01)
SpO <sub>2</sub> (%)	(Low limit+1)~100	0~(High limit-1)
PR (bpm)	(Low limit+1)~300	0~(High limit-1)
RR (rpm)	(Low limit+1)~150	0~(High limit-1)
TEMP1 (°C)	(Low limit+0.1)~60.0	0~(High limit-0.1)
TEMP2 (°C)	(Low limit+0.1)~60.0	0~(High limit-0.1)
TD (°C)	0.0~5.0	

NIBP (Unit)		Adult	Pediatric	Neonate
mmHg				
SYS	High limit	(Low limit+1) ~280	(Low limit+1) ~200	(Low limit+1) ~135
	Low limit	29~ (High limit-1)	29~ (High limit-1)	29~ (High limit-1)
MAP	High limit	(Low limit+1) ~242	(Low limit+1) ~165	(Low limit+1) ~110
	Low limit	20~ (High limit-1)	20~ (High limit-1)	20~ (High limit-1)
DIA	High limit	(Low limit+1) ~232	(Low limit+1) ~150	(Low limit+1) ~100
	Low limit	10~ (High limit-1)	10~ (High limit-1)	10~ (High limit-1)
NIBP (Unit)		Adult	Pediatric	Neonate
kPa				
SYS	High limit	(Low limit+0.1) ~37.3	(Low limit+0.1) ~26.7	(Low limit+0.1) ~18.0
	Low limit	3.9~ (High limit-0.1)	3.9~ (High limit-1)	3.9~ (High limit-0.1)
MAP	High limit	(Low limit+0.1) ~32.3	(Low limit+0.1) ~22.0	(Low limit+0.1) ~14.7
	Low limit	2.7~ (High limit-0.1)	2.7~ (High limit-0.1)	2.7~ (High limit-0.1)
DIA	High limit	(Low limit+0.1) ~30.1	(Low limit+0.1) ~20.0	(Low limit+0.1) ~13.3
	Low limit	1.3~ (High limit-0.1)	1.3~ (High limit-0.1)	1.3~ (High limit-0.1)

## 6.4.2 Factory Default Alarm Limit Setting Value

Type		Adult	Pediatric	Neonate
Parameter				
HR	High limit	180 bpm	200 bpm	220 bpm
	Low limit	40 bpm	50 bpm	50 bpm
RR	High limit	30 rpm	30 rpm	100 rpm
	Low limit	8 rpm	8 rpm	30 rpm
TEMP	High limit	39 °C	39 °C	39 °C
	Low limit	35 °C	35 °C	35 °C
SYS	High limit	180 mmHg	130 mmHg	110 mmHg
	Low limit	60 mmHg	50 mmHg	50 mmHg
DIA	High limit	120 mmHg	90 mmHg	90 mmHg
	Low limit	50 mmHg	40 mmHg	30 mmHg
MAP	High limit	160 mmHg	110 mmHg	100 mmHg
	Low limit	50 mmHg	40 mmHg	30 mmHg
SpO <sub>2</sub>	High limit	100 %	100 %	100 %
	Low limit	90 %	85 %	85 %
S-T segment	High limit	+1.00mV	+1.00mV	+1.00mV
	Low limit	-1.00mV	-1.00mV	-1.00mV
PR	High limit	180 bpm	200 bpm	220 bpm
	Low limit	40 bpm	50 bpm	50 bpm
TD		2 °C	2 °C	2 °C

## 6.5 Testing Alarms

When the monitor starts up, a self-test is performed. In this case the alarm lamp will light, and the system gives a beep. This indicates that the visible and audible alarm indicators are functioning correctly.

For further testing of individual measurement alarms, perform the measurement on yourself (for example SpO<sub>2</sub>) or enter Demo Mode, or use a simulator. Adjust alarm limits and check that appropriate alarm behavior is observed.

## 6.6 When an Alarm Occurs

When an alarm occurs, observe the following steps and take proper actions:

1. Check the patient's condition.



2. Confirm the alarming parameter or alarm category.
3. Identify the source of the alarm.
4. Take proper action to eliminate the alarm condition.
5. Make sure the alarm condition is corrected.

# Chapter 7 ECG Monitoring





## 7.1 Introduction

The electrocardiogram (ECG) is primarily a tool for evaluating the electrical events within the heart. The ECG signals can be detected by electrodes at the surface of the skin, this device connects ECG signals and represents them on the monitor as waveforms and numerical value such as heart rate. The S-T segment measurement and arrhythmia detection can be done as well by the ECG signals.

The ECG electrodes connect the patient and the lead wires and/or ECG cable, the lead wires and/or cable connect to the monitor. The electrode type selection and the locations of the electrodes are very important to ensure accurate ECG measurement.

## 7.2 Safety Information

- ⚠ This patient monitor can only be equipped with ECG cable and/or lead wires provided by the manufacturer; using those from other suppliers may cause improper performance or poor protection while using defibrillator.
- ⚠ Using the same type of qualified and authorized electrodes which should be within its effective life on the same patient. If any side-effect such as allergic or stimulus skin is found, the measurement should be stopped at once. It is prohibited to apply the electrode to the patient with lesion and body putrescence.
- ⚠ To the patient with pacemaker, normally the heart rate meter does not count the pacemaker pulse due to the function of pacemaker pulse inhibition, but for the pacemaker with overshoot pulse, the inhibition function may not be fully effective. So it is important to observe the ECG waveforms carefully and do NOT rely entirely on the heart rate display and alarm system when monitoring the pacemaker patient.
- ⚠ The improper connection with electro-surgical unit may not only cause burns, but also damage the monitor or arouse deviations of measurement. You can take some steps to avoid this situation, such as do NOT use small ECG electrodes, choosing the position which is far away from the estimated Hertzian waves route, using larger electro-surgical return electrodes and connecting them with the patient properly.
- ⚠ In operation mode, the monitor can be used with electro-surgical unit. The monitor's operator should ensure the safety of the patients if in use with electro-surgical unit in accordance with the instructions of this manual. After the elimination of high frequency signal and high frequency electromagnetic field, the monitor can be set to the previous operation mode within 10 seconds without losing any stored data.
- ⚠ Do not use the monitor with electro-surgical unit in non-operation mode, nor with large-scale electrical equipment such as ultrasonic, radiation and magnetic resonance imaging, which may cause electromagnetic interference to the monitor or harm the monitor's operator.
- 🔔 Conductive parts of electrodes, lead wires and cable are forbidden to contact any other conductive parts (including ground).
- 🔔 This patient monitor can resist against the discharge of defibrillator and the interference from the electro-surgical unit. Readings may be inaccurate for a short time after or during using defibrillator or electro-surgical unit.

-  Transient caused by cable circuitry blocks while monitoring may cause artifact on ECG signals yielding wrong heart rate reading and even triggering false alarm. If the electrodes and cable are located in proper places according to this manual's instructions for using electrodes, the chance of this transient occurrence will be decreased.
-  ECG cable and/or lead wires may be damaged while using defibrillator. If the cable and/or lead wires are used again, please do the functional check firstly.
-  When the monitor is inoperable due to overload of ECG signal or saturation of any part of the amplifier, it will prompt "Lead(s) off" to remind the operator.
-  The user should ensure that no predictable hazard will be caused by the summation of leakage currents when several items of monitor are interconnected.
-  When plugging or unplugging the ECG cable, be sure to hold the head of the connector and pull it out.

## 7.3 Preparing to Monitor ECG

### 7.3.1 Preparing the Patient and Device

#### 1. Skin preparation

The quality of ECG waveform displayed on the monitor is a direct result of the quality of the electrical signal received at the electrode. Proper skin preparation is necessary for good signal quality at the electrode. A good signal at the electrode provides the monitor with valid information for processing the ECG data. To ensure enough electrolyte material on the skin of patients, you need to moisten the measuring sites with 70% isopropyl Ethanol. This will usually be sufficient for ECG monitoring for a short time (30 to 60 minutes).

2. Connect the cable to the connector marked with the "ECG" icon on the signal input panel.

3. Place the electrode to the patient according to **Section 7.3.2**.

4. Attach the ECG lead wires to the electrode

5. Make sure the monitor is turned on and is ready for monitoring.

6. After starting the monitor, if the electrodes become loose or disconnected during monitoring, the system will display "LEAD OFF" on the screen to alarm the operator.

- ✧ It might not display ECG waveform when using ECG cable with 3 lead wires while the setting of "Cable" is set as "5" in the ECG parameter setup menu. Only single channel of ECG signal can be obtained while using 3 lead wires and the "Cable" is set as "3", this ECG signal can be selected between Lead I, Lead II and Lead III.
- ✧ In order to obtain other Leads of the ECG signals, such as aVL, aVR, aVF and V, the ECG cable with 5 lead wires should be used and the "Cable" should be set to "5". At this situation, 7 Leads of ECG signal (lead I, II, III, aVL, aVR, aVF, V) can be obtained and displayed simultaneously.

**Note:** If any side-effect such as allergic or itchy reaction is found, remove the electrodes from the patients immediately.



The symbol indicates that the cable and accessories are designed as the "CF" type level for protection against electric shocks and with defibrillation-proof capability.

### 7.3.2 ECG Electrodes Placement

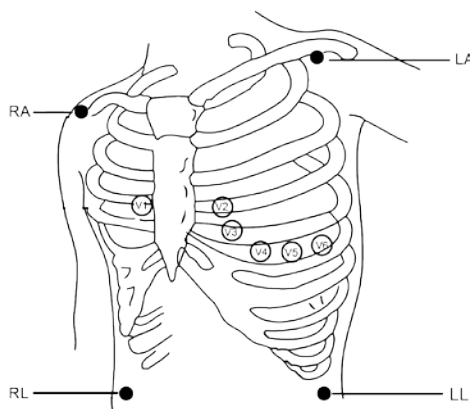

**Electrode Placement**

The ECG leads and their corresponding locations are as follows:

Electrode connection 1 (IEC Standard)		Electrode connection 2 (AHA Standard)		Electrode position on body surface
Color code	Label on lead wire connection	Color code	Label on lead wire connection	
Red	R	White	RA	Right Arm: The intersection between the centerline of the right clavicle and Rib 2
Yellow	L	Black	LA	Left Arm: The intersection between the centerline of the left clavicle and Rib 2
Green	F	Red	LL	Left Leg: Left part of the upper abdomen
Black	N/RF	Green	RL	Right Leg: Right part of the upper abdomen
White	C	Brown	V	Any of the following location (C1-C6 or V1-V6) on chest
White/red	C1	Brown	V1	4 <sup>th</sup> Intercostal (IC) space at right border of sternum
White/yellow	C2	Brown/yellow	V2	4 <sup>th</sup> IC space at left border of sternum

White/green	C3	Brown/green	V3	Midway between V2 and V4
White/brown (blue)	C4	Brown/blue	V4	5 <sup>th</sup> IC space on left midclavicular line
White/black	C5	Brown/red	V5	Left anterior axillary line at the horizontal level of V4
White/purple	C6	Brown/purple	V6	Left midaxillary line at the horizontal level of V4

## 7.4 Understanding the ECG Display

Your display may be configured to look slightly different.

### ECG waveform

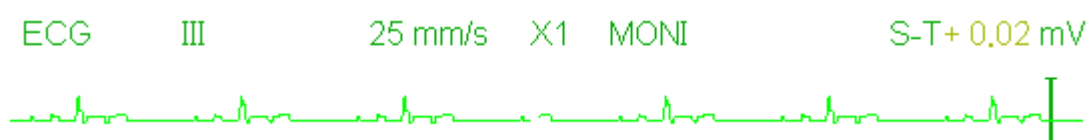

- ✧ "ECG": parameter label.
- ✧ "III": ECG lead. III means ECG lead III.
- ✧ "25mm/s": ECG waveform sweeping speed, unit is "mm/s".
- ✧ "X1": ECG waveform gain. "X1" means the waveform scale with base gain. Refer to Section 3.1 for details.
- ✧ "MONI": ECG filtering mode. There are three types: diagnose, monitoring and operation. Refer to Section 3.1 for details.
- ✧ "S-T+0.02mV": S-T segment value, here indicates the value is 0.02mV.

### Heart Rate Panel:

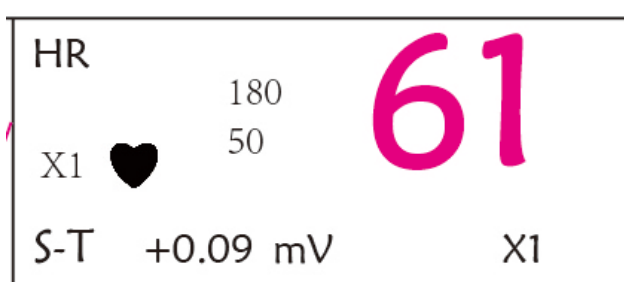

Figure 4.5 Heart Rate Panel

- ✧ "HR": heart rate. The 61 on the right is the heart rate measured.
- ✧ "bpm": the unit of heart rate, it means "beats per minute".

- ✧ "❤️": the heart-beat symbol, blinks corresponding to the R wave of ECG waveform. The flashing speed is the same with the heart rate
- ✧ "180/50": high and low alarm limit setting for heart rate.
- ✧ "ST+0.09mv": the measured mili-volts value for S-T segment level.
- ✧ "X1": ECG waveform gain (amplification), available options are:
  - "Auto" Automatic waveform scale.
  - "x1/4" 1/4 scale size of the base gain.
  - "x1/2" Half scale size of the base gain.
  - "x1" Waveform scale with the base gain.
  - "x2" Twice scale size of the base gain.
  - "x4" Four times scale size of the base gain

## 7.5 Changing ECG Settings

See Section 5.3 for details.

## 7.6 About Arrhythmia Detection and Template Learning

- ✧ **ARR:** ECG arrhythmia analysis

**ARR switch:** the switch of ECG arrhythmia detection. The default is OFF.

**Extra ARR Learning:** indication of ARR learning status or activating ARR learning manually.

When ARR is set to "ON", the device will start to learn the regular ECG signal automatically for ARR detection and icon "ARR" will be displayed. The device will finish the learning after a certain period, and the icon will become

"ARR". The detected arrhythmia waveform will be displayed on the third or the last ECG waveform display channel; If there is only one ECG waveform display channel, then the detected arrhythmia waveform will be re-displayed and frozen on this channel for 8 seconds. The arrhythmia waveform will be re-displayed on the cascaded waveform channel if there is a single Lead of ECG signal displayed with cascaded waveform channels.

Note: Because Arrhythmia detection needs a template ECG waveform as reference which is a piece of normal ECG waveform with regular rhythm and stable amplitude, it is necessary to re-activate the template learning when the patient is changed, or the Arrhythmia detection is incorrect. For better using the Arrhythmia detection, it is recommended to wait for a clean and stable ECG waveform before starting ARR detection during the monitoring.

Note: when the device is restarted, the Arrhythmia detection is reset to its default status.

- ☞ During Arrhythmia detection, incorrect detection might occur if the non-ECG waveforms (e.g. square or triangle waveform) appear.
- ☞ Before starting the 1mV calibration signal, please turn off the Arrhythmia detection.
- ☞ During Arrhythmia detection, the template learning is very important. The device requires a group of stable QRS complex waveforms to build up this template. If the system detects Arrhythmia incorrectly, please re-activate the template learning and obtain the correct template.

- 🔔 The arrhythmia analysis program is intended to detect ventricular arrhythmias. It is not designed to detect atrial or supraventricular arrhythmias. It may incorrectly identify the presence or absence of an arrhythmia. Therefore, a physician must analyze the arrhythmia information with other clinical findings.
- 🔔 Take care to initiate template relearning only during periods of normal rhythm and when the ECG signal is relatively noise-free. If template learning takes place during ventricular rhythm, the ectopics may be incorrectly learned as the normal QRS complex. This may result in missed detection of subsequent events of V-Tach and V-Fib.

### 7.6.1 Understand the ARR Type

Type	Abbreviation	Full name
1	ECG TACHY	Tachycardia
2	ECG BRADY	Bradycardia
3	ECG ARREST	Cardiac Arrest
4	MISS BEAT	Missing Beat
5	VE EARLY	Ventricular Premature Contraction (VPC)
6	SVE EARLY	Supra-ventricular Premature Contraction (SVPC)
7	VE COUPLET	Ventricular Couplet
8	SVE COUPLET	Supra-ventricular Couplet
9	VE RUN	Ventricular Run
10	SVE RUN	Supra-ventricular Run
11	VE SHORT RUN	Ventricular Short Run
12	SVE SHORT RUN	Supra-ventricular Short Run
13	VE BIGEMINY	Ventricular Bigeminy
14	SVE BIGEMINY	Supra-ventricular Bigeminy

15	VE TRIGEMINY	Ventricular Trigeminy
16	SVE TRIGEMINY	Supra-ventricular Trigeminy
17	VE INSERT	Ventricular Insert
18	SVE INSERT	Supra-ventricular Insert
19	VE RONT	Ventricular RonT
20	SVE RONT	Supra-ventricular RonT

## 7.7 About S-T Segment Monitoring

✧ **Alarm:** to turn on or off over-limits alarms of HR and S-T, and set their high and low alarm limits. Setting range See Section **Alarms**

□ **HR:**

High: High limit for heart rate alarm.

Low: lower limit for heart rate alarm.

□ **S-T:** the switch of S-T over-limits alarm, the default is unselect, that's, turn off the over-limits alarm. If you want to turn on the over-limits alarm, the password is required.

**High:** High limit for S-T alarm.

**Low:** Low limit for S-T alarm.

### Manual S-T segment measurement operation:

The operator can use the Navigation Knob to do the S-T segment measurement manually, the value is displayed with "S-T +0.xxx mV". There are 2 cross cursors on screen. The red cross is the activated one. The arrows ( $\leftarrow$  and  $\rightarrow$ ) on the red cross indicate the directions that the cross cursor moves when rotating the Navigation Knob. Press the Navigation Knob can change directions of the cross cursor or change the activating status of the cross cursor.

The measured S-T value will be accurate only in "Diagnosis" mode, while the S-T value is less meaningful in other modes. In "Diagnosis" mode, when ARR event is detected, the S-T value is only for reference.

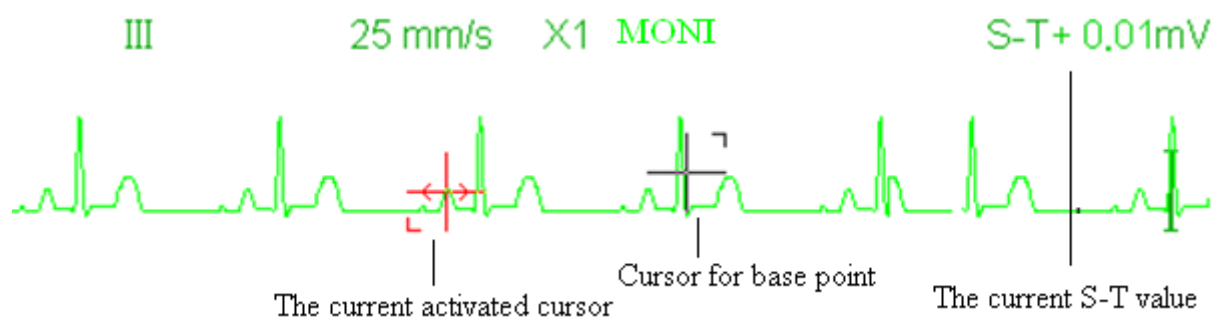

⚠ The S-T segment measuring algorithm has been tested for accuracy of the ST segment data. The significance of the ST segment changes need to be determined by a clinician.



## 7.8 Freezing Waveform

When there are waveforms displayed on screen, press the Freeze key to enter into waveform freezing screen. During freezing, the frozen symbol "❄" and frozen time will be displayed on the upper right corner of the waveform area. At the moment, the operator can do S-T measurement, and get the real-time value of S-T segment

There are 2 Freeze types: "ECG waves", "EEG" (if optioned) and "All waves", which can be set in System Settings window.

## 7.9 Factors Affecting ECG signal

- ❖ Interference from Electro-surgical Unit;
- ❖ Doesn't set the filter mode properly;
- ❖ Poor grounding;
- ❖ Electrodes are not placed properly;
- ❖ Use expired electrode or use disposable electrode repeatedly;
- ❖ The skin placed electrode is unclean or poor contact caused by scurf and hair;

## Chapter 8 Monitoring Respiration (RESP)

### 8.1 Introduction

Respiration is monitored by measuring the impedance across the thorax via electrodes placed on chest. When the patient is breathing or ventilated, the volume of air changes in the lungs, resulting in impedance changes between the electrodes. The device applies safe high-frequency current through ECG electrodes into body and measures the change of voltage between the electrodes to reflect the thoracic impedance while ECG monitoring is not affected. Respiration rate (RR) is calculated from these impedance changes, and the respiration waveform is displayed on the monitor screen.

### 8.2 Safety Information

- When monitoring the patient's respiration, it is recommended to use the so-called "non-OR" ECG cable which has no built-in resistors to prevent the energy loss of defibrillator discharge. Otherwise the performance of respiration monitoring is degraded.
- The respiration measurement does not recognize the cause of apneas. It only indicates an alarm if no breath is detected when a preset time has elapsed since the last detected breath. Therefore, it cannot be used for diagnostic purpose.
- If operating under conditions according to the EMC Standard EN 60601-1-2 (Radiated Immunity 3V/m), field strengths above 1V/m may cause erroneous measurements at various frequencies. Therefore it is recommended to avoid the use of electrically radiating equipment in close proximity to the respiration measurement unit.

### 8.3 Understanding the RESP Display

RESP waveform:



Respiration Panel:



- ✧ "RR": the label of Respiration. "rpm" is the unit of the Respiration Rate (respiration per minute). The big font "16" is the value of Respiration rate.

✧ "🫁": Breath symbol. The blinking frequency is the same as the Respiration Rate.

## 8.4 Changing RESP Settings

See Section 5.7 for details.

## Chapter 9 Monitoring NIBP

### 9.1 Introduction

#### 9.1.1 The Oscillometric Blood Pressure Measurement









This device applies the typical non-invasive blood pressure measurement with the oscillometric method. A cuff is used to occlude the artery by inflating it above the patient's systolic pressure, the device measures the amplitude of pressure changes with pulsation in the cuff as the cuff pressure decreases. The pulsations increase in amplitude, and reach a maximum, then diminish along with the decrement of cuff pressure. The cuff pressure corresponding to the maximal pulse amplitude approximates to the mean artery pressure (MAP), the cuff pressure at the pulse amplitude backward reduced according to proper proportion is defined as systolic pressure (SYS), and the cuff pressure at the pulse amplitude forward reduced according to proper proportion is defined as diastolic pressure (DIA)

#### 9.1.2 The Oscilometric method vs. the Korotkoff Sound Method

Blood pressure measurements by the oscillometric method and Korotkoff sound method have good correlation with the invasive blood pressure measurement. Notwithstanding, any of the non-invasive blood pressure measurements has its one-sidedness when it is compared to the invasive measurement. Studies show that, the oscillometric method has its advantages over the Korotkoff sound method in less error, higher reliability and stability especially in critical cases such as arrhythmia, vasoconstriction, hypertension, shock, etc.

### 9.2 Safety Information

- When taking the blood pressure measurement on a neonate patient, do NOT operate in the Adult mode. The high inflation pressure may cause lesion or even body putrescence. Even though the monitor can identify the cuff type so it will stop inflation and indicate "Cuff error" when taking the blood pressure measurement for a neonate in the "Adult" patient type setting. The user (doctor or nurse) should pay more attention to select the correct patient type.
- It is recommended to take the blood pressure measurement manually
- NIBP monitoring is prohibited to those who have severe hemorrhagic tendency or with sickle cell disease, otherwise, partial bleeding will appear.
- Do NOT wrap the cuff on limbs with transfusion tube or intubations or skin lesion area, otherwise, injury may be caused to the limbs.
- If the patient is moving or suffering tremble, hyperkinesia or arrhythmia, it may cause the inflation time of inflatable balloon endures longer, which may not only prolong the measurement time, but also result in the body wrapped by the cuff is troubled by purpura, hypoxemia and neuralgia because of the friction.
- Before the measurement is carried out, select an appropriate measuring mode depending on the patient type (adult, pediatric or neonate).
- The air-hose which connects the cuff and monitor should be straightway without any tangle.

-  When an adult patient is monitored, the device may fail in giving the blood pressure measurement if the pediatric patient type is selected.
-  Prior to use of the cuff, empty the cuff until there is no residual air inside it to ensure accurate measurement.
-  Do NOT twist the air tube or put heavy things on it.
-  When unplugging the air tube, hold the head of the connector and pull it out.
-  The NIBP measurement will not be affected when the monitor is connected to the patient on whom the electro-surgical unit and defibrillator is being used.
-  The appearance of arrhythmia results in irregular heart beat which may affect the accuracy of NIBP measurement. It is recommended to take the measurement again at this situation.
-  The blood pressure measurements determined with this device are equivalent to those obtained by a trained observer using the cuff/stethoscope auscultatory method, within the limits prescribed by the American National Standard, manual, electronic, or automated sphygmomanometers.
-  The monitor can be used on the patient who are pregnant or pre-eclamptic, but close attention should be paid to such patients.
-  The performance of NIBP function can be affected by the extremes of temperature, humidity and altitude, please use it within the appropriate working environment.

### 9.3 Measurement Limitations

1. Serious angiospasm, vasoconstriction, or too weak pulse.
2. When extremely low or high heart rate or serious arrhythmia of the patient occurs. Especially auricular fibrillation will lead to unreliable or impossible measurement.
3. Do not take the measurement when the patient is connected with an artificial heart-lung machine.
4. Do not take the measurement when the patient uses diuresis or vasodilator.
5. When the patient is suffering from major hemorrhage, hypovolemic shock and other conditions with rapid blood pressure change or when the patient has too low body temperature, the reading will not be reliable, for reduced peripheral blood flow will lead to reduced arterial pulsation.
6. Patient with hyperadiposis;

### 9.4 Measurement Mode

There are three measuring mode for NIBP measurement:

- ✧ **Manual:** measurement on demand.
- ✧ **Auto:** continually repeated measurements at set intervals.
- ✧ **STAT:** continually rapid series of measurements over a five minute period, then return to the previous mode.

## 9.5 Setting Up the NIBP Measurement

### 9.5.1 Preparing to Measure NIBP

1. Power on the monitor.
2. Check the patient information area on the screen. Set a correct patient type, select a correct cuff size.
3. Connect the tube with cuff to the connector marked with "NIBP" icon on the signal input panel.
4. Select a cuff with correct size, then unfold the cuff and wrap it around the patient's upper arm as follows:
  - ✧ Determine the patient's limb circumference.
  - ✧ Select an appropriate cuff by referring to the limb circumference marked on the cuff. The width of the cuff should be 40% of the limb circumference, or 2/3 of the upper arm's length. The inflatable part of the cuff should be long enough to encircle at least 50% to 80% of the limb. When putting on the cuff, unfold and wrap it around the upper arm evenly to appropriate tightness.
  - ✧ Remember to empty the residual air in the cuff before the measurement is commenced.
  - ✧ Locate the cuff in such a way that the artery mark "↓" is at a location where the clearest pulsation of brachial artery is observed.
  - ✧ The cuff should be tightened to a degree where insertion of one finger is allowed.
  - ✧ The lower end of the cuff should be 2cm above the elbow joint.

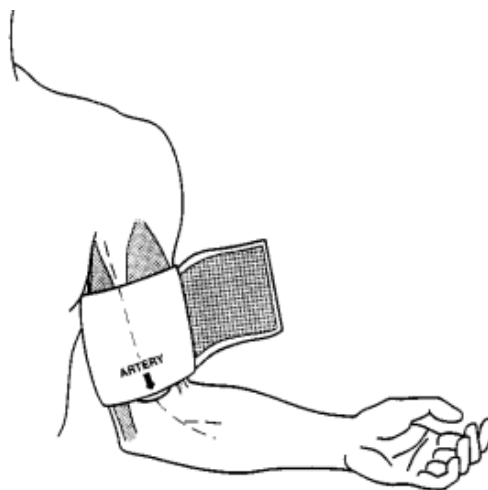

### 9.5.2 Starting and Stopping Measurements

Starting and Stopping NIBP Measurements by pressing NIBP measure key "".

- Too frequent blood pressure measurements may cause purpura, ischemia and neuropathy in the limb with the cuff. Inspect the application site regularly to ensure skin quality and inspect the extremity of the cuffed limb for normal color, warmth and sensitivity. If any abnormality occurs, move the cuff to another site or stop the

blood pressure measurements immediately.

### 9.5.3 Factors Affecting NIBP Measurement

Like common non-invasive blood pressure measurement, improper operation may cause inaccurate or blank result or misunderstanding of the measuring information when the oscillometric method is used to take the blood pressure measurement. These points need particular attention of the operators.

#### 1. Requirements of the cuff:

- 1) Appropriate cuff should be selected according to the age of the patient.
- 2) Remember to empty the residual air in the cuff before the measurement is commenced.
- 3) Locate the cuff in such a way that the artery mark “” is at a location where the clearest pulsation of brachial artery is observed.
- 4) The cuff should be tightened to a degree where insertion of one finger is allowed.
- 5) The lower end of the cuff should be 2cm above the elbow joint.

2. The patient should lie on the back so that the cuff and the heart are in a horizontal position and the most accurate measurement is taken. Other postures may lead to inaccurate measurement.

3. Do not speak or move before or during the measurement. Care should be taken so that the cuff will not be hit or touched by other objects. The air tube which connects the cuff and monitor should be straightway without any tangle.

4. The measurement should be taken at appropriate intervals. Continuous measurement at too short intervals may lead to pressed arm, reduced blood flow and lower blood pressure, and resulting inaccurate measurement of blood pressure. It is recommended the measurement be taken at intervals of more than two minutes.

5. With the oscillometric method, when blood pressure is measured, the inflation pressure of the cuff will be automatically adjusted according to the previous measurement. Generally, the initial inflation pressure is 150mmHg (for the adult mode) or 120mmHg (for pediatric) or 70 mmHg (for neonate) when it is powered on. Following that, 28mmHg (for adult) or 25mmHg (for pediatric) or 25mmHg (for the neonate) will be added on the basis of the last measurement of systolic pressure. In this way, when the blood pressure rises or the patient is changed, the device may fail in giving the result after the first-time inflation. This device will automatically adjust the inflation pressure until the measurement is taken, after that, up to four times retry will be allowed.

6. When an adult patient is monitored, the device may fail in giving the blood pressure measurement if the Pediatric or neonate patient type is selected.

7. When taking NIBP measurement on pediatric or neonatal patients, the operator must select correct patient type depending on different patients (refer to NIBP menu setup) and do NOT operate with the adult patient type setting. The high inflation pressure for adult is not suitable for pediatric patients.

## 9.6 Understanding the NIBP Numerics

### NIBP Panel:

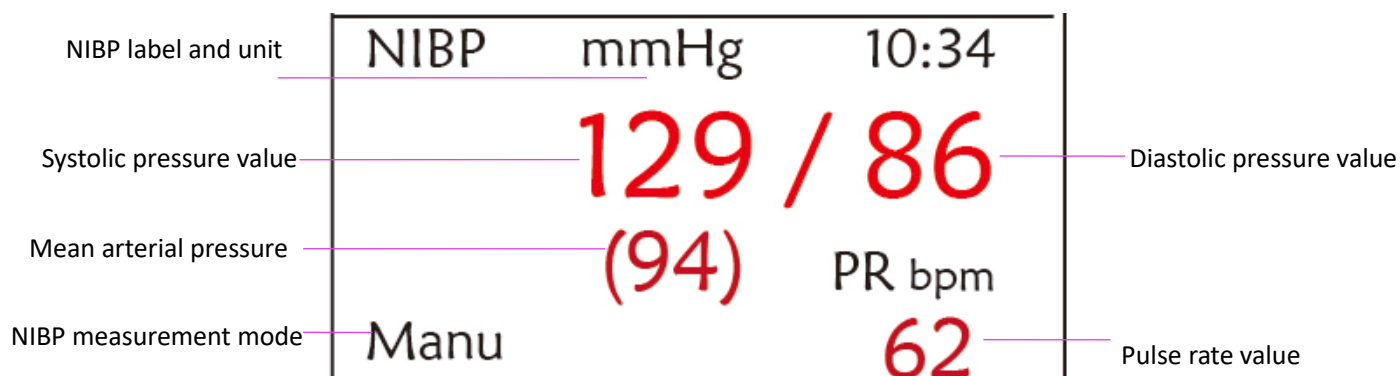

- ✧ **"NIBP"**: the label of blood pressure. "129" is the systolic pressure value, "86" is the diastolic pressure value, and "94" is the mean arterial pressure.
- ✧ **"mmHg"**: the unit of blood pressure value,  $1\text{kPa} = 7.5\text{mmHg}$ .
- ✧ **"PR62"**: pulse rate value when taking blood pressure measurement.
- ✧ **"Manu"**: the icon of NIBP measurement mode. There are 3 modes: "Manual", "Auto" and "STAT". When in "AUTO" mode, a count-down timer is displayed as well.

## 9.7 Changing NIBP Settings

See section 5.5 for details.



# Chapter 10 Monitoring Oxygen Saturation (SpO<sub>2</sub>)

## 10.1 Introduction

The functional oxygen saturation (SpO<sub>2</sub>) - a percentage of the hemoglobin that can transport oxygen, is monitored by this device via a non-invasive optical technique. Based on the principle that oxygenated hemoglobin (HbO<sub>2</sub>) and deoxygenated hemoglobin (Hb) have different absorption character in the spectrum range from red to infrared light, the device measures the amount of oxygenated hemoglobin and pulse rate by measuring the absorption of selected wavelengths of light. The light generated in the probe passes through the tissue and is converted into electrical signals by the photo-detector in the probe. The SpO<sub>2</sub> module processes the electrical signals and gives out waveform data and digital values for SpO<sub>2</sub> and pulse rate displayed on the screen.

## 10.2 Safety Information

- Continuous use of fingertip SpO<sub>2</sub> sensor may result in discomfort or pain, especially for those patients with microcirculatory problem. It is recommended that the sensor should NOT be applied to the same site for over two hours, please inspect the monitoring site every 1~2 hours for skin integrity, and change the measuring site periodically if necessary.
- Check SpO<sub>2</sub> probe application site periodically (every 30 minutes) to determine circulation, positioning and skin sensitivity.
- SpO<sub>2</sub> measuring site must be examined more carefully for some special patient. Do NOT place the SpO<sub>2</sub> sensor on the finger with edema or fragile tissue.
- Avoid placing the SpO<sub>2</sub> sensor on the same extremity with an arterial catheter, blood pressure cuff, or intravascular infusion line, otherwise the blood flow could be interrupted by the cuff or the circulatory condition could make low blood perfusion so that would result in no pulse found or loss of pulse during SpO<sub>2</sub> monitoring and further cause false alarm.
- The SpO<sub>2</sub> measurement of this monitor may not work effectively for all kinds of patients, for whose with weak pulse due to shock, low ambient/body temperature, major bleeding, or use of vascular contracting drug, the measurement will be more sensitive to interference, if stable readings cannot be obtained at any time, discontinue use of SpO<sub>2</sub> monitoring function.
- For those with a substantial amount of staining dilution drug (such as methylene blue, indigo green and acid indigo blue), or carbon monoxide hemoglobin (COHb), or methionine (Me+Hb) or thiosalicylic hemoglobin, and some with icterus problem, the SpO<sub>2</sub> determination by this monitor may be inaccurate.
- The drugs such as dopamine, procaine, prilocaine, lidocaine and butacaine may also be a major factor blamed for serious error of SpO<sub>2</sub> measurements.
- Excessive ambient light may affect the measuring result, it includes fluorescent lamp, dual ruby light, infrared heater, and direct sunlight etc.
- As the SpO<sub>2</sub> value serves as a reference value for judgment of anemic anoxia and toxic anoxia, the measurement result of some patients with serious anemia may also present as good SpO<sub>2</sub> value.

- Do not apply tape to secure the sensor in place or to tape it shut; venous pulsation may lead to inaccurate oxygen saturation measurements.
- Vigorous movement of the patient, strong ambient light, or extreme electro-surgical interference may also affect the SpO<sub>2</sub> measuring accuracy.
- DO NOT stare at the light of SpO<sub>2</sub> sensor (infrared is invisible) when switch it on, for the infrared may do harm to the eye.
- The information, such as the range of the peak wavelengths and maximum optical output power of the light by the SpO<sub>2</sub> sensor can be especially useful to clinicians.
- Always observe the plethysmogram (waveform), which is auto-scaled (normalized). When the measured signal is inadequate, the waveform will be not smooth or irregular, the SpO<sub>2</sub> reading may be unlikely true or displayed with "--", and even a technical alarm will be generated. If in doubt, rely on your clinical judgement, rather than the monitor readout.
- Please do not use the SpO<sub>2</sub> sensor and the monitor when doing the MRI imaging, or burn may be caused by faradism.
- 🔔 For disposal SpO<sub>2</sub> sensor, If the sterile packaging is damaged, do not use it any more.
- 🔔 Check the SpO<sub>2</sub> sensor and cable before use. Do NOT use the damaged SpO<sub>2</sub> sensor.
- 🔔 Before each use, surface-clean sensor and cable with a soft gauze pad by saturating it with a solution such as 70% isopropyl Ethanol. If low-level disinfection is required, use a 1:10 bleach solution.
- 🔔 When the temperature of SpO<sub>2</sub> sensor is abnormal, do not use it any more.
- 🔔 Please do not allow the cable to be twisted or bent.
- 🔔 Please do not use nail polisher or other cosmetic product on the nail.
- 🔔 The fingernail should be of normal length.
- 🔔 The SpO<sub>2</sub> sensor cannot be immersed into water, liquor or cleanser completely, because the sensor has no capability to resist the harmful ingress liquid.
- 🔔 Do not disinfect any SpO<sub>2</sub> sensor by irradiation, steaming, or ethylene oxide.
- 🔔 Carefully route cables to reduce the possibility of patient entanglement or strangulation.
- 📄 The clinical study for SpO<sub>2</sub> measurement accuracy was done on human subjects according to Standard ISO 80601-2-61.
- 📄 A functional tester or SpO<sub>2</sub> simulator can not be used to assess the accuracy of the oximeter or a SpO<sub>2</sub> sensor. However, it can be used to check how accurately a particular oximeter is reproducing the given calibration curve. Before testing the oximeter by a functional tester, please firstly ask the manufacturer which calibration curve is used, if necessary, request the manufacturer for its dedicated calibration curve and download it into the tester.

### 10.3 Apply the Sensor

1. Select an appropriate sensor and probe according to the module type and patient category..
2. Apply the sensor to the proper site of the patient.
3. Select an appropriate adapter cable according to the connector type and plug this cable into the SpO<sub>2</sub> connector.
4. Connect the sensor cable to the adapter cable.

## 10.4 Using Probe and Sensor

When selecting a SpO<sub>2</sub> probe or sensor, do consider the patient's category, adequacy of perfusion, availability of probe site and anticipated monitoring duration. Use only SpO<sub>2</sub> probes provided by our company with this monitor.

**We provide several probes for optional, please refer to the following description according to the probe/sensor you've purchased.**

### Type 1: Adult SpO<sub>2</sub> Finger Clip Sensor

Insert one finger (index finger is preferred, but middle or ring finger with proper nail length is possible as well) into the probe according to the finger mark on the probe, shown as below.

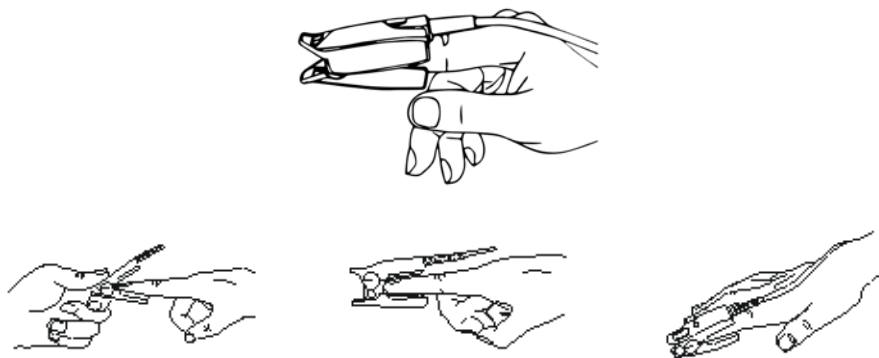

### Type 2: Pediatric SpO<sub>2</sub> Finger Clip Sensor

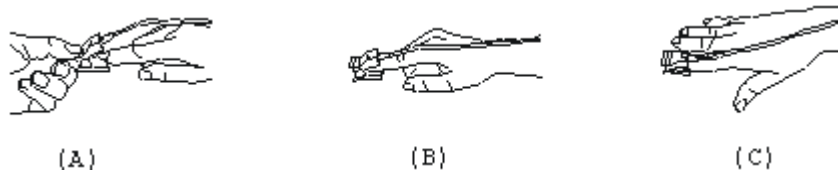

✧ With the upper and lower jaws open, place a finger evenly on the base of the clip. Push the finger tip against the stop so that it is over the sensor window.

(B) Spread open the rear tabs of the sensor to provide even force over the length of the pads.

(C) The sensor should be oriented in such a way that the cable is positioned along the top of the hand.

### Type 3: Adult/Pediatric SpO<sub>2</sub> Finger Rubber Sensor

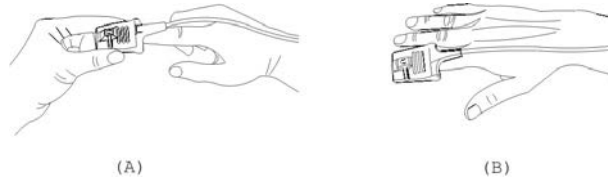

- (A) Hold the sensor with its opening towards the patient's finger, the sensor should be oriented in such a way that the sensor side with a finger tip sign is positioned on the top.
- (B) Insert the patient's finger into the sensor until the fingernail tip rests against the stop at the end of the sensor. Adjust the finger to be placed evenly on the middle base of the sensor. Direct the cable along the top of the patient's hand. Apply adhesive tape to secure the cable if necessary.

**Type 4: Y-type Adjustable Neonate SpO<sub>2</sub> Sensor**

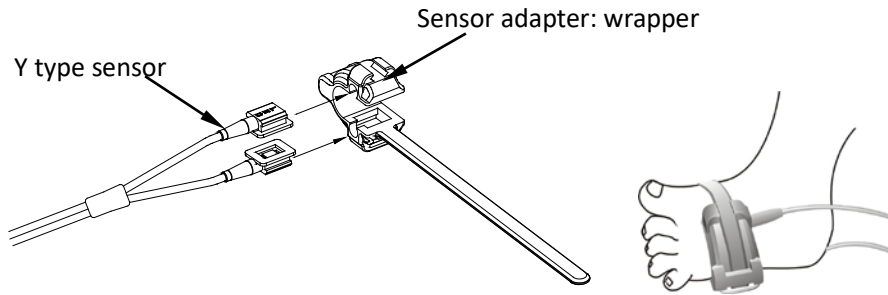

**Type 5: Y type Neonate SpO<sub>2</sub> sensor**

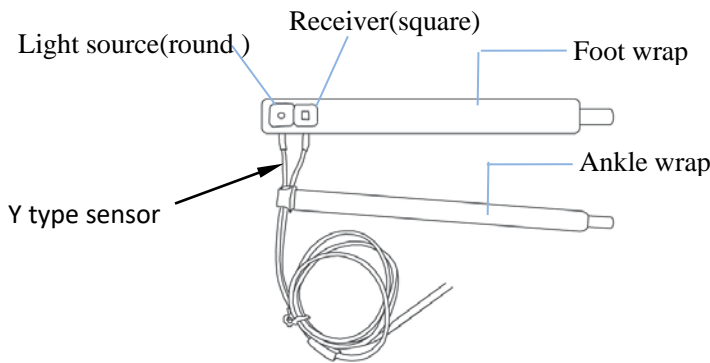

① For proper placement on foot, place the sensors on the outside of the foot behind the pinky toe. Make sure the sensor touch the skin closely, then secure the foot wrap with Velcro. Do not over-tighten.

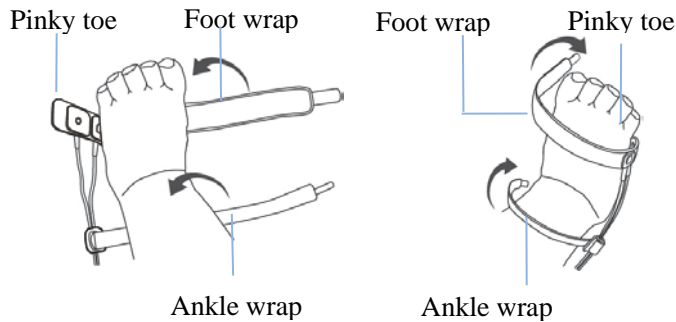

Left foot (wrap goes under the foot)

Right foot(wrap goes from top of the foot)

② Use the ankle wrap to secure the sensor cable on the ankle or leg. Do not over-tighten.

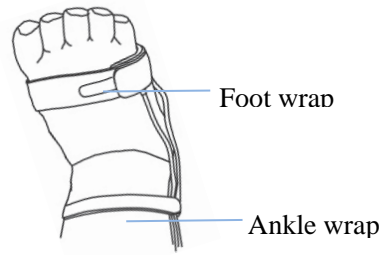

## 10.5 Understanding the SpO<sub>2</sub> and PR Display

### Plethysmogram:

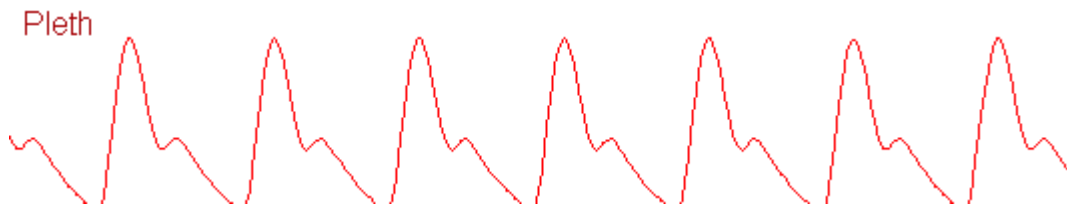

✧ "Pleth": label for abbreviation of plethysmogram.

### SpO<sub>2</sub> Panel:

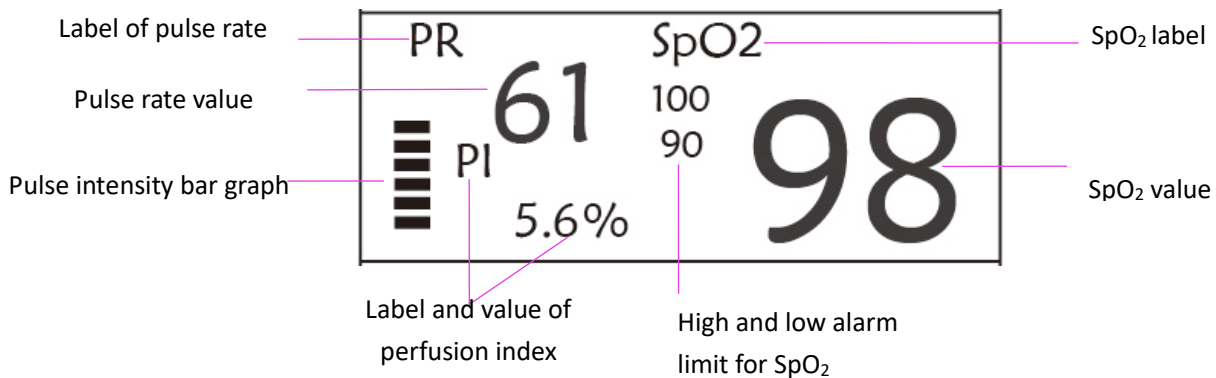

✧ "SpO<sub>2</sub>": SpO<sub>2</sub> label. "98" is the current SpO<sub>2</sub> value.

✧ "PR": the label of Pulse Rate. "61" is the current Pulse Rate value.

✧ "PI%": the label of Perfusion Index, "5.6" is the Perfusion Index.

✧ "PR": Label of pulse rate.

✧ "100/90": the high and low alarm limit setting for SpO<sub>2</sub>.

✧ : pulse intensity bar graph.

## 10.6 Changing SpO<sub>2</sub> and PR Settings

See Section 5.6 for details.

# Chapter 11 Monitoring Temperature

## 11.1 Introduction

The body temperature is monitored by direct measuring mode with the temperature sensor of thermistor type. Very small amount of constant current is applied to the temperature sensor to avoid self-heating, the voltage across the thermistor is measured, and further converted to the temperature reading according to the temperature-resistance characteristic for a specific type of thermistor. The temperature measuring circuit does the self-testing periodically to prevent false reading when there is failure in hardware.

You can simultaneously monitor two temperature sites using the device, for specific model, only one channel temperature is available.

## 11.2 Safety Information

- Verify that the probe detecting function works correctly before monitoring. Unplug the temperature probe cable from the T1 or T2 connector, and the monitor can display the message [T1 Sensor Off] or [T2 Sensor Off] and give alarm tones correctly.
- Make correct choice in setup menu for “KRK” and “YSI” series of temperature sensor used, since they have different temperature-resistance characteristic (KRK thermistor has 10.000K ohms @25°C, YSI thermistor has 2.252K ohms @25°C). Mismatching will cause wrong temperature reading or even out of range.

## 11.3 Making a TEMP Measurement

Please follow the corresponding methods to make temperature measurement according to the temperature transducer you selected.

### ◆ Connecting the thermal temperature sensor:

The temperature sensor is thermo-resistor type it needs time to respond the temperature change, so the accurate temperature value displays after a while. The temperature sensor equipped may have different shape for measuring body surface temperature or cavity temperature respectively.

Normal value for body surface: 36.5°C ~37°C;

Notes:

- For body surface temperature probe, attach the TEMP sensor to the patient, generally if the TEMP sensor and skin doesn't contact closely, the measured value becomes lower, so for those who have requirement for temperature monitoring, add a proper pad to the sensor and fix it with adhesive tape to make them contact firmly.
- Especially for pediatric patient, they have more activities, pay more attention to the sensor fixing.
- The TEMP sensor is designed for use with the specific patient monitor, which cannot be used as applied part to other products.
- The operator is responsible for checking the compatibility of the patient monitor and sensor type including cable before use.

- Incompatible components can result in degraded performance.

◆ **Operation Procedures for thermal temperature transducer:**

1. Securely attach the transducer to the patient;
2. Connect the cable to TEMP probe connector marked "TEMP" in the panel.
3. Check that the menu setting is matching the used temperature sensor type.
4. Check that the alarm settings are appropriate for this patient.

Note: When unplugging the probe, be sure to hold the head of the connector and pull it out.

## 11.4 Understanding the TEMP Display

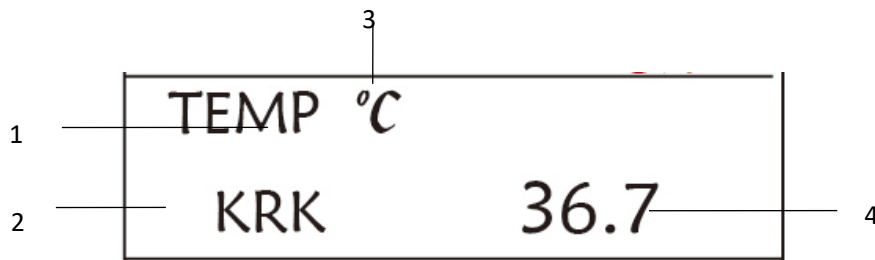

- ✧ **TEMP:** Temperature label. The value below "36.7" is the temperature value.
- ✧ **°C:** Body temperature unit. °C is Celsius, and °F is Fahrenheit.
- ✧ **KRK:** Temperature sensor type. Details see Temperature related setting in Section 5.4.

## 11.5 Changing TEMP Settings

See Section 5.4 for details.

## Chapter 12 Screen Display for Remote Observation

### 12.1 Default Remote Screen

Press the DISP key to shift screen to Observing Screen when setting Disp2 as "Obsev" in System Setup screen, as shown in Figure 13.1.

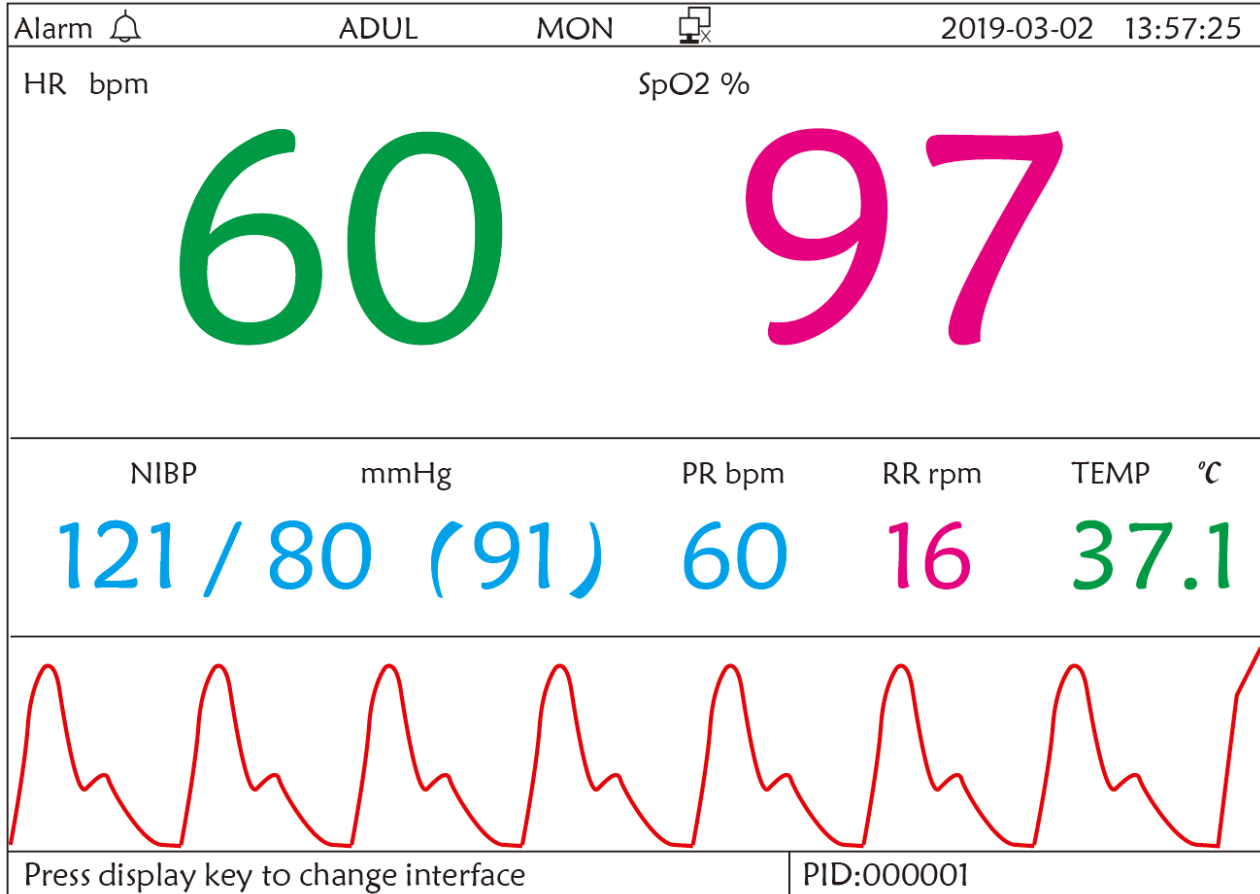







Figure 12.1 Screen display for remote observation

#### Operation Instructions:

-  **ECG lead:** press it to shift the ECG monitoring circulatory among I , II , and III , aVR, aVL, aVF and V.
-  **Alarm silence:** press it to enable or disable the alarm silence function.
-  **Freeze:** press it to freeze the ECG waveform and perform manual S-T segment analysis. Double press this key within 2 seconds to lock or unlock the operation of all other buttons (except power switch) on the front panel.
-  **NIBP:** press it to start or stop NIBP measure.
-  **DISP:** press it to shift the display to the Main Screen.



**Navigation Knob:** No action. When pressing the “Freeze” key, this key is used for S-T segment analysis.

## 12.2 NIBP Screen Display

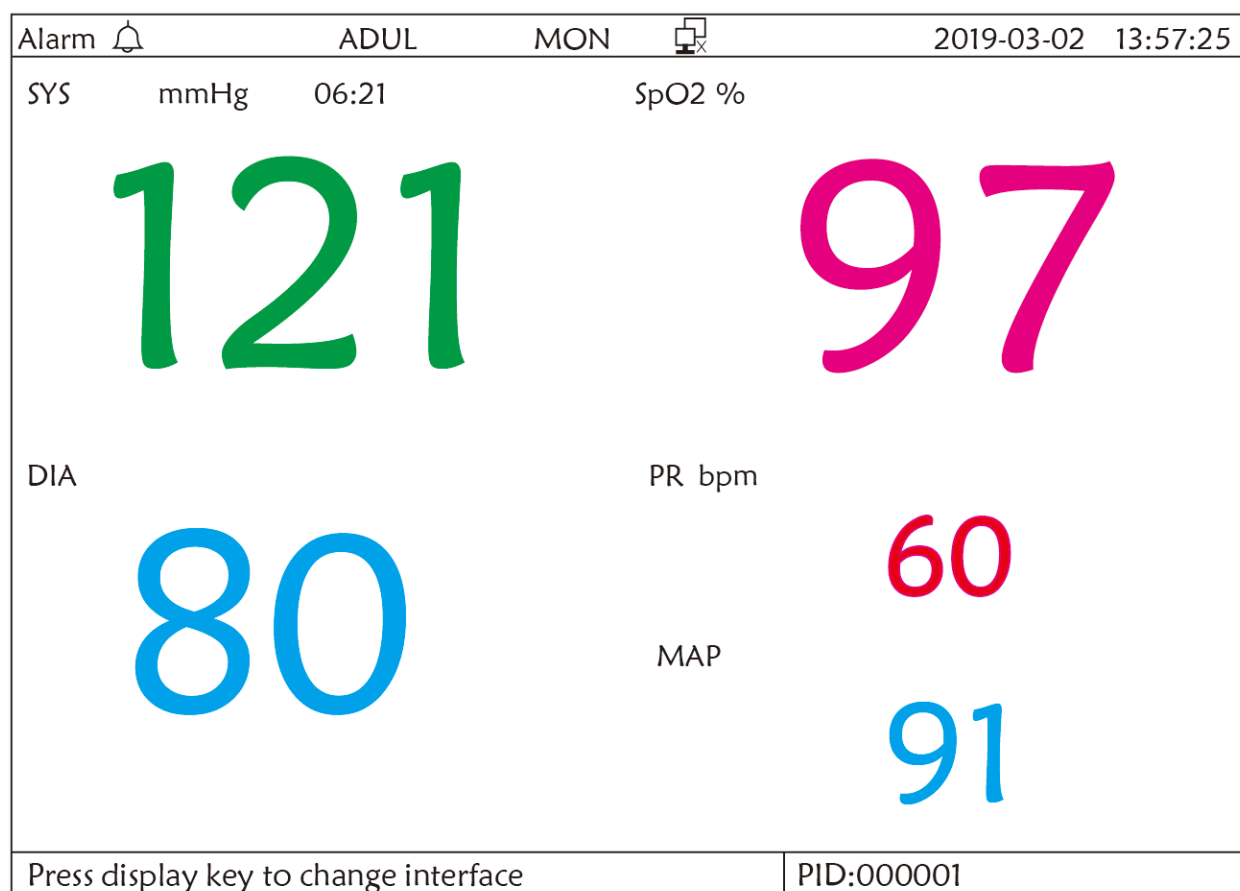

**Figure 12.2 NIBP Screen display**

Press the DISP key to shift the Main Screen to NIBP screen , as shown in Figure, when setting Disp 2 as “NIBP” in “system menu→system setup→Disp2”. In NIBP screen, PR from SpO2 is shown prior to PR from NIBP.

### Operation Instructions:



**EGG lead:** No action.



**Alarm silence:** Press it to enable/disable alarm silence.



**Freeze:** No action.



**NIBP:** Press it to start NIBP measurement, and press it again to cancel measuring NIBP.



**Shift:** Press it to shift the display to the Main Screen.

**Navigation knob:** No action.

## 12.3 Screen Display with ECG Waveforms only

Press the DISP key to shift screen to 7 ECG Waveform Screen when setting Disp2 as "7 ECG" in System Setup screen. In this screen, the operator can view 7 traces of ECG waveforms simultaneously for lead I, II, III, AVR, AVL, AVF and V, as shown in Figure 2.9.

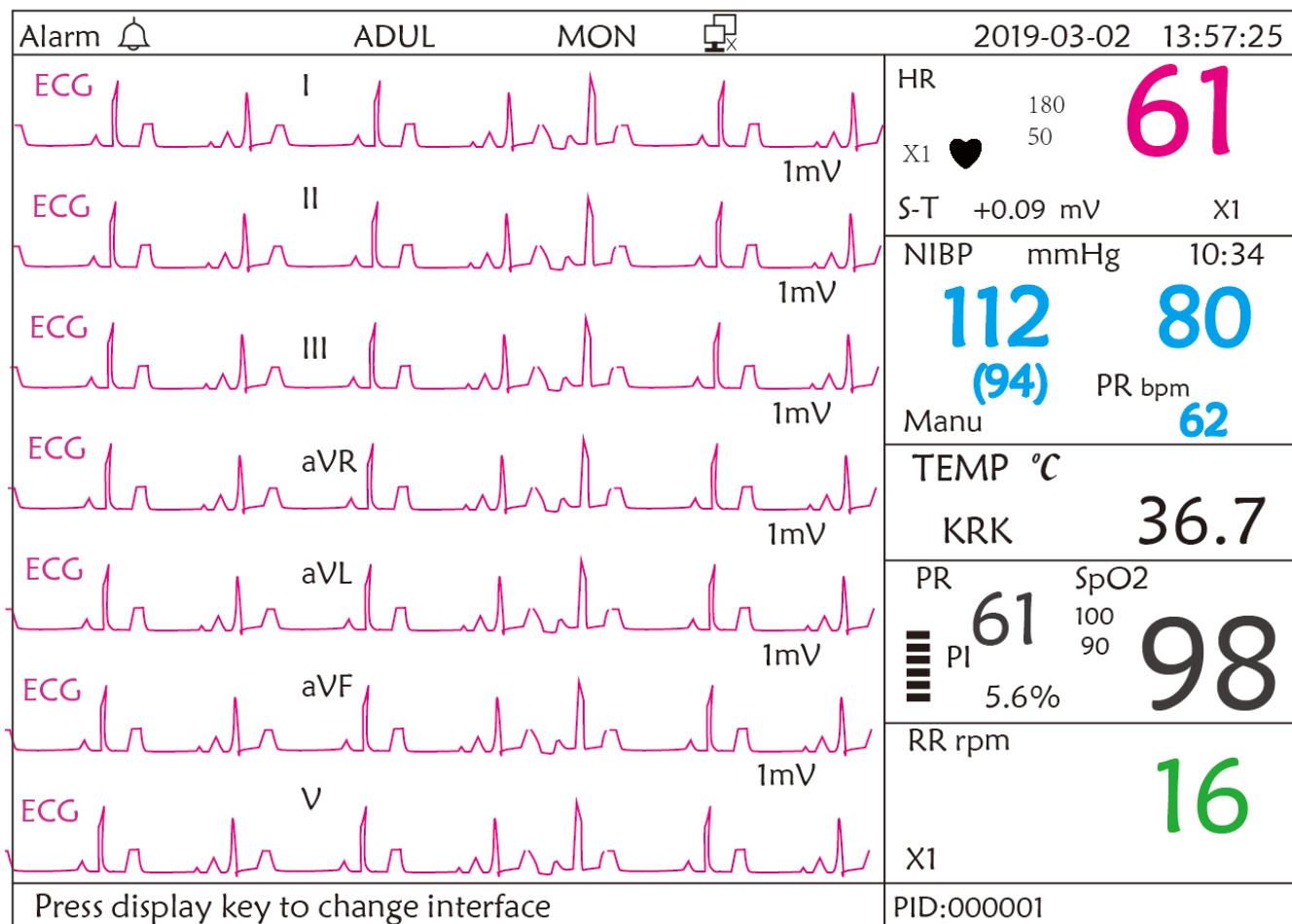







Figure 12.3 7 traces of the ECG waveforms display only

### Operation Instructions:

-  **ECG lead:** No action.
-  **Alarm silence:** press it to enable or disable the alarm silence function.
-  **Freeze:** press it to freeze all 7 ECG waveforms. Double press this key within 2 seconds to lock or unlock the operation of all other buttons (except power switch) on the front panel.
-  **NIBP:** press it to start or stop NIBP measure.
-  **DISP:** press it to shift the display to the Main Screen.

**Navigation Knob:** rotate the knob to adjust the gain for all 7 trace of ECG waveforms. The ECG gain includes 6 options: "Auto", "X1/4", "X1/2", "X1", "X2", "X4".

Notes:

1. For the monitor without ECG function, the display view of 7 traces of ECG waveforms will not be available.
2. When "3" lead wires are chosen in "Cable" setting of ECG Setup, the display view of 7 traces of ECG waveforms will not be available.
3. When "3" lead wires are chosen in "Cable" setting of ECG Setup, the screen changes to the below figure:

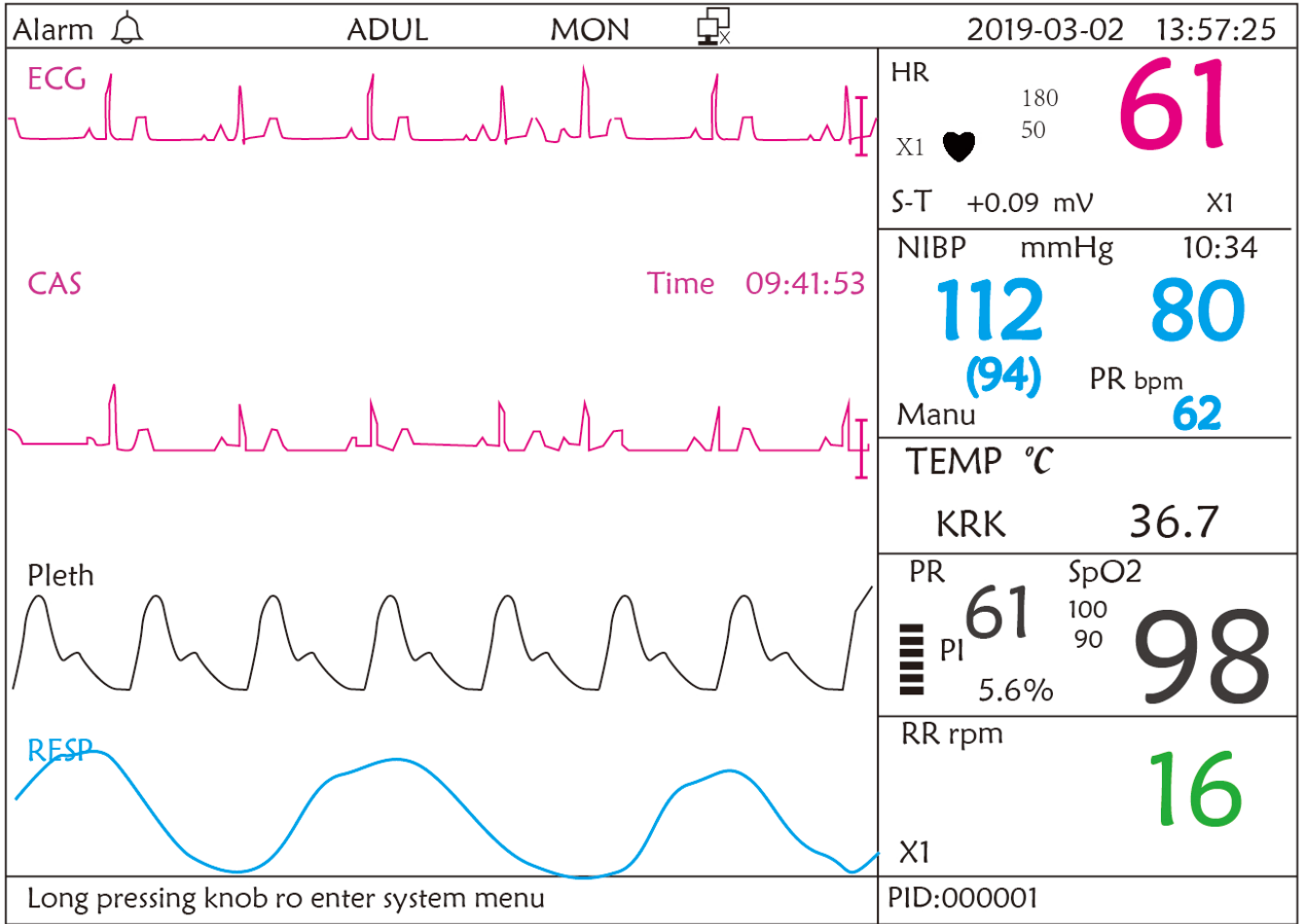

## 12.4 Five Channels Real-time Waveforms and Trends on the Same Screen

Note: this display view is not available for the monitor without ECG function.

When the Disp2 option is "Trend" on System Menu screen, press the DISP key on the Main Screen, the system will enter the trend screen, as shown in Figure 12.4. Five channel real-time waveforms and trend graph can be viewed on this screen.

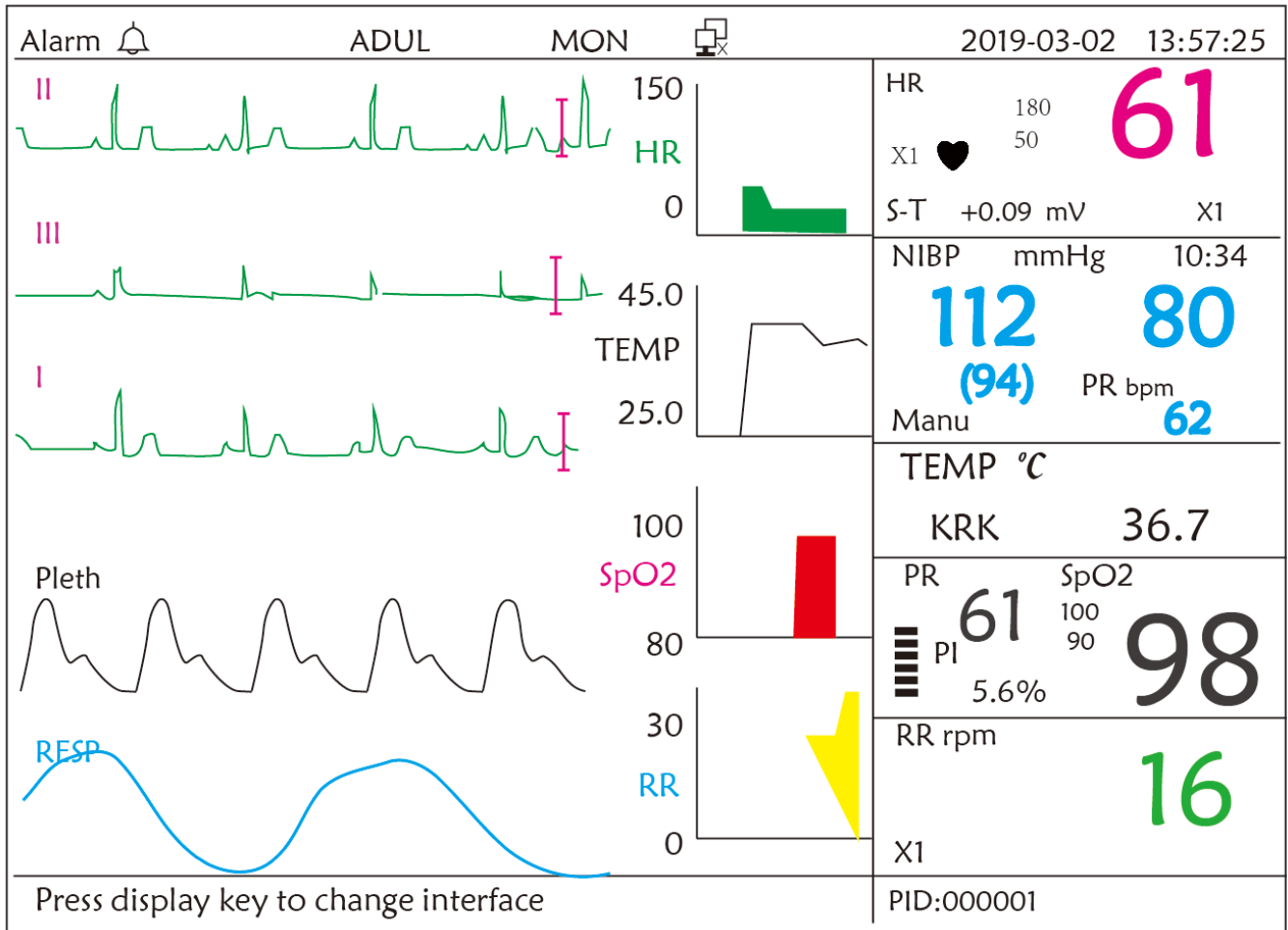

**Figure 12.4 Five Channel Real-time Waveforms and Two Hours Trends**

On this screen, the first channel waveform is ECG waveform of Lead II; the second one is ECG waveform of Lead III; the third one is ECG waveform of Lead I; the fourth one is SpO<sub>2</sub> waveform; the last channel is respiration waveform. On the right of waveform area, from the top down, respectively is heart rate, temperature, SpO<sub>2</sub>, RR trend graph, the abscissa of trend graph (-2h-0) means various trend of every parameter value from now on to two hours before, waveform in trend graph shifts from right to left.

### Operation Instructions:



**ECG lead:** press it to shift the ECG monitoring circulatory among I, II, III, aVR, aVL, aVF and V.



**Alarm silence:** press to enable or disable the alarm silence function.



**Freeze:** press it to freeze ECG waveform or the waveforms of ECG, SpO<sub>2</sub> and RESP according to the

system setting. Double press this key within 2 seconds to lock or unlock the operation of all other buttons (except power switch) on the front panel.



**NIBP:** press it to start or stop NIBP measure.



**DISP:** press it to shift the display to the Main Screen.

**Navigation Knob:** no action.

Note: when "3" lead wires are chosen in "Cable" setting of ECG Setup, then the display view of 2 hours trends screen will not be available.

## 12.5 Parameter Screen

Press the DISP key to shift screen to Parameter Screen when setting Disp2 as "Parameter" in System Setup screen, as shown in Figure12.5

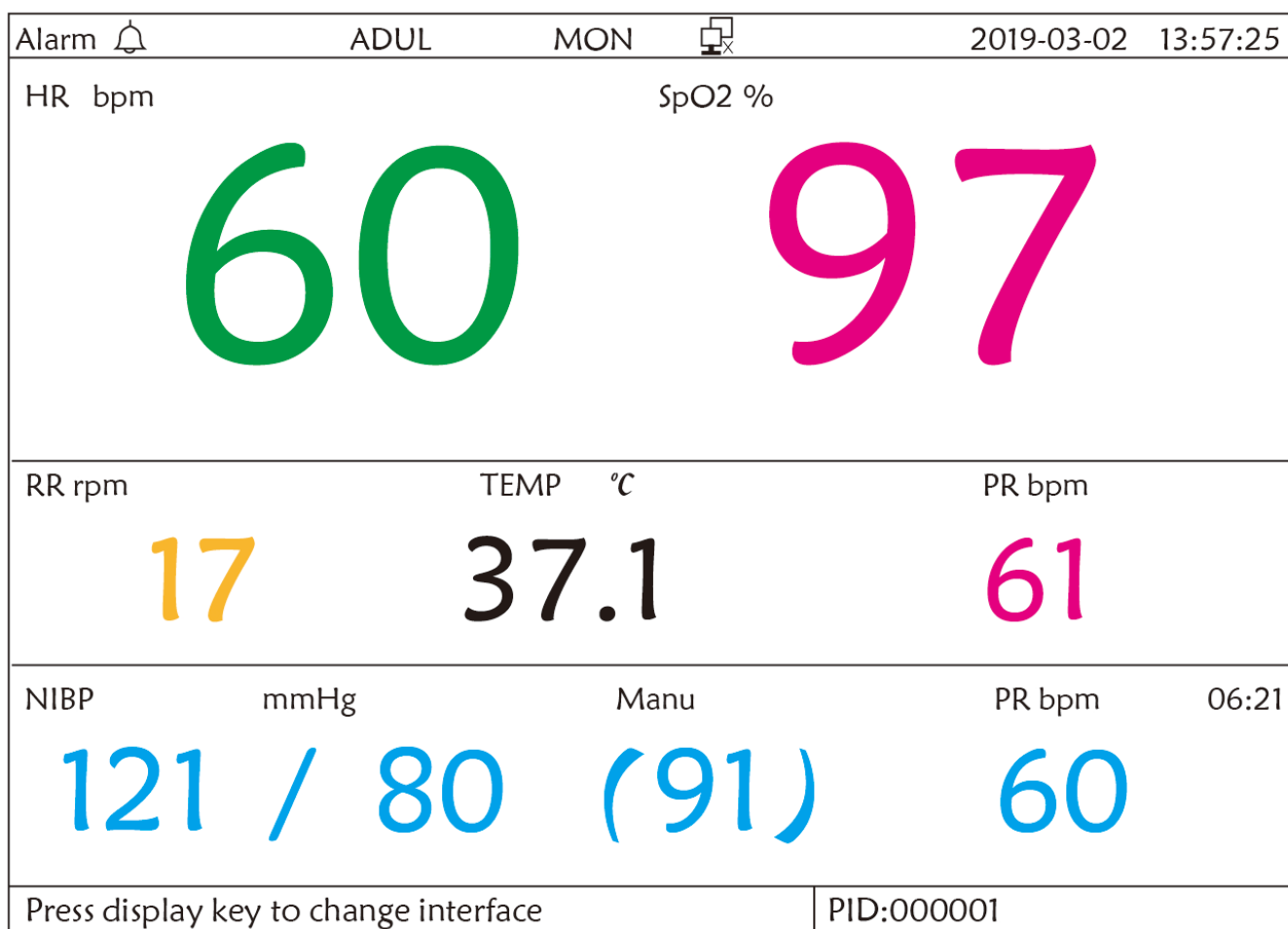

Figure 12.5A Parameter screen

### Operation Instructions:



**Alarm silence:** press it to enable or disable the alarm silence function.



**Freeze:** no action. Double press this key within 2 seconds to lock or unlock the operation of all other buttons (except power switch) on the front panel.



**NIBP:** press to start or stop NIBP measurement.



**DISP:** press it to shift the display to the Initial Screen.

**Navigation Knob:** no action.

## Chapter 13 Battery











### 13.1 Overview

The monitor has built-in chargeable battery, when the monitor is disconnected from the external AC power supply, then it turns to be powered by built-in battery. When the monitor is supplied by external AC power, then the battery will be charged. Generally, it's unnecessary to maintain the battery when using under normal working condition.

When the monitor is powered by built-in battery, and battery is in low voltage, then technical alarm will be triggered, and message "Low battery" pops up. At this moment, the user should connect the external power immediately to make sure the monitor continue working.

The capacity of the internal battery is limited. If the battery charge is too low, a technical alarm will be triggered and the message displayed. At this moment, apply AC/DC power to the monitor. Otherwise, the monitor will power off automatically before the battery is completely depleted.

### 13.2 Battery Maintenance

-  Please pay attention to the polarity of battery, do NOT insert it into battery compartment with reversed polarities;
-  Do NOT use the batteries manufactured by other companies, if being inserted, the device will may be damaged;
-  In order to avoid damaging the battery, do NOT use other power supply device to charge the battery;
-  After battery ageing phenomenon occurs, do NOT throw the battery into fire to avoid explosion risk.
-  Do not hit or strike it with force;
-  Do not use this battery on other devices;
-  Do not use this battery below -10°C or above 40°C;
-  Dispose of the battery, the local law should be followed.
-  In order to maintain battery supply time and prolong battery lifetime, please charge the battery every one or two months if don't use battery for a long time. Charge battery at least 12-15 hours every time. Before charging, run down the internal battery until the monitor turn off automatically to minimize memory effects. Charging time will be the same no matter whether the monitor is working or not. Charge fully before putting the monitor into storage.
-  Using a monitor powered solely by an internal battery which has short charge power will cause the monitor turn off automatically when the battery is depleted..
-  Do not use batteries manufactured by other companies, which may cause damage to the device. If battery is damaged, please replace with same type and specification battery marked by "CCC" or "CE" in time, or contact the company directly.

**Warning:**

1. To avoid battery damage always remove battery(s) before shipping or storage.
2. It is recommend to use the battery specified by the manufacturer.
3. Life expectancy of a battery depends on how frequently and how long it is used. For a properly maintained and stored lead-acid or lithium battery, its life expectancy is about 2 or 3 years respectively. For more aggressive use mode, life expectancy can be less. We recommend replacing lead acid battery every 2 years and lithium battery every 3 years.

**Caution:**

- Keep the battery out of the reach of children.
- Do not disassemble battery.

### 13.3 Battery Recycling

When a battery has visual signs of damage, or no longer holds a charge, it should be replaced. Remove the old battery from the monitor and recycle it properly. To dispose of the batteries, follow local laws for proper disposal.



# Chapter 14 Cleaning and Disinfection

## 14.1 Cleaning the Device and Accessories

Your device should be cleaned on a regular basis. If there is heavy pollution or lots of dust and sand in your place, the device should be cleaned more frequently. Before cleaning the equipment, consult your hospital's regulations for cleaning the device.

Recommended cleaning agents are:

- ✧ Sodium hypochlorite bleach (diluted)
- ✧ Hydrogen peroxide (3%)
- ✧ 75% Ethanol
- ✧ 70% Isopropanol

To clean your device, follow these rules:

- **Switch off the monitor and disconnect the power cable before cleaning.**
  - ✧ Kept the monitor from dust.
  - ✧ It is recommended to clean the outer shell and screen of the monitor to keep it clean. Only non-corrosive cleanser such as clear water is permitted.
  - ✧ Wipe the surface of the monitor and transducers with an Ethanol impregnated wipe, and dry it with dry and clean wipe or simply air-dry.
  - ✧ This monitor can be disinfected, please clean the monitor firstly.
- **Do not let the liquid cleanser flow into the connector jack of the monitor to avoid damage.**
- **Clean the exterior of the connector only.**
  - ✧ Dilute the cleanser.
  - ✧ Do not use scrub materials.
  - ✧ Do not let any liquid flow into the shell or any parts of the monitor.
  - ✧ Do not let the cleanser and disinfectant stay on its surface.
  - ✧ Do not perform high pressure sterilization to the monitor.
  - ✧ Do not put any parts of the monitor or its accessories in the liquid.
  - ✧ Do not pour the disinfectant on its surface while disinfectant.
  - ✧ If the monitor is accidentally wet, it should be thoroughly dried before use. The rear cover can be removed by qualified service technician to verify absence of water.
  - ✧ Never use this machine in an environment with inflammable gas.
  - ✧ Avoid being hit by lightning. The power cable should be plugged into an outlet with grounding wire. Do not

use an outlet with poor condition. If possible, use power supply system with regulator.





- ✧ It must be used in a clean environment protected against shock. Keep it away from corrosive substances, explosive substances, high temperature and dampness.
- ✧ If it is installed in a cabinet, make sure the installation allows for good ventilation, and easy maintenance, observation and operation.

## 14.2 Disinfecting the Device and Accessories

Disinfection may cause damage to the device and is therefore not recommended for this monitor unless otherwise indicated in your hospital's servicing schedule. Cleaning device before disinfecting is recommended.

The recommended disinfects include:

- 75% Ethanol
- 70% Isopropanol

-  Do not use damaged accessories.
-  Accessories can not be entirely immersed into water, liquor or cleanser.
-  Do not use radiation, steam or EO to disinfect accessories.
-  Do wipe off the remained Ethanol or isopropanol on the accessories after disinfection, for good maintenance can extend the life of accessories.
-  Single-use accessories are not designed to be reused. Reuse may cause a risk of contamination and affect the measurement accuracy.

## Chapter 15 Maintenance

In case of trouble of this machine in the service, follow the instructions below to eliminate the problem first. If the attempt fails, refer to the dealer in your local area or the manufacturer. Refer to the detailed provisions in contract for the warranty period of the main unit and the accessories of this monitor.

### 15.1 Daily Examination

Before using the monitor, the checks below should be carried out:





- ✧ Check the monitor for any mechanical damage;
- ✧ Inspect the exposed parts and the inserted parts of all the cables and the accessories;
- ✧ Examine all the functions of the monitor that are likely to be used for patient monitoring, and ensure that it is in good working condition;
- ✧ Make sure that the monitor is grounded properly.
- ✧ Pay close attention to the fluctuation of the local power supply voltage. A power voltage regulator is recommended when necessary.

In case any indication of damage about the function of the monitor is detected and proven, it is not allowed to apply it to the patient for any monitoring. Please contact the local dealer or our company, and we are to offer the best solution as soon as possible for your satisfaction.

### 15.2 Routine Maintenance

At each routinely maintenance or the yearly maintenance, the monitor can be thoroughly inspected by qualified personnel, including performance and safety examinations. This monitor is designed with life cycle of 5 years. It is strongly recommended to use the product which is still within its life cycle, or it may cause inaccurate measurement. In order to ensure its long service life, please pay attention to the maintenance.

- If the hospital fails to carry out a satisfactory maintenance program about the monitor, it may get disabled and harm the patient's safety and health.
- Perform protective grounding impedance, leakage current and insulation resistance test.
- In case of ECG cable/lead wires damage or aging, please replace the cable or lead wires.
- If there is any indication of cable and transducer damage or they deteriorate, they are prohibited from any further use.
- The Monitor is calibrated in the factory before sale, so there is no need to calibrate it during its life cycle. Any patient simulators should not be used to validate the accuracy of blood pressure and oxygen saturation measurement, they can only be used as functional testers to verify its precision.
- 🔔 The accuracy of ECG signal amplification can be verified by the built-in 1mV calibration signal.
- 🔔 The accuracy of pressure measurement and air leakage in pneumatic system can be verified by means of the built-in pressure verification function and a precision pressure meter, please refer to the related chapter in Part 2 of the user manual for detail operation.

-  The SpO<sub>2</sub> simulator can not be used to verify the SpO<sub>2</sub> measuring accuracy, which should be supported by the clinical study conducted by inducing hypoxia on healthy, non-smoking, light-to-dark-skinned subjects in an independent research laboratory. However it is necessary for the user to use SpO<sub>2</sub> simulator for routine verification of precision.
-  Please note that the specific calibration curve (so called R-curve) should be selected when use of SpO<sub>2</sub> simulator, e.g. for Index 2 series SpO<sub>2</sub> simulator from Fluke Biomedical Corporation, please set "Make" to "DownloadMake: KRK", then the user can use this particular R-curve to test the SpO<sub>2</sub> function. If the SpO<sub>2</sub> simulator does not contain "KRK" R-curve, please ask the manufacturer for helping to download the given R-curve into the SpO<sub>2</sub> simulator.
-  The adjustable units within the monitor such as potentiometers are not allowed to adjust without permission to avoid unnecessary failures that affect normal application.
-  It is recommended to use the battery once a month to ensure its power capability and long service life, and recharge it after run out of its power capacity.

### 15.3 ECG Verification

The ECG signal may be inaccurate due to hardware or software problems. As a result, the ECG wave amplitude becomes greater or smaller.

You can print out the square wave and wave scale and then measure the difference between them if necessary. If the difference exceeds 5%, contact your service personnel.

### 15.4 Pressure Accuracy Verification

Pressure Accuracy Verification is a function to inspect the accuracy of pressure measurement by the NIBP module inside the device. Technician or equipment manager should do pressure accuracy verification every half year or year in order to check if the pressure measurement still conforms to the requirement of product performance. If the deviation is beyond the declared specification, it is permitted to return it to factory for repair or calibration.

Before verification, please connect the monitor to a precision pressure meter as the reference equipment like a mercury pressure meter

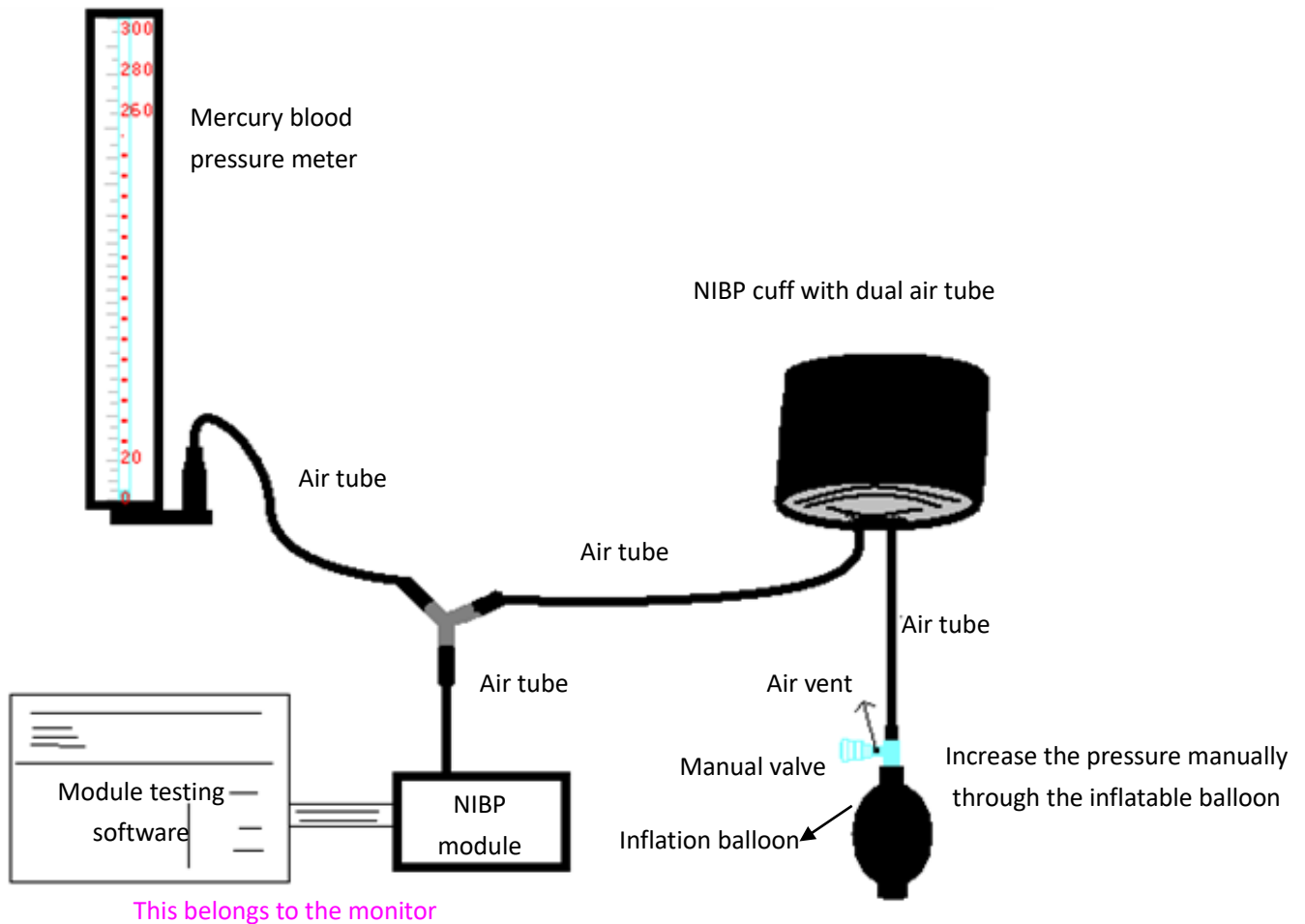

### Mode 1: Automatic inflation for the pressure accuracy verification

At this mode, the monitor can activate the inflation, so the pressure will increase automatically until it exceeds the limit value specified in table A. This pressure limit value depends on the patient type selection as shown in table A:

Adult	240mmHg
Pediatric	200mmHg
Neonate	120mmHg

Table A



During the inflation, the Monitor will close the deflating valve, and the pressure value will be shown during the process. If there is no manual deflation operation, the pressure will persist until deflation by manual operation, so it is necessary to use a manual valve for doing adequate deflation in several steps to verify the pressure accuracy in the full scale of measurement range.

### Mode 2: Manual inflation for the pressure accuracy verification.

At this mode, the pressure should be increased manually by a pumping balloon, and the verification can be done by applying different pressure value manually. If the increased pressure exceeds the given limit as shown in table B, the Monitor will deflate automatically because of over-pressure protection.

Adult	300mmHg
Pediatric	240mmHg
Neonate	140mmHg

Table B

-  After the verification, do press the button again to return to normal working mode, then continue other operation, or the NIBP key will be invalid.
-  Pressure accuracy verification must be operated by technician or equipment manager. Doctor or nurse is not allowed to do the verification, it is very dangerous especially when the pressure cuff is still on patients.

➤ **Air Leakage Check**

In order to avoid significant error of blood pressure measurement or even no measurement result caused by air leakage in the pneumatic system including the cuff during measuring, it is recommended to check if there is leak in the pneumatic system as well.

**Please remove the cuff from patient while performing the leakage check.**

## 16 Accessories

 Check the accessories and their package for any signs of damage. Do not use them if any damage is detected.

Item	Description	Material No.	Remark
1	PC-3000 Main set	/	
2	Handle Subassembly	/	
3	Adult SpO <sub>2</sub> probe	15044074	
4	NIBP cuff	15020013	
5	ECG cable	15010012	
6	ECG electrode	5101-0101310	
7	Power cord	2903-0100002	
8	Power Adapter	2301-0000011	
9	Li-ion battery	2302-1482200	
10	Quality certification	3503-0100044	
11	User manual	3502-1560013	
12	Net wire	900093	
13	Disposable TEMP Probe Cover	3101-0000007	Optional
14	Quick TEMP Instruction	3502-1530028	Optional
15	Temperature probe	15080000	Optional

For more information regarding the accessories, please contact your local sales representative or the manufacturer.

Note: Part No. is subject to change without prior notice, please refer to the label of parts or package list.

## 17 Technical Specifications

### 17.1 ECG

1. Input dynamic range:  $\pm(0.5\text{mVp} \sim 5\text{mVp})$
2. Heart rate display range: 15 bpm  $\sim$  350 bpm ( for Adult and Pediatric)
3. Heart rate display accuracy:  $\pm 1\%$  or  $\pm 2\text{bpm}$ , whichever is greater.
4. Heart rate averaging: Averages the recent eight beats having RR intervals falling within the acceptable limits.
5. Defibrillation recovery time:  $\leq 10$  sec
6. Alarm signal (for any alarm source) generation delay time:  $< 1$  sec  
Heart rate alarm condition delay time:  $\leq 10$  sec
7. Response time to change in heart rate:
  - Change from 80bpm to 120bpm:  $< 8$  sec
  - Change from 80bpm to 40bpm:  $< 8$  sec
8. Tall T-wave rejection: Rejects all T-wave less than or equal to 120% of 1mV QRS.
9. Pacemaker pulse rejection:
  - Rejects all pulses of amplitude  $\pm 2\text{mV}$  to  $\pm 700\text{mV}$  and duration 0.1 to 2 ms without overshoot;
10. Sensitivity selection:  $\times 1/4$ ,  $\times 1/2$ ,  $\times 1$ ,  $\times 2$ ,  $\times 4$  and AUTO
  - $\times 1/2$ , 5mm/mV tolerance:  $\pm 5\%$
  - $\times 1$ , 10mm/mV tolerance:  $\pm 5\%$
  - $\times 2$ , 20mm/mv tolerance:  $\pm 5\%$
11. Sweeping speed: 6.25mm/s, 12.5mm/s, 25mm/s, 50mm/s tolerance:  $\pm 10\%$
12. ECG noise level:  $\leq 30\mu\text{V}_{\text{P-P}}$ .
13. ECG input loop current:  $\leq 0.1\mu\text{A}$
14. Differential input impedance:  $\geq 10\text{M}\Omega$
15. Common-mode rejection ratio (CMRR):
  - In Diagnostic mode:  $\geq 90\text{dB}$       In Operation and Monitoring mode:  $\geq 105\text{dB}$
16. Time constant:
  - Monitoring mode:  $\geq 0.3\text{s}$       Diagnostic mode:  $\geq 3.2\text{s}$
17. Frequency response:
  - Operation mode:  $1\text{ Hz} \sim 20\text{Hz} \left( \begin{matrix} +0 \\ -3 \end{matrix} ; \begin{matrix} 4 \text{ d B} \\ 0 \text{ d B} \end{matrix} \right)$
  - Monitoring mode:  $0.67\text{ Hz} \sim 40\text{Hz} \left( \begin{matrix} +0 \\ -3 \end{matrix} ; \begin{matrix} 4 \text{ d B} \\ 0 \text{ d B} \end{matrix} \right)$
  - Diagnostic mode:  $0.05\text{ Hz} \sim 150\text{Hz} \left( \begin{matrix} +0 \\ -3 \end{matrix} ; \begin{matrix} 4 \text{ d B} \\ 0 \text{ d B} \end{matrix} \right)$



## 17.2 RESP

1. RESP rate measuring range: 0rpm~120rpm
2. RESP rate accuracy:  $\pm 5\%$  or  $\pm 2$  rpm, whichever is greater
3. RESP rate alarm limit setting range: High: 1rpm~150rpm; Low: 0rpm~149rpm.
4. Alarm tolerance:  $\pm 1$ rpm

## 17.3 TEMP

1. TEMP measuring range: 21.0°C~50.0°C
2. TEMP measuring accuracy:  $\pm 0.2$  °C for the range from 25°C to 45°C, 0.4 °C for other ranges.
3. TEMP responding time:  $\leq 150$ s
4. TEMP minimum measuring time:  $\geq 130$ s
5. Measuring site: body surface
6. Mode of operation: direct mode
7. Unit: °C and °F
8. TEMP alarm limit setting range: High: 0°C~60°C; Low: 0°C~59.9°C.
9. Tolerance:  $\pm 0.1$ °C

## 17.4 NIBP

1. Measuring method: Oscillometric Technique
2. Pneumatic pressure measuring range: 0 mmHg~300mmHg
3. Accuracy of pressure measurement:  $\pm 3$  mmHg
4. Typical measurement time: <30 seconds (adult cuff)
5. Measurement time on the average: < 90 seconds
6. Air release time while the measurement is canceled: <2 seconds (typical adult cuff)
7. Initial cuff inflation pressure  
Adult: <150 mmHg; Infant: <120 mmHg; Neonate: <70 mmHg Tolerance:  $\pm 5$  mmHg
8. Overpressure protection limit  
Adult: 300 mmHg; Infant: 240mmHg; Neonate: 150 mmHg
9. NIBP measurement range:

Pressure (unit)		Adult	Infant	Neonate
SYS	mmHg	40~275	40~200	40~135
	kPa	5.3~36.7	5.3~26.7	5.3~18.0
MAP	mmHg	20~230	20~165	20~110
	kPa	2.7~30	2.7~22.0	2.7~14.6
DIA	mmHg	10~210	10~150	10~95
	kPa	1.3~28	1.3~20.0	1.3~12.7

10. NIBP accuracy:
  - Maximum mean difference:  $\pm 5$  mmHg
  - Maximum Standard deviation: 8 mmHg
11. Measurement mode: Manual, Auto, STAT
12. NIBP Alarm setting range: **see Section Alarms**

## 17.5 SpO<sub>2</sub>

1. Transducer: dual-wavelength LED
    - Wavelength: Red light: 660 nm, Infrared light: 905 nm
    - Maximal optical output power: less than 2mW maximum average
  2. SpO<sub>2</sub> measuring range: 0%~100%
  3. SpO<sub>2</sub> measuring accuracy: Arms\* is not greater than 2% for SpO<sub>2</sub> range from 70% to 100%
- \*NOTE: Arms is the accuracy defined as root-mean-square value of deviation according to ISO 80601-2-61.
4. Alarm range: High: 1%~100%; Low: 0%~99%
  5. Low perfusion performance: the declared accuracy is sustained when the pulse amplitude modulation ratio is as low as 0.3%

### Data averaging and update:

The displayed SpO<sub>2</sub> and Pulse Rate values are the average of data collected within a specific time. The SpO<sub>2</sub> is calculated every second by the data collected in recent 5 seconds, the Pulse Rate is calculated for every beat. The averaging method depends on the pulse rate value, for pulse rates below 50bpm, the SpO<sub>2</sub> is averaged by 16-second sliding average, the Pulse Rate is averaged by 4-beat sliding average; for pulse rates between 50bpm and 120bpm, the SpO<sub>2</sub> is averaged by 8-second sliding average, the Pulse Rate is averaged by 8-beat sliding average; for pulse rates above 120bpm, the SpO<sub>2</sub> is averaged by 4-second sliding average, the Pulse Rate is averaged by 16-beat sliding average.

The screen display of SpO<sub>2</sub> and Pulse Rate are updated every second with the most recent value, if the signal is noisy or missing, the display will hold the last value for at most 15 seconds before showing dashes.

The over-limit alarm is triggered once the SpO<sub>2</sub> or Pulse Rate exceeds the preset limits, the alarm signal generation delay is small (less than 1 second) compared with the alarm condition delay, which is caused by the data average as described above.

## 17.6 Pulse Rate

1. Pulse rate measuring range: 0bpm~250bpm
2. Pulse rate measurement accuracy:  $\pm 2$ bpm or  $\pm 2\%$ , whichever is greater.
3. Alarm range: High: (1~300) bpm; Low: (0~299) bpm
4. Pulse rate alarm tolerance:  $\pm 2$ bpm within (30~250) bpm

Note: The pulse rate ACCURACY is tested by an electronic pulse simulator.

## 17.7 S-T Segment

1. Measuring range:  $-2.0\text{mV}\sim+2.0\text{mV}$
2. Tolerance:  $-0.8\text{mV}\sim+0.8\text{mV}$       $\pm 0.02\text{mV}$  or  $\pm 10\%$  (which is greater)

## 17.8 Data Recording

1. Sensitivity selection tolerance:  $\pm 5\%$
2. Recording speed:  $25\text{mm/s}$
3. Recording speed accuracy:  $\pm 10\%$
4. Hysteresis:  $\leq 0.5\text{mm}$
5. Frequency response:
  - Monitoring mode:  $0.5\sim 40\text{Hz}$      Diagnostic mode:  $0.05\sim 75\text{Hz}$
6. Time constant:
  - Monitoring mode:  $\geq 0.3\text{s}$      Diagnostic mode:  $\geq 3.2\text{s}$

## 17.9 Other Technical Specifications

1. Power supply: AC100V-240V, 50/60Hz, 60VA; Internal power supply (Lithium battery): DC 14.8V
2. Mode of operation: Continuous
3. Applied Part: ECG lead wire, SpO<sub>2</sub> sensor, TEMP sensor and Cuff
4. Display mode: TFT color LCD
5. Alarming mode: audible & visible alarm
6. Communication: Net port

## 17.10 Classification

<b>Safety standard:</b>	<b>IEC 60601-1</b>
The type of protection against electric shock	Class I and Internally powered equipment
The degree of protection against electric shock	Defibrillation-proof BF and Defibrillation-proof CF applied parts
Electro-Magnetic Compatibility:	Group I, Class A
The protection against harmful ingress of liquid or particulate matter	IPX2

The device is not intended for use in an oxygen rich environment.

The surface of the device can be cleaned and disinfected with 75% Ethanol, no need to sterilize.

## 17.11 Operating Environment

1. Ambient temperature range: 5°C~40°C

Relative humidity: 15%~85%, non-condensing

Atmospheric pressure: 70kPa ~106.0kPa

Power Voltage: (100-240)VAC

Power frequency: 50Hz/60Hz

2. This equipment should be situated in a place protected against direct sunlight, so as to prevent overheating inside the equipment.
3. The device should be stored and used within specified temperature, humidity and atmospheric pressure range, or it may cause damage to the device or inaccurate measurement result.
4. If the device gets wet by accident, the operator should NOT power it on directly until it has been air-dry enough to avoid any damage to it.
5. Do not use this equipment in an environment with toxic or inflammable gas.
6. This equipment should be placed on a stand or flat platforms, so as to prevent possible shock.
7. Do not use this equipment in combination with any equipment other than those expressly permitted in the manual.
8. The monitor is defibrillator discharge proof and can be used with electrosurgical unit. But when the device is used together with defibrillator or electrosurgical equipment, the user (doctor or nurse) should keep the patient under close surveillance for his/her safety. Refer to the following function description for specific protective measures or notes.
9. Make sure that the equipotential grounding terminal is grounded correctly.
10. Do not use mobile phone nearby, so as to avoid strong radiant field interference.

## 17.12 Storage

If the equipment will not be used for long period of time, wipe it clean and keep it in the packaging, which shall be kept in a dry and good ventilation place free from dust and corrosive gases

Storage environment: ambient temperature: -20~60°C  
relative humidity: 10%~95%  
atmospheric pressure: 53kPa~106kPa

## 17.13 Transportation

This monitor should be transported by land (vehicle or railway) or air in accordance with the contractual terms. Do not hit or drop it with force.

Transportation environment: ambient temperature: -20~60°C

relative humidity: 10%~95%

atmospheric pressure: 53kPa~106kPa

## 17.14 Packaging

The product is packed in high quality corrugated cartons with foam inside to protect the apparatus against damage in the handling process.

Gross weight: Details see the indication on the outer package

Dimension: Details see the indication on the outer package

# Chapter 18 Troubleshooting

**Note:** In case of trouble of this machine in service, follow the instructions below to eliminate the problem first. If the attempt fails, contact the dealer in your local area or the manufacturer.

 **Do NOT open the monitor cabinet without permission**

## 18.1 No Display on the Screen

Shut down the machine and unplug the power cable. Use a universal meter to check if the outlet has proper voltage, if the power cable is in good condition, and if the power cable is properly connected with this apparatus or outlet. Remove the fuse from the back cover of this machine, and make sure it is in good condition. If all of above is in good condition, the display screen may be malfunction.

## 18.2 Excessive ECG Signal Interference or too Thick Baseline

1. Check if the plate electrodes are properly located, and if valid plate electrodes are used.
2. Check whether the lead wires are properly inserted. If no ECG curve displayed, check if the ECG lead wires are broken.
3. Make sure the mains outlet has standard grounding wire.
4. Check if the grounding wire of the apparatus properly grounded.

## 18.3 No Blood Pressure and Pulse Oxygen Measures

1. Check if the blood pressure cuff is properly wrapped around the arm according to the operating instructions, if the cuff leaks, and if the inlet is closely connected with the NIBP jack on the side panel. Check if the indicator of the pulse oxygen sensor flashes and if the pulse oxygen probe is properly connected to the SpO<sub>2</sub> jack on the side panel.
2. If the problems still exist, please contact the manufacturer.

## 18.4 System Alarm

1. When the parameter value is higher or lower than the alarm limits, the alarm will ring. Please check whether the alarm limit value is proper or the condition of the patient.
2. Leads off. Please check the connection of the leads.
3. Probe off. Please check the connection of the probes.

## 18.5 Alarm Problems

Symptoms	Possible cause	Correction action
The alarm LED does not light	Main board is defective	Replace the main board
No alarm sound is issued	Audible alarm is disabled	Check if the “  ” is displayed, if yes, the audible alarm is disabled.
	Speaker is defective	Replace the speaker
	Main board is defective	Replace the main board

## 18.6 Power Supply Failure

Symptoms	Possible cause	Correction action
Battery cannot be recharged and/or fully charged	Battery is defective	Replace the battery
	Main board is failure	Replace the main board

## A Alarm Information

Alarm Information	Descriptions
Over HR limit	The related parameter value exceeds the preset high/low alarm limits.
Over RR limit	
Over TEMP limit	
Over SpO <sub>2</sub> limit	
Over PR limit	
Over NIBP SYS limit	
Over NIBP DIA limit	
Over NIBP PR limit	
Unable to detect HR	ECG cable and leads are connected to monitor and patient well, but HR is unable to be detected. It may be caused by poor integrity of ECG signals.
Unable to detect SpO <sub>2</sub>	SpO <sub>2</sub> probe is connected to monitor and patient well, but SpO <sub>2</sub> is unable to be detected. It may be caused by poor plethysmogram signals.
The battery capacity will exhaust	Low battery voltage
Lead Off	The ECG electrodes or cable fell off
Probe Off	SpO <sub>2</sub> probe fell off



## B Status/Error during NIBP Monitoring

“Cuff error”	—cuff is not wrapped correctly, or is not connected
“Air leak”	—Air moving part, tube or the cuff leak air.
“Pressure error”	—Unstable cuff pressure or tangled cuff tubing
“Signal weak”	—Very weak signal because of the cuff, or the patient has very weak pulse
“Over extent”	—The measurement range exceeds 255 mmHg (Pediatric patient over 135 mmHg)
“Over motion”	—The repeated measurement due to moving, excessive noise during the stepping inflation and measuring pressure and pulse, e.g. during patient shaking motion
“Signal overflow”	—Blood pressure amplifier overflow due to excessive movement
“Leak in gas run”	—Leaking during the pneumatic device testing
“System error”	—Abnormal condition of CPU, such as register overflow, divided by zero
“Adult”	—The blood pressure measuring now is in adult mode. In this case, it is not allowed to monitoring Pediatric or neonatal patient. Otherwise, there may be serious danger to the Pediatric monitored.
“Pediatric”	—The blood pressure module is now worked in Pediatric measuring mode.
“PROBE OFF”	—SpO <sub>2</sub> probe fell off
“LEADS OFF”	—The ECG electrodes or cable fell off
“LEARNING”	—Learning arrhythmia for 15 seconds
“DEMO”	—The monitor is displaying the demo waveforms, which are generated by the monitor itself.

## C EMC Compliance

### Essential Performance

The monitor has the following essential performance in an environment of electromagnetic environment specified below:

Operating mode, accuracy, function, alarm

### Warnings

- Use of the monitor adjacent to or stacked with other equipment should be avoided because it could result in improper operation. If such use is necessary, this equipment and other equipment should be observed to verify that they are operating normally.
- Use of accessories, transducers and cables other than those specified or provided by the manufacturer of the monitor could result in increased electromagnetic emissions or decreased electromagnetic immunity of the monitor and result in improper operation.
- Portable RF communications equipment (including peripherals such as antenna cables and external antennas) should be used no closer than 30 cm (12 inches) to any part of the monitor, including cables specified by the manufacturer. Otherwise, degradation of the performance of the monitor could result.
- In operation mode, the monitor can be used with electro-surgical unit. The monitor's operator should ensure the safety of the patients if in use with electro-surgical unit in accordance with the instructions of this manual. After the elimination of high frequency signal and high frequency electromagnetic field, the monitor waveform and parameter can recover within 10 seconds without losing any stored data.
- Do not use the monitor with electro-surgical unit in non-operation mode, nor with large-scale electrical equipment such as ultrasonic, radiation and magnetic resonance imaging, which may cause electromagnetic interference to the monitor or harm the monitor's operator.

## Electromagnetic compatibility

### Levels of compliance with the EN 60601-1-2:2015 standard

- ESD immunity 15kV for air discharge 8 kV for contact discharge (EN 61000-4-2)
- 2kV/100kHz burst immunity (EN 61000-4-4) power supply/1kV signals
- Surge immunity (EN 61000-4-5): 1kV common/2kV differential
- Magnetic field (EN 61000-4-8): 30A/m
- Dip Immunity: 0% 0.5 cycles; 0% 1 cycle; 70% 25 cycles (50Hz) and 30 cycles (60Hz); Breaks: 250 cycles (50Hz); 300 cycles (60Hz)
- Immunity to RF currents in the range 150kHz-80MHz (EN 61000-4-6) 3V modulation 80% 1kHz 6V modulation 80% 1kHz for the following frequency ranges: 6.765 MHz ÷ 6.795 MHz 13.553 MHz ÷ 13.567 MHz 26.957 MHz ÷ 27.283 MHz 40.66 MHz ÷ 40.70 MHz
- CISPR 11 class A emissions
- EN 61000-3-2 class A Harmonic currents
- PST, DT, DC Flickers

RF field immunity (EN 61000-4-3):		
Field (V/m)	Frequency	Modulation
3	80MHz ÷ 2700MHz	1kHz AM 80%
27	380MHz ÷ 390MHz	18Hz PM 50%
28	430MHz ÷ 470MHz	18Hz PM 50%
9	704MHz ÷ 787MHz	217Hz PM 50%
28	800MHz ÷ 960MHz	18Hz PM 50%
28	1700MHz ÷ 1990MHz	217Hz PM 50%
28	2400MHz ÷ 2570MHz	217Hz PM 50%
9	5100MHz ÷ 5800MHz	217Hz PM 50%

#### WARNINGS:

Even though it complies with EN 60601-1-2, the medical device (DEVICE NAME) may interfere with other appliances nearby. The device should not be used next to or stacked with other equipment. Install the device away from other equipment which radiates high frequencies (short waves, microwaves, electrosurgical units, mobile phones).

The use of this device near to or placed on other appliances should be avoided, as this can lead to its incorrect operation. In these cases, the device and the other equipment should be kept under observation to verify their normal operation.

Transportable RF communications equipment (including peripherals such as antenna cables and external antennas) should be used no less than 30 cm (12 inches) away from any part of the [EM EQUIPMENT or EM SYSTEM], including the cables specified by the MANUFACTURER. Otherwise, performance degradation of this equipment may occur”













The device is designed to operate in an electromagnetic environment in which RF radiated disturbances are under control. The customer or the operator can help prevent electromagnetic interference by ensuring a minimum distance between mobile and portable RF communication devices (transmitters) and the medical device, as recommended below, in relation to the maximum output power of the radio communication devices.

Rated maximum output power of transmitter (W)	Distance (m) of separation according to the frequency of the transmitter		
	from 150kHz to 80MHz $d = 1.2 \sqrt{P}$	from 80MHz to 800MHz $d = 1.2 \sqrt{P}$	from 800MHz to 2.5GHz $d = 2.3 \sqrt{P}$
0.01	0.12	0.12	0.23
0.1	0.38	0.38	0.73
1	1.2	1.2	2.3
10	3.8	3.8	7.3
100	12	12	23

For transmitters whose rated maximum output power is not listed above, the recommended separation distance  $d$  in metres (m) can be calculated using the equation applicable to the transmitter frequency, where  $P$  is the rated maximum power transmitter output in Watts (W) according to the transmitter manufacturer.

**Notes:**

- (1) The highest frequency range must be applied at 80 MHz and 800 MHz
- (2) These guidelines may not apply to all situations. Electromagnetic propagation is affected by absorption and by the reflection from structures, objects and people.

	Caution: read instructions (warnings) carefully		Follow instructions for use
	Keep in a cool, dry place		Keep away from sunlight
	Manufacturer		Date of manufacture
	Product code		Defibrillation-proof type CF applied part
	Medical Device complies with Directive 93/42/EEC		Defibrillation-proof type BF applied part
	WEEE disposal		Serial number



**Disposal:** *The product must not be disposed of along with other domestic waste. The users must dispose of this equipment by bringing it to a specific recycling point for electric and electronic equipment.*

**GIMA WARRANTY TERMS**

The Gima 12-month standard B2B warranty applies.