

KERN

KERN & Sohn GmbH

Ziegelei 1
D-72336 Balingen
E-Mail: info@kern-sohn.com

Phone: +49-[0]7433- 9933-0
Fax: +49-[0]7433-9933-149
Internet: www.kern-sohn.com

Operating manual Medical Stand assist scales

KERN MTA

Type MTA 400K-1NM
Version 1.1
2017-12
GB



MTA-BAPS-e-1711



Contents

| | | |
|-----------|---|-----------|
| 1 | Technical data | 4 |
| 2 | Declaration of conformity | 5 |
| 3 | Appliance overview | 5 |
| 4 | Keyboard overview | 7 |
| 5 | Overview of display | 8 |
| 6 | Basic instructions | 9 |
| 6.1 | Proper use | 9 |
| 6.2 | Improper Use | 9 |
| 6.3 | Warranty | 10 |
| 6.4 | Monitoring of Test Resources | 10 |
| 7 | Basic Safety Precautions | 10 |
| 7.1 | Pay attention to the instructions in the Operation Manual..... | 10 |
| 8 | Transport and storage | 11 |
| 8.1 | Testing upon acceptance | 11 |
| 8.2 | Packaging / return transport..... | 11 |
| 9 | Unpacking, Setup and Commissioning | 12 |
| 9.1 | Installation Site, Location of Use | 12 |
| 9.2 | Unpacking | 12 |
| 9.3 | Scope of delivery | 13 |
| 9.4 | Balance assembly and installation | 13 |
| 9.5 | Mains connection | 16 |
| 9.6 | Battery operation with optional battery power pack | 17 |
| 9.7 | Battery operation..... | 18 |
| 9.8 | Insert batteries/rechargeable batteries on the example of batteries:..... | 18 |
| 9.9 | Initial Commissioning | 19 |
| 10 | Operation | 19 |
| 10.1 | Weighing..... | 19 |
| 10.2 | Taring | 20 |
| 10.2.1 | Subsequent tare weight | 21 |
| 10.3 | HOLD function | 21 |
| 10.4 | Display additional decimal point | 21 |
| 10.5 | Calculation of the Body Mass Index | 22 |
| 10.5.1 | Calculating Body Mass Index..... | 22 |
| 10.5.2 | Classification of BMI values | 23 |
| 10.6 | Automatic switch-off function „AUTO OFF“ | 24 |
| 10.7 | Display background illumination..... | 25 |
| 11 | Menu | 26 |
| 11.1 | Navigation in the menu | 26 |
| 11.2 | Menu overview..... | 27 |
| 12 | Data output RS 232 | 30 |

| | | |
|-----------|---|-----------|
| 12.1 | Pin allocation of balance output bushing: | 30 |
| 12.2 | Technical data | 30 |
| 12.3 | Printer operation | 31 |
| 13 | Error messages | 32 |
| 14 | Servicing, maintenance, disposal..... | 33 |
| 14.1 | Cleaning | 33 |
| 14.2 | Cleaning / Disinfecting | 33 |
| 14.3 | Sterilisation | 33 |
| 14.4 | Servicing, maintenance..... | 33 |
| 14.5 | Disposal..... | 33 |
| 15 | Instant help | 34 |
| 16 | Adjustment | 36 |

1 Technical data

| KERN (Type) | MTA 400K-1NM |
|---|--|
| Trademark | MTA 400K-1M |
| Readability (d) | 0.1 kg / 0.2 kg |
| Weighing range (max) | 300 kg / 400 kg |
| Reproducibility | 0.1 kg / 0.2 kg |
| Linearity | ±0.1 kg / ±0.2 kg |
| Recommended adjustment weight (Class) | 400 kg (M1) |
| Weighing Units | kg |
| Warm-up time | 10 min |
| Electric Supply | Input Voltage: 100 V - 240 V, 50/60 Hz |
| Operating temperature | 10°C ... + 40°C |
| Humidity of air | max. 80 % (not condensing) |
| Dimensions (B x D x H) mm | Display housing 200 x 128 x 55 Weighing platform 780 x 680 x 68 Weighing surface 600 x 600 |
| Weight kg (net) | 40 |
| Rechargeable battery operation optional | Service life background illumination ON: 20 h Service life: background illumination OFF: 40 h Loading time 12 h 6 x 1.2 V 2000 mA |
| RS -232 interface | ✓ |
| Tripod | Height: 94 cm |

2 Declaration of conformity

To view the current EC/EU Declaration of Conformity go to:

www.kern-sohn.com/ce

3 Appliance overview

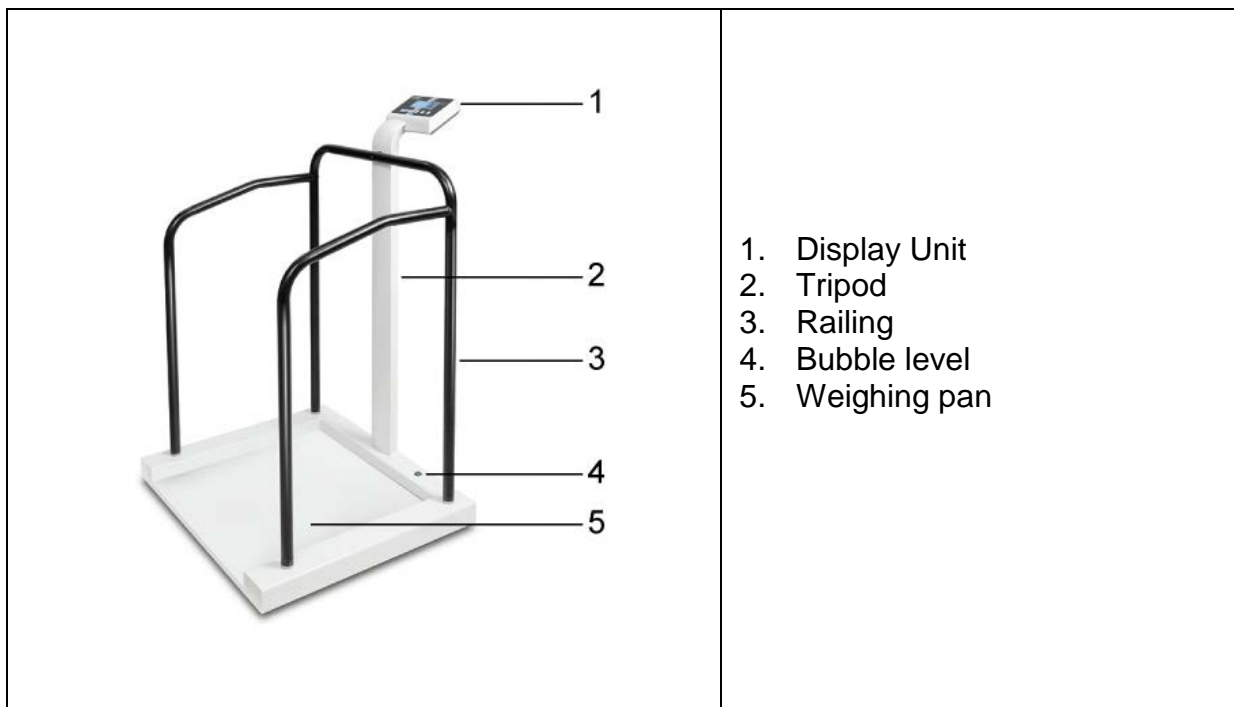

Secondary display at rear



Display unit at rear

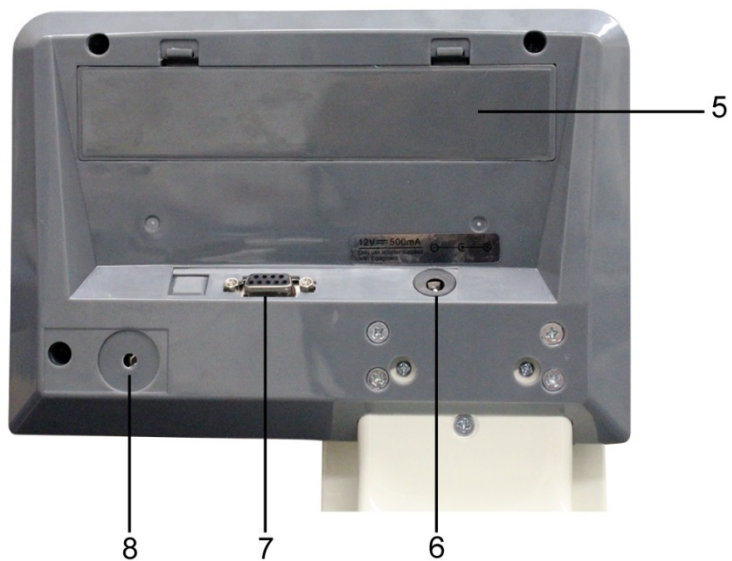





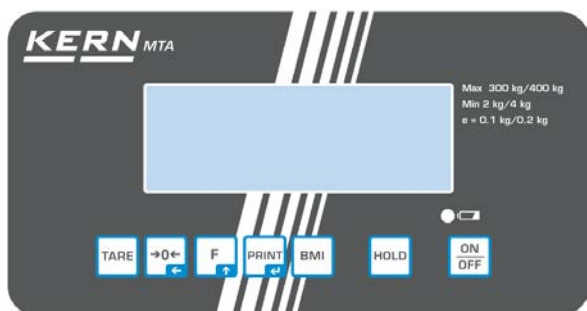

- 5 Rechargeable battery / battery compartment
- 6 Mains port
- 7 RS 232 C
- 8 Adjustment switch





4 Keyboard overview



Type MTA 400K-1NM

| Button | Designation | Function |
|---|---------------|--|
|  | ON/OFF button | Turn on/off |
|  | HOLD button | Hold function/Calculation of a stable weight value |
|  | BMI key | Calculation of the Body Mass Index |
|  | PRINT button | Data transfer via interface In menu: <ul style="list-style-type: none"> • Confirm selection For numeric entry: <ul style="list-style-type: none"> • Confirm numerical value |
|  | Function key | In menu: <ul style="list-style-type: none"> • Call up menu • Select menu items For numeric entry: <ul style="list-style-type: none"> • Increase numerical value |
|  | Zeroing key | Weighing scale will be reset to „0.0“ For numeric entry: <ul style="list-style-type: none"> • Change decimal place |
|  | TARE key | Tare balance |

5 Overview of display

| Display | Designation | Description |
|---|--|--|
| STABLE | Stability display | Scales are in a steady state |
| ZERO | Zeroing display | Should the balance not display exactly zero despite empty weighing plate, press the  button. Your balance will be set to zero after a short standby time. |
| NET | Net weight display | Illuminated when net weight is displayed Illuminated after weighing scale was tared |
| GROSS | Gross weight display | Illuminated when gross weight is displayed |
| HOLD | HOLD function | HOLD function active |
| BMI | BMI function | Illuminated while BMI function is enabled |
|    | Rechargeable battery / battery display | Displays the capacity of the rechargeable battery or of the batteries |

6 Basic instructions

6.1 Proper use

The scales is used for determining the body weight of people in standing position.

In the case of body scales, the person being weighed needs to stand in the middle of the scales' plate and remain calm in the standing position.

The value may be read after the scales stabilizes.

The scales is designed for continuous use.



The weighing platform may only be stepped on by persons capable of standing on both feet on the weighing platform.

The balance should be checked for correct condition prior to each utilisation by a person familiar with proper operation of the balance.

6.2 Improper Use

Do not use these scales for dynamic weighing processes.

Do not leave permanent load on the weighing pan. This may damage the measuring system.

Impacts and overloading exceeding the stated maximum load (max) of the weighing plate, minus a possibly existing tare load, must be strictly avoided. This could cause damage to the balance.

Never operate balance in explosive environment. The serial version is not explosion protected. It should be noted that a flammable mixture of anaesthetics and oxygen or laughing gas may occur.

The structure of the balance may not be modified. This may lead to incorrect weighing results, safety-related faults and destruction of the balance.

The balance may only be used according to the described conditions. Other areas of use must be released by KERN in writing.

Do not use the scales for determining body weight in medicine.

6.3 Warranty

Warranty claims shall be voided in case



- Our conditions in the operation manual are ignored
- The appliance is used outside the described uses
- The appliance is modified or opened
- Mechanical damage and damage caused by media, liquids,
- Natural wear and tear
- The appliance is improperly set up or incorrectly electrically connected
- The measuring system is overloaded
- Dropping the balance

6.4 Monitoring of Test Resources

In the framework of quality assurance the measuring-related weighing properties of the balance and, if applicable, the testing weight, must be checked regularly. The responsible user must define a suitable interval as well as type and scope of this test. Information is available on KERN's home page (www.kern-sohn.com) with regard to the monitoring of balance test substances and the test weights required for this. In KERN's accredited DKD calibration laboratory test weights and balances may be calibrated (return to the national standard) fast and at moderate cost.

7 Basic Safety Precautions

7.1 Pay attention to the instructions in the Operation Manual

| | | |
|---|---|---|
|  | ⇒ Carefully read this operation manual before setup and commissioning, even if you are already familiar with KERN balances. |  |
|---|---|---|

8 Transport and storage

8.1 Testing upon acceptance

When receiving the appliance, please check packaging immediately, and the appliance itself when unpacking for possible visible damage.

8.2 Packaging / return transport



- ⇒ Keep all parts of the original packaging for a possibly required return.
- ⇒ Only use original packaging for returning.
- ⇒ Prior to dispatch disconnect all cables and remove loose/mobile parts.
- ⇒ Reattach possibly supplied transport securing devices.
- ⇒ Secure all parts such as the weighing platform, power unit etc. against shifting and damage.

9 Unpacking, Setup and Commissioning

9.1 Installation Site, Location of Use

The balances are designed in a way that reliable weighing results are achieved in common conditions of use.

You will work accurately and fast, if you select the right location for your balance.

On the installation site observe the following:

- Place balance on a stable, even surface;
- Avoid extreme heat as well as temperature fluctuation caused by installing next to a radiator or in the direct sunlight;
- Protect the balance against direct draughts due to open windows and doors;
- Avoid jarring during weighing;
- Protect the balance against high humidity, vapours and dust;
- Do not expose the device to extreme dampness for longer periods of time. Non-permitted condensation (condensation of air humidity on the appliance) may occur if a cold appliance is taken to a considerably warmer environment. In this case, acclimatize the disconnected appliance for ca. 2 hours at room temperature.
- Avoid static charge of the balance and of the person to be weighed.
- Avoid contact with water.

Major display deviations (incorrect weighing results) may be experienced should electromagnetic fields (e.g. due to mobile phones or radio equipment), static electricity accumulations or instable power supply occur. Change location or remove source of interference.





9.2 Unpacking

Remove the individual components of the balance or the complete balance from the packaging with care and install at the intended location. When using the power pack, ensure that the power cable does not produce a risk of stumbling.

9.3 Scope of delivery

Serial accessories:

- Balance with display unit and tripod
- Mains adapter
- Operating manual
- 4 x adjustable feet
- Screws / small parts

| | | | |
|---|---|---|---|
|  |  |  |  |
| x 2 | x 8 | x 2 | x 2 |

9.4 Balance assembly and installation

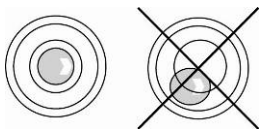

⇒ Level balance with foot screws until the air bubble of the water balance is in the prescribed circle.

⇒ Check levelling regularly.

Refitting Procedure:

Plug-in tripod acc. to illustration in the provided opening in the frame.

Ensure that the cable is not squeezed.

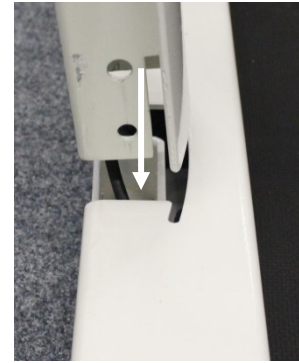
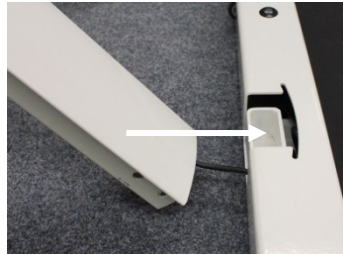

Screw down tripod at the weighing plate:

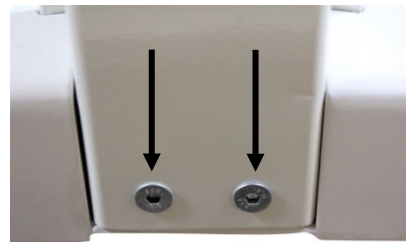

Place the hand rail of the tripod on the provided pins and fix it with the screws at the base plate.

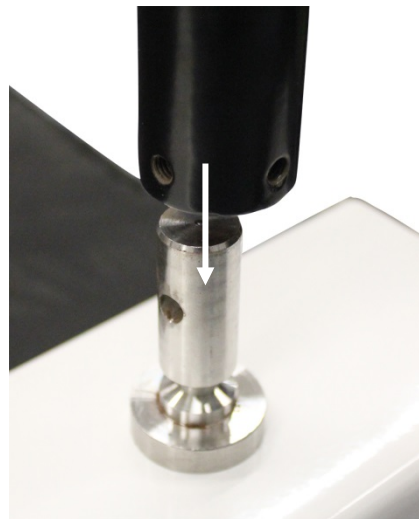

Screw down tripod at the hand rail

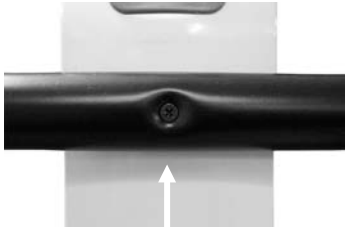

Place the side parts on the provided pins and fix them on the frame



Screw together the hand rail of the tripod with the side parts acc. to illustration

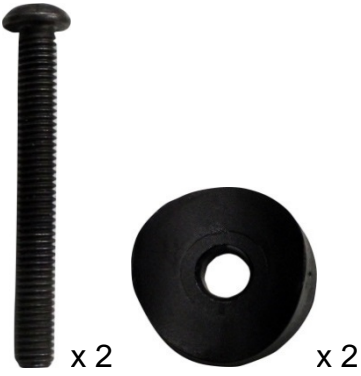

9.5 Mains connection

Power is supplied by the external power unit which also serves to isolate the mains supply from the scale. The stated voltage value must be the same as the local voltage.

It is necessary to apply only admitted original power supply adaptors of KERN company.

The small sticker attached to the side of the display unit indicates the power port:



The LED remains illuminated as long as the weighing scale remains connected to the mains.

The LED display informs you during loading about the loading status of the rechargeable battery.

green: Rechargeable battery completely reloaded

blue: Charging storage battery

The standard version of the balance is without rechargeable battery.

9.6 Battery operation with optional battery power pack

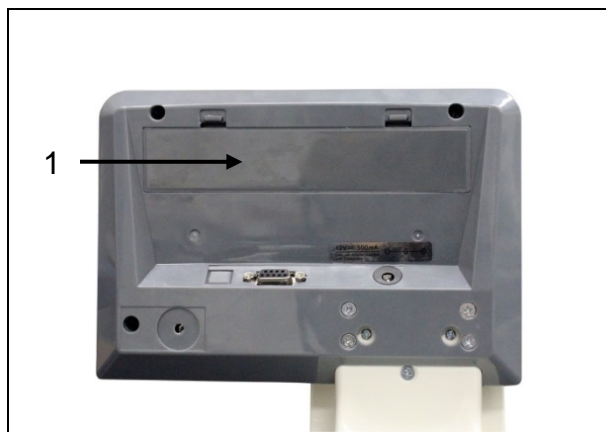

Open the battery compartment cover (1) at the base of the display unit and insert the rechargeable battery. Charge the battery for at least 12 hours before initial use.

The appearance of the symbol  in the weight display indicates that the battery is almost exhausted. The weighing scale will remain ready for operation for a few more minutes before switching off in order to save battery. Load rechargeable battery.

 Voltage has dropped below prescribed minimum.

 Rechargeable battery very low.

 Rechargeable battery completely reloaded

Prior to starting-up the balance, load the rechargeable battery completely.

Right underneath the display there is a LED with the symbol .

If the LED lights green, the rechargeable battery is fully charged. If it is lighting blue, it will be loaded.

If the balance is not used for a longer time, take out the rechargeable battery and store it separately. Leaking liquid could damage the balance.

9.7 Battery operation

Alternatively to the rechargeable battery operation, the balance may also be operated with 6x AA batteries.





Open battery compartment cover (1) at the base of the display unit and insert batteries from below according to example. Relock the battery cover. If the batteries are empty, the symbol  appears in the balance display. Replace the batteries. To save the battery, the balance will switch off automatically (see chap.11.6 Auto off).

 Capacity of batteries exhausted.

 Batteries will soon be flat.

 Batteries are completely loaded

9.8 Insert batteries/rechargeable batteries on the example of batteries:

| | |
|---|--|
| Remove the battery compartment cover |  |
| Connect battery holder acc. to illustration to the contact of the casing |  |
| Insert battery holder |  |
| Insert batteries in the battery compartment, close and lock with battery compartment cover. |  |

9.9 Initial Commissioning

In order to obtain exact results with the electronic balances, your balance must have reached the operating temperature (see warming up time chap.1). During this warming up time the balance must be connected to the power supply (mains, accumulator or battery) and be switched on.

The accuracy of the balance depends on the local acceleration of gravity.
The value of gravity acceleration is shown on the type plate.

10 Operation

10.1 Weighing



- ⇒ Start balance by pressing .
The balance will carry out a self-test
The scales are ready for operation as soon as the weight display for "0.0 kg" has appeared.



- However, you can reset the weighing scale to zero by pressing the  key.

- ⇒ Have person stand in the centre of the scales. Wait until the standstill display „STABLE“ appears, then read the weighing result.



- If the person is heavier than the weighing range, "OL" (=overload) will appear in the display.

10.2 Taring

The tare weight of any preloads can be deducted by pressing a button so that the actual weight of the person is displayed in subsequent weighings.

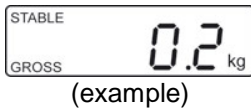

⇒ Put object (such as towel or padding) on the weighing pan.



⇒ Press , the zero display appears. „NET” is shown at the bottom on the left.

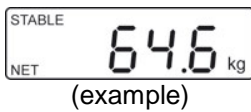

⇒ Allow the person to step onto the centre of the weighing platform.
Wait until the standstill display „STABLE“ appears, then read the weighing result.



- When the balance is unloaded the saved taring value is displayed with negative sign.
- To delete the stored tare value, release scales and press .

10.2.1 Subsequent tare weight

The balance can be tared several times successively. This function can be enabled or disabled. For that make in the menu the following setting:



- Menu setting:
[F5 Str] ⇒ [Str on] (see chap. 12)

10.3 HOLD function

The balance has an integrated standstill function (mean value calculation). With this function it is possible to weigh people accurately even if they do not stand still on the weighing plate.



- ⇒ Start balance by pressing .
Wait for stability display „STABLE“ to appear.

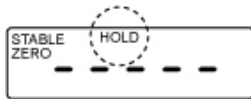

- ⇒ Press , in the display „-----“ will appear and the „HOLD“ symbol appears.

- ⇒ Allow the person to step onto the centre of the weighing platform.



(example)

- ⇒ After a short time the stability display „STABLE“ appears and the weighing value of the person is displayed and „frozen“.

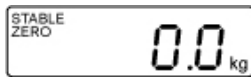

After unloading the balance, the weighing value remains displayed for approx. 10 seconds, than the balance changes automatically into the weighing mode.
The „HOLD“ symbol disappears.



There is no average value calculation in the event of too much movement.

10.4 Display additional decimal point

(short-time additional decimal point)

Press  and hold for about 2 s whilst weighed result is being shown. The second decimal place will be shown for approx. 5 s.

10.5 Calculation of the Body Mass Index

You need to know a person's body height before you can calculate the BMI for that person. This should be known.

10.5.1 Calculating Body Mass Index



⇒ Start balance by pressing 

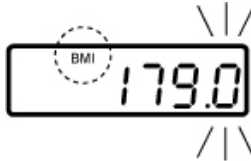

⇒ Wait for stability display „STABLE“ to appear.

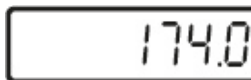

⇒ Press 

The most recently entered body height will be shown with the enable digit flashing. The „BMI“ symbol lights up.



⇒ To enter body height, press the  and  key.



⇒ Confirm the value entered by . BMI „0.0“ is displayed

⇒ Allow the person to step onto the centre of the weighing platform.



„-----“, is shortly displayed, followed by the BMI value of the person.

⇒ Unload weighing plate

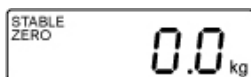

⇒ Return to weighing mode using 

The BMI symbol will disappear and the kg display will reappear.



- Reliable calculation of BMI is restricted to a body height of 100 cm to 200 cm and a weight of >10 kg.
- If weighing has to take place under unsteady conditions, you can stabilise the display by applying the Hold function.

10.5.2 Classification of BMI values

Weight classification for adults over 18 years of age using the BMI in accordance with WHO, 2000 EK IV and WHO 2004.

| Categorie | BMI (kg/m²) | Risk of diseases associated with overweight |
|--------------------|--------------------------------|--|
| Underweight | < 18.5 | low |
| Normal weight | 18.5 – 24.9 | Average |
| Overweight | \geq 25.0 | |
| Pre-adipose | 25.0 – 29.9 | A bit high |
| Adipose degree I | 30.0 – 34.9 | Increased |
| Adipose degree II | 35.0 – 39.9 | High |
| Adipose degree III | \geq 40 | Very high |

10.6 Automatic switch-off function „AUTO OFF“

The weighing scale will switch off automatically after the allotted time as long as neither the display unit nor the weighing plate is operated.



- Menu settings:
[F1 oFF] ⇒ **[oFF 0/3/5/15/30]** (see chap. 12)

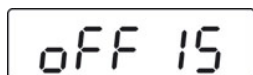

(example)

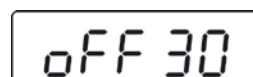

(example)

⇒ In weighing mode, press and the first function **[F1 oFF]** will be displayed.

⇒ Press , the last saved time is displayed, for example, **[oFF 15]**

⇒ Press repeatedly until the desired time is displayed, e.g. **[oFF 30]**

| | |
|-----------------|--|
| [oFF 0] | AUTO OFF - function disabled |
| [oFF 3] | Weighing system will be turned off after 3 min. |
| [oFF 5] | Weighing system will be turned off after 5 min. |
| [oFF 15] | Weighing system will be turned off after 15 min. |
| [oFF 30] | Weighing system will be turned off after 30 min. |

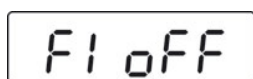

⇒ Save selected time with , **[F1 oFF]** is displayed



⇒ Return to weighing mode using

10.7 Display background illumination



- Menu settings:
[F4 bk] ⇒ [bL on / bL oFF / bL AU] see chap. (12)

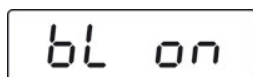
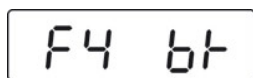
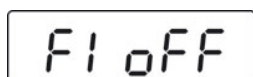

(example)



⇒ In weighing mode, press and the first function [F1 oFF] will be displayed.

⇒ Press repeatedly until [F4 bk] is shown.

⇒ Press , the last saved setting is displayed, for example [bL on]

⇒ To select the desired setting, press

bL on

Continuous background lighting

bL off

Background illumination off

bL Auto

Automatic background illumination on when weighing pate is loaded or key pressed.

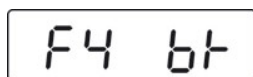







⇒ With save select setting, [F4 bk] is displayed.



⇒ Return to weighing mode using





11 Menu





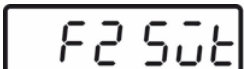
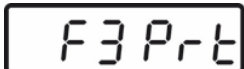



11.1 Navigation in the menu

| | |
|---|---|
| Call up menu | ⇒ In weighing mode, press  and the first function [F1 OFF] will be displayed. |
| Select function | ⇒ With help of  , the individual functions can be selected one after the other. |
| Change settings | ⇒ Confirm selected function by  . The current setting will be displayed. ⇒ Select desired setting by  and confirm with  , the balance returns to the menu. |
| Exit menu/ Return to weighing mode | ⇒ Press  , the balance will return to weighing mode. |

English

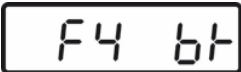
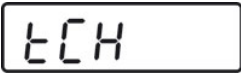
11.2 Menu overview

| Menu block Main menu | Menu item Submenu | Available settings / explanation |
|---|--|--|
|  Automatic cutout Auto Off | oFF 0* | Automatic shutdown off |
| | oFF 3 | Automatic shutdown after 3 min |
| | oFF 5 | Automatic shutdown after 5 min |
| | oFF 15 | Automatic shutdown after 15 min |
| | oFF 30 | Automatic shutdown after 30 min |
|  | oFF* | Not documented |
| | Prt | |
| | Pr ACC | |
|  Interface parameter | 1. RS-232 mode | |
| | Select desired mode by  , then confirm with  . | |
| | P Prt | Weight will be added to summation memory and printed after pressing PRINT |
| | P Cont | Continuous data output |
| | Series | Not documented |
| | ASK | Remote control instructions: W: Send all weighing details S: Send stable weight value T: Taring Z: Zeroing |
| | P cnt 2 | Not documented |
| | P Stab | Automatic data output of stable weighing values |
| | P Auto | Weighed result will be added automatically to summation memory and issued |
| | 2. Baud rate | |
| The currently set baud rate (b xxx) will be shown after the RS-232 mode was confirmed. Select desired Baudrate by  and confirm by pressing  . | | |
| Available Baud rate: 600, 1200, 2400, 4800, 9600 | | |

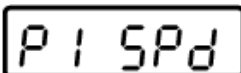
| | | | |
|--|---------|--|---|
| | | <p>3. Data output format (P Prt, P Auto, P Cont settings only) the currently set data output format will be shown after the baud rate was confirmed. Select desired format by  and confirm with .</p> | |
| Only with setting P Prt, P | Prt 0-3 | Data output format, see chap. 13.3 | |
| Only when set P Cont | Cont 1 | Default | Sd0 – on/off Continuous data output, selectable „sending 0“, yes / no |
| | Cont 2 | Not documented | |
| | Cont 3 | Not documented | |
| <p>4. Printer type</p> <p>After the data output format has been confirmed, the currently set printer type will be displayed.</p> <p>Select the desired printer type by  and confirm by .</p> <p>LP -50 Not documented tPUP Use this setting</p> | | | |
|  Background illumination of display | bl on | Back lighting for display on | |
| | bl oFF | Display background illumination off | |
| | bl AU* | Backlighting for display will come on automatically as soon as the weighing scale is operated. | |
|  Service menu | Pin | Password Input: Press  ,  ,  | |
| Operate adjustment switch; for position see chap.17 | | | |
|  Display speed | 15* | Not documented | |
| | 30 | | |
| | 60 | | |
| | 7.5 | | |

| | | |
|--------|--------------------------|---|
| P2 CAL | Adjustment, see chap. 17 | |
| | | |
| P3 Pro | tri* | Not documented |
| | CoUnt | Not documented |
| | rESEt | Reset weighing scale to factory setting |
| | SEtGrA | Not documented |

* default setting

12 Data output RS 232

You can print weighing data automatically via the RS 232 interface or manually by pressing  via the interface according to the setting in the menu.

This data exchange is asynchronous using ASCII - Code.

The following conditions must be met to provide successful communication between the weighing balance and the printer.

- Use a suitable cable to connect the weighing balance to the interface of the printer. Faultless operation requires an adequate KERN interface cable.
- Communication parameters (baud rate, bits and parity) of balance and printer must match. For detailed description of interface parameters see chap. 13.2)

12.1 Pin allocation of balance output bushing:

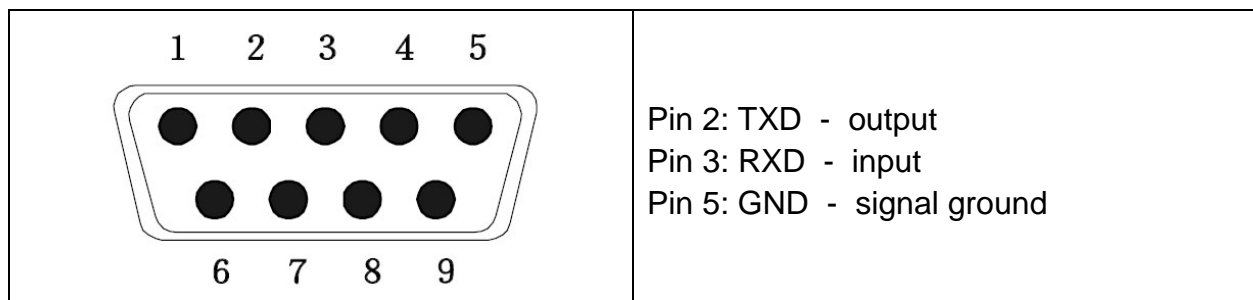

12.2 Technical data

| | |
|------------|---|
| Connection | 9 pin d-subminiature bushing Pin 2 output Pin 3 input Pin 5 signal earth |
| Baud rate | Optional 600/1200/2400/4800/9600 |
| Parity | 8 bits |

12.3 Printer operation

Printout examples:

| | |
|--------------|------------------------------|
| Prt | |
| 0 / 2 | 60.0kg |
| 1 / 3 | 60.0kg 170.0cm 20.7BMI |

Remote control instructions:

| | | | | |
|------------|-----------|----|----------|-----------------------|
| S: | | | | |
| 29.03.2017 | 09:31:21: | ST | 20.0 kg | Stable positive value |
| 29.03.2017 | 09:31:55: | ST | -20.0 kg | Stable negative value |

| | | | | |
|------------|-----------|----|----------|-------------------------|
| W: | | | | |
| 29.03.2017 | 09:32:12: | US | 44.3 kg | Instable positive value |
| 29.03.2017 | 09:32:38: | US | -18.4 kg | Instable negative value |

13 Error messages

Display

Description



Zero range exceeded

(on start-up or when pressing the  key)

- Load on weighing pan
- Excess load, during zero setting of weighing scale
- Incorrect adjusting process
- Fault on load cell

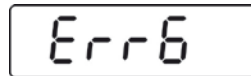

Value outside the A/D converter range

- Damaged weighing cell
- Damaged electronics



Lack of possibility of zero point initiation

- Damaged / overloaded measuring cell
- The objects are located on the platform / have contact with it
- Unremoved transportation protection
- Main Board damaged

Should other error messages occur, switch balance off and then on again. If the error message remains inform manufacturer.

14 Servicing, maintenance, disposal

14.1 Cleaning



Before any maintenance, cleaning and repair work disconnect the appliance from the operating voltage.

14.2 Cleaning / Disinfecting

Clean weighing platform (such as seat) as well as casing with household detergents or commercially available disinfectants, e.g. 70% isopropanol. We recommend a disinfectant suitable for wiping disinfection. Please follow manufacturer's instructions.

Do not use abrasive or aggressive cleaners such as spirits or alcohol or similar as they might damage the high-quality surface.

To prevent cross-contamination (fungal skin infection) please observe the following time intervals for disinfection:

- Weighing plate before and after any measurement with direct skin contact
- When required:
 - Display
 - Touch-sensitive keyboard



Do not spray disinfectants onto appliance.

Make sure that disinfectant does not penetrate the interior of the balance.

Remove dirt immediately.

14.3 Sterilisation

Sterilisation of the appliance is not allowed.

14.4 Servicing, maintenance

The appliance may only be opened by trained service technicians who are authorized by KERN.

Disconnect the scales before opening.

14.5 Disposal

Disposal of packaging and appliance must be carried out by operator according to valid national or regional law of the location where the appliance is used.

15 Instant help

In case of an error in the program process, briefly turn off the balance and disconnect from power supply. The weighing process must then be restarted from the beginning.

Fault

Possible cause

The displayed weight does not glow.

- The balance is not switched on.
- The mains supply connection has been interrupted (mains cable not plugged in/faulty).
- Power supply interrupted.
- Rechargeable battery inserted incorrectly or empty
- No rechargeable battery inserted

The displayed weight is permanently changing

- Draught/air movement
- Table/floor vibrations
- The weighing plate is in contact with foreign bodies or is not correctly positioned.
- Electromagnetic fields / static charging (choose different location/switch off interfering device if possible)

The weighing result is obviously incorrect

- The display of the balance is not at zero
- Adjustment is no longer correct.
- Great fluctuations in temperature.
- Warm-up time was ignored.
- Electromagnetic fields / static charging (choose different location/switch off interfering device if possible)

Should other error messages occur, switch balance off and then on again. If the error message remains, inform manufacturer.

Position adjustment switch and seals

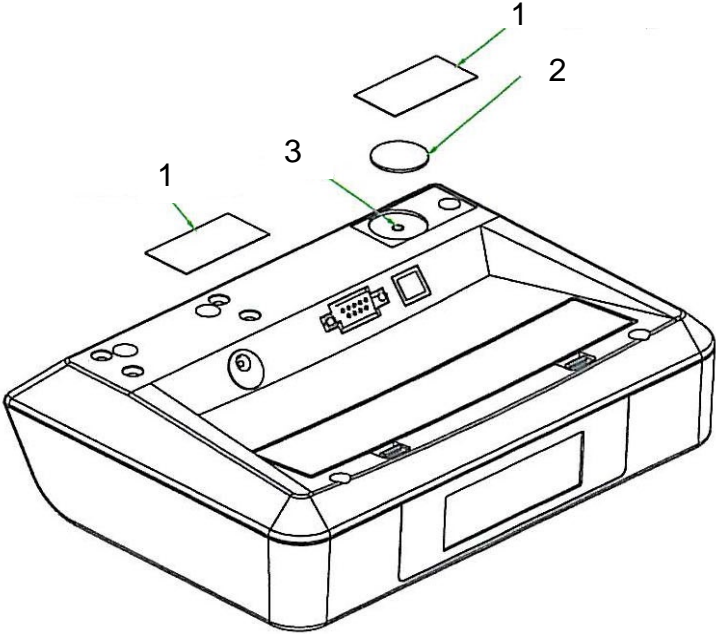

- 1. Self-destroying seal mark
- 2. Cover
- 3. Adjustment switch

16 Adjustment















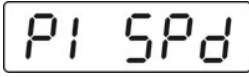
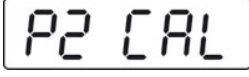





As the acceleration value due to gravity is not the same at every location on earth, each display unit with connected weighing plate must be coordinated - in compliance with the underlying physical weighing principle - to the existing acceleration due to gravity at its place of location (only if the weighing system has not already been adjusted to the location in the factory). This adjustment process must be carried out for the first commissioning, after each change of location as well as in case of fluctuating environment temperature. To receive accurate measuring values it is also recommended to adjust the display unit periodically in weighing operation.

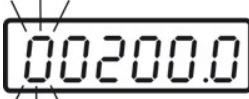

- Prepare the required adjustment weight. The adjustment weight to be applied depends on the capacity of a weighing scale, see chap. 1. Carry out adjustment as closely as possible to admissible maximum load of weighing scale. Info about test weights can be found on the Internet at: <http://www.kern-sohn.com>.
- Observe stable environmental conditions.
For warm-up time required for stabilisation see chap. 1.

Procedure:

| | |
|--|---|
| | <p>⇒ In weighing mode, press repeatedly until [tCH] appears.</p> |
| | <p>⇒ Press , [Pin] is displayed</p> |

| | |
|---|--|
|  | <p>⇒ Press ,  and  one after the other, [P1 SPd] will appear</p> |
|  <p style="text-align: center;">↓</p>   | <p>⇒ Press , „P2 CAL“ will be displayed</p> <p>⇒ Operate adjustment switch; for position see chap.17</p> <p>⇒ Press , [duA rA] or [SnG rA] will be displayed</p> <p>⇒ Select [duA rA] and acknowledge with , [dESC] will be displayed</p> |
|  | <p>⇒ Press , [dESC] is displayed</p> |
|  | <p>⇒ Press  repeatedly until [CAL] will be displayed.</p> <p>⇒ Confirm with , [UnLoAd] appears</p> |
|  | <p>⇒ Ensure that there are no objects on the weighing pan.</p> <p>⇒ Wait for stability display "STABLE", then confirm with </p> |
|  <p>(example)</p> | <p>⇒ The size of the currently set adjustment weight will be displayed.</p> <p>To change, select the digit to be altered by , and the numerical value by .</p> <p>⇒ Confirm with , [LoAd] appears.</p> |

LoAd



PASS

STABLE
ZERO
GROSS 0.0 kg

- ⇒ Place adjustment weight in the centre of the weighing pan
- ⇒ Wait until stability display „STABLE“ appears
- ⇒ Confirm with  [PASS] is displayed.
- ⇒ The balance carries out a selftest, after that [Err19] will be displayed and a signal will sound.
- ⇒ Switch off the balance
- ⇒ Take away adjustment weight
- ⇒ Switch balance on again, after the selftest the balance will change to weighing mode. Adjustment has now been completed successfully.