



KERN & Sohn GmbH

Ziegelei 1
D-72336 Balingen
E-Mail: info@kern-sohn.com

Phone: +49-[0]7433- 9933-0
Fax: +49-[0]7433-9933-149
Internet: www.kern-sohn.com

Operating manual Multi-function weighing balance

KERN MWA

Type MWA_NM
Type MWA_PNM
Version 1.1
2017-12
GB



MWA-BAPS-e-1711



KERN MWA
Version 1.1 2017-12
Operating manual
Multi-function weighing balance

Contents

1	Technical data	4
2	Declaration of conformity	5
3	Appliance overview	5
4	Keyboard overview	8
5	Overview of display	9
6	Basic instructions	10
6.1	Proper use	10
6.2	Improper Use	10
6.3	Warranty	11
6.4	Monitoring of Test Resources	11
7	Basic Safety Precautions	11
7.1	Pay attention to the instructions in the Operation Manual.....	11
9	Transport and storage	12
9.1	Testing upon acceptance	12
9.2	Packaging / return transport.....	12
10	Unpacking, Setup and Commissioning	13
10.1	Installation Site, Location of Use	13
10.2	Unpacking	13
10.3	Scope of delivery	14
10.4	Balance assembly and installation	14
10.4.1	Application examples:	14
10.5	Mains connection	15
10.6	Battery operation is possible by obtaining an optional battery power pack	16
10.7	Battery operation.....	17
10.8	Inserting an accumulator/battery, exemplified by a battery set:	17
10.9	Initial Commissioning	18
11	Operation	18
11.1	Weighing.....	18
11.1.1	Weighing with wheelchair.....	19
11.2	Taring	19
11.3	HOLD function	20
11.4	Display additional last decimal place.....	21
11.5	Calculation of the Body Mass Index	21
11.5.1	Calculating Body Mass Index.....	21
11.5.2	Classification of BMI values	22
11.6	Automatic switch-off function „AUTO OFF“	23
11.7	Display background illumination.....	24
12	Menu	25
12.1	Navigation in the menu	25

12.2	Menu overview.....	26
13	Data output RS 232	28
13.1	Pin allocation of balance output bushing:	28
13.2	Technical data	28
13.3	Printer operation	29
14	Error messages	29
15	Servicing, maintenance, disposal.....	30
15.1	Cleaning	30
15.2	Cleaning/Disinfection	30
15.3	Sterilisation	30
15.4	Servicing, maintenance.....	30
15.5	Disposal.....	30
16	Instant help	31
17	Adjustment	33

1 Technical data

KERN	MWA 300K1NM	MWA 300K1PNM
Trademark	MWA 300K1M	MWA 300K1PM
Display	6-digit	
Weighing range (max)	300 kg	
Reproducibility	0.1 kg	
Linearity ±	0.1 kg	
Display	LCD with 25mm high digits	
Recommended adjustment weight, (Class)	300 kg (M1)	
Stabilization time (typical)	2 sec.	
Warm-up time	10 min	
Operating temperature	10° C + 40° C	
Humidity of air	max. 80 % (not condensing)	
Electric Supply	Input voltage 100V-240V AC, 50 / 60 Hz	
Auto Off	After 3, 5, 15, 30 min without load change (adjustable)	
Dimensions fully assembled (D x W X H) mm	1190 x 1140 x 80	1190 x 1140 x 1150
Weighing plate (W x D) mm	840 x 880	
Weight kg (net)	72	76
Rechargeable battery operation	Optional	
Batteries	6 x 1.5 V AA	
Data interface provided as standard	RS 232 C	

2 Declaration of conformity

To view the current EC/EU Declaration of Conformity go to:

www.kern-sohn.com/ce

3 Appliance overview

 <p>The wheelchair platform scale MWA-M with folded and unfolded ramps and the display (serial fitting).</p>	 <p>The wheelchair platform scale MWA-PM with folded and unfolded ramps, the display and the rail with a stand (serial fitting). The possibility of retrofitting with 2nd rail MWA-A02 (without a stand).</p>
	<p>Folded wheelchair platform scale MWA-PM.</p>

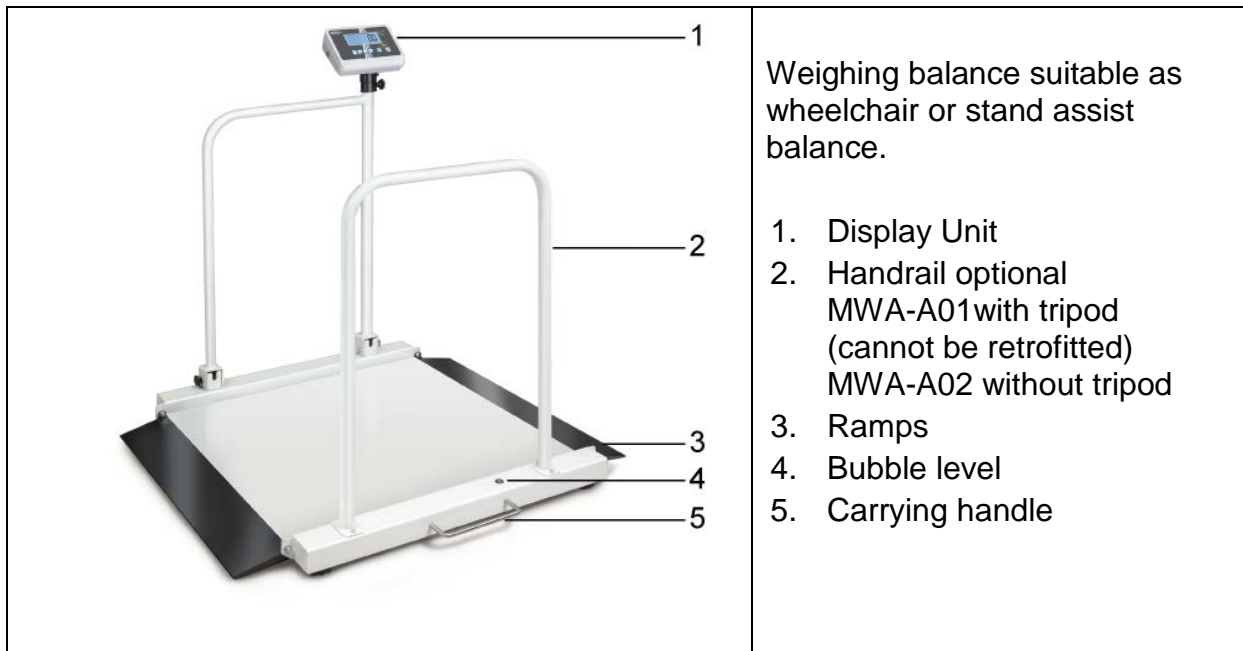

<p>Wheelchair balance (Collapsible ramps)</p>	<p>Suitable as wheelchair and stand assist balance</p>	<p>Handrail collapsible</p>





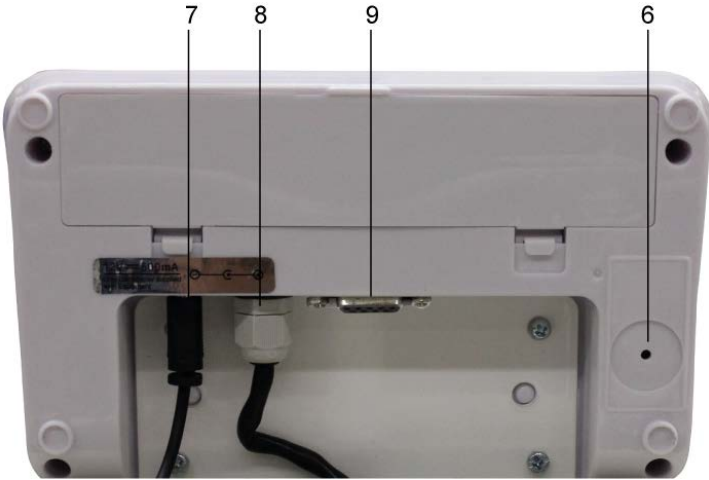

Assembly of the rail:

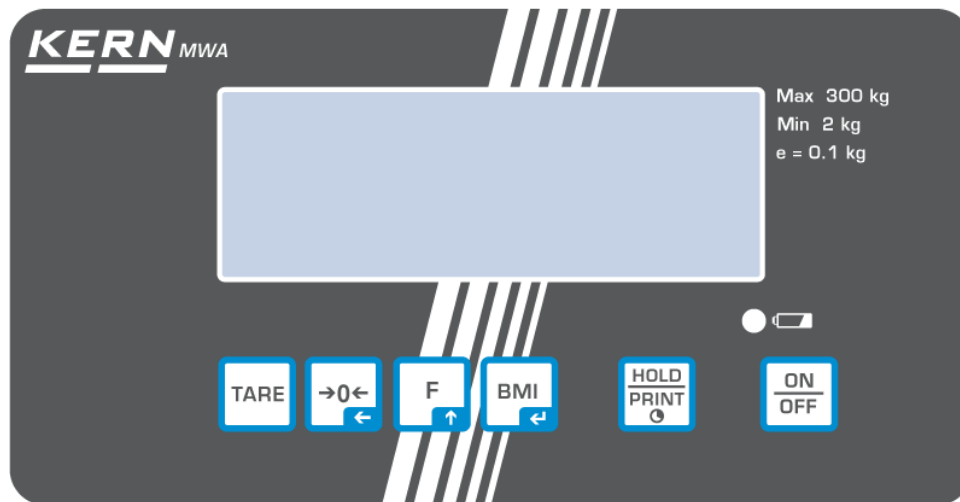
	<p>Carefully mount the rail and fasten it with screws. The activity should preferably be performed by two people.</p>
---	---







<p>Display unit back</p> 	<ul style="list-style-type: none">6. Adjustment switch7. Terminal power supply unit8. Connecting cable "display unit - platform"9. Connector RS232
---	---

4 Keyboard overview



Button	Designation	Function
	ON/OFF button	Turn on/off
	Hold-key Print-key	Hold function /determination of stable weighing value Print (press and hold for a while): Data transmission via interface RS 232
	BMI key	Determination of body mass index In the menu: <ul style="list-style-type: none"> • Confirm selection For numeric entry: <ul style="list-style-type: none"> • Confirm numerical value
	Function key	In menu: <ul style="list-style-type: none"> • Call up menu • Select menu items For numeric entry: <ul style="list-style-type: none"> • Increase numerical value
	Zeroing key	Weighing scale will be reset to „0.0“ For numeric entry: <ul style="list-style-type: none"> • Change decimal place
	TARE key	Tare balance

5 Overview of display

Display	Designation	Description
	Stability display	Scales are in a steady state
	Zeroing display	Should the balance not display exactly zero despite empty weighing plate, press the  button. Your balance will be set to zero after a short standby time.
NET	Net weight display	Illuminated when net weight is displayed Illuminated after weighing scale was tared
GROSS	Gross weight display	Illuminated when gross weight is displayed
HOLD	HOLD function	HOLD function active
BMI	BMI function	Illuminated while BMI function is enabled
  	Rechargeable /Battery display	Shows the capacity of the rechargeable / batteries

6 Basic instructions

6.1 Proper use

The balance is intended for determining the weight of persons in standing and sitting positions.

In the case of multifunctional balances, the weighted person should be carefully positioned in the centre of the weighing plate and stand still. If a wheelchair is used, it should be positioned in the centre of the weighing plate.

The weight can be read after the balance is stabilised.
The balance is designed for continuous operation.



The weighing platform may only be stepped on by persons capable of standing on both feet on the weighing platform.

6.2 Improper Use

Do not use these scales for dynamic weighing processes.

Do not leave permanent load on the weighing pan. This may damage the measuring system.

Impacts and overloading exceeding the stated maximum load (max) of the weighing plate, minus a possibly existing tare load, must be strictly avoided. This could cause damage to the balance.

Never operate balance in explosive environment. The serial version is not explosion protected. It should be noted that a flammable mixture of anaesthetics and oxygen or laughing gas may occur.

The structure of the balance may not be modified. This may lead to incorrect weighing results, safety-related faults and destruction of the balance.

The balance may only be used according to the described conditions. Other areas of use must be released by KERN in writing.

Do not use the balance to determine body weight in medicine.

6.3 Warranty

Warranty claims shall be voided in case



- Our conditions in the operation manual are ignored
- The appliance is used outside the described uses
- The appliance is modified or opened
- Mechanical damage and damage caused by media, liquids,
- Natural wear and tear
- The appliance is improperly set up or incorrectly electrically connected
- The measuring system is overloaded
- Dropping the balance

6.4 Monitoring of Test Resources

In the framework of quality assurance the measuring-related weighing properties of the balance and, if applicable, the testing weight, must be checked regularly. The responsible user must define a suitable interval as well as type and scope of this test. Information is available on KERN's home page (www.kern-sohn.com) with regard to the monitoring of balance test substances and the test weights required for this. In KERN's accredited DKD calibration laboratory test weights and balances may be calibrated (return to the national standard) fast and at moderate cost.

7 Basic Safety Precautions

7.1 Pay attention to the instructions in the Operation Manual

	<p>Carefully read this operation manual before setup and commissioning, even if you are already familiar with KERN balances.</p>	
---	--	---

9 Transport and storage

9.1 Testing upon acceptance

When receiving the appliance, please check packaging immediately, and the appliance itself when unpacking for possible visible damage.

9.2 Packaging / return transport



- ⇒ Keep all parts of the original packaging for a possibly required return.
- ⇒ Only use original packaging for returning.
- ⇒ Prior to dispatch disconnect all cables and remove loose/mobile parts.
- ⇒ Reattach possibly supplied transport securing devices.
- ⇒ Secure all parts such as the weighing platform, power unit etc. against shifting and damage.

10 Unpacking, Setup and Commissioning

10.1 Installation Site, Location of Use

The balances are designed in a way that reliable weighing results are achieved in common conditions of use.

You will work accurately and fast, if you select the right location for your balance.

On the installation site observe the following:

- Place scales on a stable, even surface;
- Avoid extreme heat as well as temperature fluctuation caused by installing next to a radiator or in the direct sunlight;
- Protect the balance against direct draughts due to open windows and doors;
- Avoid jarring during weighing;
- Protect the balance against high humidity, vapours and dust;
- Do not expose the device to extreme dampness for longer periods of time. Non-permitted condensation (condensation of air humidity on the appliance) may occur if a cold appliance is taken to a considerably warmer environment. In this case, acclimatize the disconnected appliance for ca. 2 hours at room temperature.
- Avoid static charge of the balance and of the person to be weighed.
- Avoid contact with water.

Major display deviations (incorrect weighing results) may be experienced should electromagnetic fields (e.g. due to mobile phones or radio equipment), static electricity accumulations or instable power supply occur. Change location or remove source of interference.



10.2 Unpacking

Remove the individual components of the balance or the complete balance from the packaging with care and install at the intended location. When using the power pack, ensure that the power cable does not produce a risk of stumbling.

10.3 Scope of delivery

Serial accessories:

- Balance
- Mains adapter
- Operating manual
- Wall bracket
- Small components

	
4 x	2 x

10.4 Balance assembly and installation

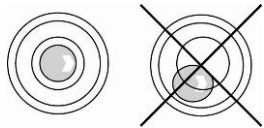



⇒ Level balance with foot screws until the air bubble of the water balance is in the prescribed circle.

⇒ Check levelling regularly.

The weighing balance to be used as wheelchair balance is delivered fully assembled. 1 handrail with tripod (MWA-A01) or 1 handrail without tripod (MWAS-A02) are optionally available for additional use as stand assist balance (See chap.3 device overview). The handrails are also suitable for use in connection with wheelchairs.

10.4.1 Application examples:

Weighing balance used as	
Wheelchair balance	stand assist balance with handrail MWS-A01
	

Assembly handrail MWA-A02 (optional):

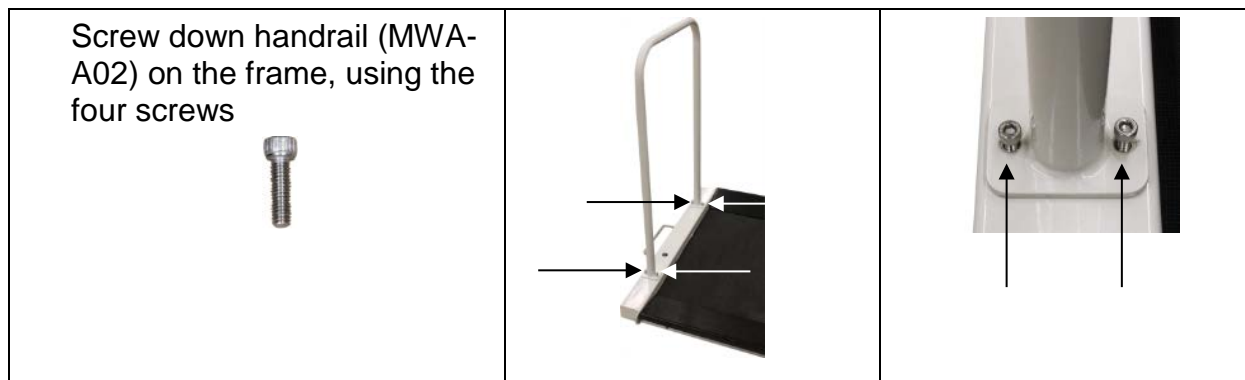

After fitting the attachments and before using the weighing balance, check all attachments for firm fit.

10.5 Mains connection

Power is supplied by the external power unit which also serves to isolate the mains supply from the scale. The stated voltage value must be the same as the local voltage.

Use only approved original KERN power units.

The LED remains illuminated as long as the weighing scale remains connected to the mains.

The LED display informs you during loading about the loading status of the rechargeable battery.

green: Rechargeable battery completely reloaded

blue: Charging storage battery

10.6 Battery operation is possible by obtaining an optional battery power pack



Open the battery compartment cover (1) at the base of the display unit and insert the rechargeable battery. Charge the battery for at least 12 hours before initial use.

The appearance of the symbol  in the weight display indicates that the battery is almost exhausted. The weighing scale will remain ready for operation for a few more minutes before switching off in order to save battery. Load rechargeable battery.

 Voltage has dropped below prescribed minimum.

 Rechargeable battery very low.

 Rechargeable battery completely reloaded

Right underneath the display there is a LED with the symbol .



If the LED lights green, the rechargeable battery is fully charged. If it is lighting blue, it is being charged.

If the balance is not used for a longer time, take out the rechargeable battery and store it separately. Leaking liquid could damage the balance.



10.7 Battery operation

As an alternative to rechargeable battery operation, the balance may also be operated with 6x AA batteries.

Open battery compartment cover (1) at the lower side of the display unit and insert batteries according to the example below. Lock the battery cover again. If the batteries are empty, in the balance display appears the symbol . Change batteries. To save battery power, the balance switches off automatically (see chap.11.6 Auto off).

-  Capacity of batteries exhausted.
-  Batteries will soon be flat.
-  Batteries are completely charged

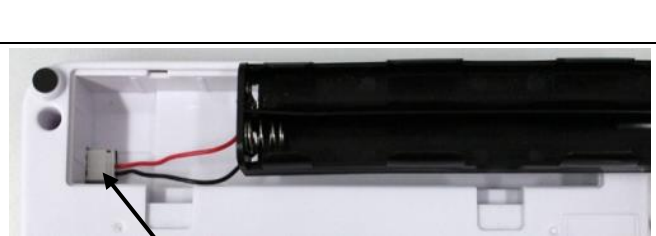
10.8 Inserting an accumulator/battery, exemplified by a battery set:

Remove battery compartment cover	
Connect battery holder to housing contact acc. to illustration	
Insert battery holder	
Insert batteries into battery compartment and lock with battery compartment cover.	

10.9 Initial Commissioning

In order to obtain exact results with the electronic balances, your balance must have reached the operating temperature (see warming up time chap. During this warming up time the balance must be connected to the power supply (mains, accumulator or battery) and be switched on.

The accuracy of the balance depends on the local acceleration of gravity.
The value of gravity acceleration is shown on the type plate.

11 Operation

11.1 Weighing



- ⇒ Start balance by pressing .
The balance will carry out a self-test
The scales are ready for operation as soon as the weight display for "0.0 kg" has appeared.



- However, you can reset the weighing scale to zero by pressing the  key.

- ⇒ Have person stand in the centre of the scales. Wait until the standstill display „STABLE“ appears, then read the weighing result.



- If the person is heavier than the weighing range, "OL" (=overload) will appear in the display.

11.1.1 Weighing with wheelchair

- ⇒ Place wheelchair and patient in the centre of the weighing balance.
- ⇒ Engage brakes on wheelchair



Do not leave the patient unattended

- ⇒ Wait until patient is sitting still and read weighing value 1.
- ⇒ Loosen the brakes and carefully pull off the transportation stretcher/wheelchair with patient
- ⇒ Then weigh the wheelchair without the patient and deduct the result from weighing value 1, from this follows the weight for the patient.

11.2 Taring

The tare weight of any preloads can be deducted by pressing a button so that the actual weight of the person is displayed in subsequent weighings.

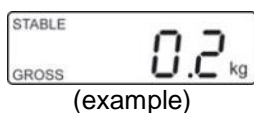

- ⇒ Put an object (such as a towel, support or empty wheelchair) on the weighing pan.

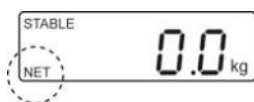

- ⇒ Press , the zero display appears. „NET” is shown at the bottom on the left.

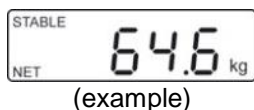

- ⇒ Allow the person to step onto the centre of the weighing platform.
Wait until the standstill display „STABLE“ appears, then read the weighing result.



- When the balance is unloaded the saved taring value is displayed with negative sign.
- To delete the stored tare value, release scales and press 

11.3 HOLD function

The balance has an integrated standstill function (mean value calculation). With this function it is possible to weigh people accurately even if they do not stand still on the weighing plate.

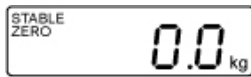

- ⇒ Start balance by pressing .
Wait for stability display „STABLE“ to appear.

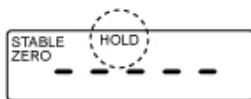

- ⇒ Press , in the display „-----“ will appear and the „HOLD“ symbol appears.

- ⇒ Allow the person to step onto the centre of the weighing platform.

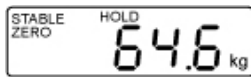

(example)

- ⇒ After a short time the stability display „STABLE“ appears and the weighing value of the person is displayed and „frozen“.

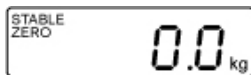

After unloading the balance, the weighing value remains displayed for approx. 10 seconds, than the balance changes automatically into the weighing mode.
The „HOLD“ symbol disappears.



There is no average value calculation in the event of too much movement.

11.4 Display additional last decimal place

(short-time, additional decimal place)











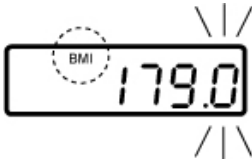

Press  and hold for about 2 s whilst weighed result is being shown. The second decimal place will be shown for approx. 5 s.

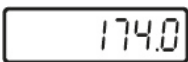
This value is not considered as verified and may not be used for the purpose of a verified balance.

11.5 Calculation of the Body Mass Index

You need to know a person's body height before you can calculate the BMI for that person. This should be known.

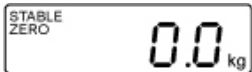
11.5.1 Calculating Body Mass Index

-  ⇒ Start balance by pressing 
- ⇒ Wait for stability display „STABLE“ to appear.
-  ⇒ Press .
The most recently entered body height will be shown with the enable digit flashing. The BMI symbol lights up.
-  ⇒ To enter body height, press the  and  key.
-  ⇒ Confirm entered value by . BMI „0.0“ is displayed
- ⇒ Allow the person to step onto the centre of the weighing platform.
„-----“, is shortly displayed, followed by the BMI value of the person.
-  ⇒ Unload weighing plate
-  ⇒ Return to weighing mode using 
The BMI symbol will disappear and the kg display will reappear.



- Reliable calculation of BMI is restricted to a body height of 100 cm to 200 cm and a weight of >10 kg.
- If weighing has to take place under unsteady conditions, you can be stabilise the display by applying the Hold function.

11.5.2 Classification of BMI values



Weight classification for adults over 18 years of age using the BMI in accordance with WHO, 2000 EK IV and WHO 2004.



Categorie	BMI (kg/m ²)	Risk of diseases associated with overweight
Underweight	< 18.5	low
Normal weight	18.5 – 24.9	Average
Overweight	≥ 25.0	
Pre-adipose	25.0 – 29.9	A bit high
Adipose degree I	30.0 – 34.9	Increased
Adipose degree II	35.0 – 39.9	High
Adipose degree III	≥ 40	Very high

11.6 Automatic switch-off function „AUTO OFF“

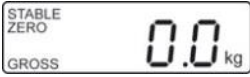

The weighing scale will switch off automatically after the allotted time as long as neither the display unit nor the weighing plate is operated.

i • Menu settings:
[F1 oFF] ⇒ **[oFF 0/3/5/15/30]** (see chap. 12)

 ⇒ In weighing mode, press  and the first function **[F1 oFF]** will be displayed.

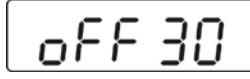

 ⇒ Press , the last saved time is displayed, for example, **[oFF 15]**

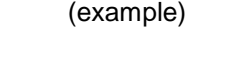

 (example)

 ⇒ Press  repeatedly until the desired time is displayed, e.g. **[oFF 30]**

 (example)

[oFF 0]	AUTO OFF - function disabled
[oFF 3]	Weighing system will be turned off after 3 min.
[oFF 5]	Weighing system will be turned off after 5 min.
[oFF 15]	Weighing system will be turned off after 15 min.
[oFF 30]	Weighing system will be turned off after 30 min.

 ⇒ Save selected time with , **[F1 oFF]** is displayed

 ⇒ Return to weighing mode using 

11.7 Display background illumination



- Menu settings:
[F2 bk] ⇒ [bL on / bL OFF / bL AU] see chap. (12)

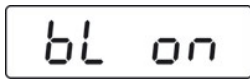
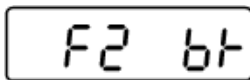

(example)



⇒ In weighing mode, press and the first function [F1 OFF] will be displayed.

⇒ Press until [F2 bk] is displayed.

⇒ Press , the last saved setting is displayed, for example [bL on]

⇒ To select the desired setting, press

bL on	Continuous background lighting
bL off	Background illumination off
bL Auto	Automatic background illumination on when weighing pate is loaded or key pressed.

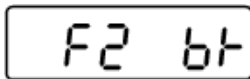







⇒ With save select setting , [F2 bk] is displayed.









⇒ Return to weighing mode using



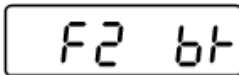
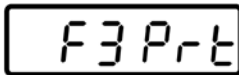





12 Menu

12.1 Navigation in the menu

Call up menu	<p>⇒ In weighing mode, press  and the first function [F1 oFF] will be displayed.</p>
Select function	<p>⇒ With help of , the individual functions can be selected one after the other.</p>
Change settings	<p>⇒ Confirm selected function by . The current setting will be displayed.</p> <p>⇒ Select desired setting by  and confirm with , the balance returns to the menu.</p>
Exit menu/ Return to weighing mode	<p>⇒ Press , the balance will return to weighing mode.</p>

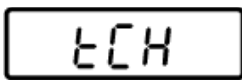
12.2 Menu overview

Function	Settings	Description
 Automatic cutout Auto Off	oFF 0*	Automatic shutdown off
	oFF 3	Automatic shutdown after 3 min.
	oFF 5	Automatic shutdown after 5 min.
	oFF 15	Automatic shutdown after 15 min.
	oFF 30	Automatic shutdown after 30 min.
 Background illumination of display	bl on	Back lighting for display on
	bl oFF	Display background illumination off
	bl AU*	Backlighting for display will come on automatically as soon as the weighing scale is operated.
 Interface parameter	1. RS-232 mode Select desired mode by  , then confirm with  .	
	P Cont	Continuous data output
	Series	Not documented
	ASK	Remote control instructions: W: Send all weighing details S: Send stable weight value T: Taring Z: Zeroing  press  for 1-2 sec.
	P cnt 2	Not documented
	P Stab	Automatic data output of stable weighing values
	P Auto	Weighed result will be added automatically to summation memory and issued
	2. Baud rate The currently set baud rate (b xxx) will be shown after the RS-232 mode was confirmed. Select desired Baudrate by pressing  and confirm by pressing  . Available Baud rate: 600, 1200, 2400, 4800, 9600	

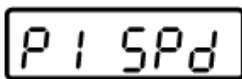
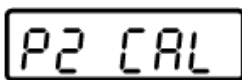
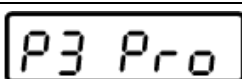
<p>3. Data output format (Setting P Prt, P Auto, P Cont only!) The currently set data output format will be displayed after the Baud rate has been confirmed. Select desired format by  and confirm with .</p>		
Only when set P Cont	Cont 1 Default Sd0 – on/off Continuous data output, selectable “Sending 0” yes / no	
	Cont 2 Not documented	
	Cont 3 Not documented	
<p>4. Printer type The currently set printer type will be displayed after the data output format has been confirmed. Select desired printer type by pressing  and confirm with .</p>		
LP 50	Not documented	
tPUP	Use this setting	
<p> Pin Password Input: press , ,  subsequently.</p> <p style="text-align: center;">Operate adjustment switch; for position see chap.15</p>		
<p> Display speed</p>	15*	Not documented
	30	
	60	
	7.5	
<p> Adjustment, see chap. 18</p>		
<p></p>	tri*	Not documented
	CoUnt	Not documented
	rESet	Reset weighing scale to factory setting
	SEtGrA	Not documented

13 Data output RS 232

You can print weighing data automatically via the RS 232 interface or manually by pressing  via the interface according to the setting in the menu.

This data exchange is asynchronous using ASCII - Code.

The following conditions must be met to provide successful communication between the weighing balance and the printer.

- Use a suitable cable to connect the weighing balance to the interface of the printer. Faultless operation requires an adequate KERN interface cable.
- Communication parameters (baud rate, bits and parity) of balance and printer must match. For detailed description of interface parameters see chap. 13.2)

13.1 Pin allocation of balance output bushing:

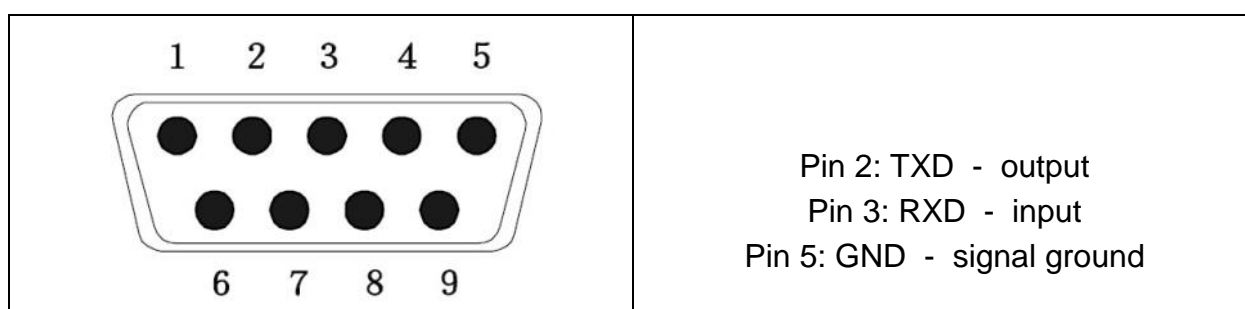

13.2 Technical data

Connection	9 pin d-subminiature bushing Pin 2 output Pin 3 input Pin 5 signal earth
Baud rate	Optional 600/1200/2400/4800/9600
Parity	no
Databits	8 bits
Stopbits	1 bit

13.3 Printer operation

Printout examples:

ST,GS	20.0kg	stable weighing value
US,GS	86.6 kg	instable weighing value

Remote control commands:

S:

29/03/2017 09:31:21: ST 20.0kg Stable positive value
 29/03/2017 09:31:51: ST - 20.0kg Stable negative value

W:

29/03/2017 09:32:25: US 44.3kg Unstable positive value
 29.03.2017 09:35:33: US - 18.4kg Unstable negative value

14 Error messages

Display

Description

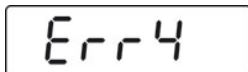

Zero range exceeded

(on start-up or when pressing the  key)

- Load on weighing pan
- Excess load, during zero setting of weighing scale
- Incorrect adjusting process
- Fault on load cell

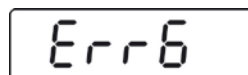

Value outside the A/D converter range

- Damaged weighing cell
- Damaged electronics

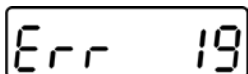

Zero point cannot be initiated

- Damaged/overloaded measuring cell
- Objects placed on / in contact with the platform
- Transport protection not removed
- Main Board defect

Should other error messages occur, switch balance off and then on again. If the error message remains inform manufacturer.

15 Servicing, maintenance, disposal

15.1 Cleaning



Before any maintenance, cleaning and repair work disconnect the appliance from the operating voltage.

15.2 Cleaning/Disinfection

The weighing plate (e.g. seat) and the casing should only be cleaned with a household cleaning agent or a commercially available disinfectant, e.g. 70% isopropyl alcohol solution. We recommend using a disinfectant intended for disinfection by wet wiping the surface. Observe the manufacturer's instructions.

Do not use any polishing or aggressive cleaning agents, such as spirit, petrol or similar, as they may damage the high-quality surface.

To avoid cross contamination (mycosis), disinfect the balance as follows:

- Weighing plate: before and after each measurement that implies direct skin contact.
- If necessary:
 - Display
 - Foil keyboard



Do not spray the device with a disinfectant.

Disinfectant may not penetrate inside the balance.

Remove any contamination immediately.

15.3 Sterilisation

Sterilising the device is not allowed.

15.4 Servicing, maintenance

The appliance may only be opened by trained service technicians who are authorized by KERN.

Disconnect the scales before opening.

15.5 Disposal

Disposal of packaging and appliance must be carried out by operator according to valid national or regional law of the location where the appliance is used.

16 Instant help

In case of an error in the program process, briefly turn off the balance and disconnect from power supply. The weighing process must then be restarted from the beginning.

Fault

Possible cause

The displayed weight does not glow.

- The balance is not switched on.
- The mains supply connection has been interrupted (mains cable not plugged in/faulty).
- Power supply interrupted.
- Rechargeable battery inserted incorrectly or empty
- No rechargeable battery inserted

The displayed weight is permanently changing

- Draught/air movement
- Table/floor vibrations
- The weighing plate is in contact with foreign bodies or is not correctly positioned.
- Electromagnetic fields / static charging (choose different location/switch off interfering device if possible)

The weighing result is obviously incorrect

- The display of the balance is not at zero
- Adjustment is no longer correct.
- Great fluctuations in temperature.
- Warm-up time was ignored.
- Electromagnetic fields / static charging (choose different location/switch off interfering device if possible)

Should other error messages occur, switch balance off and then on again. If the error message remains inform manufacturer.

Position adjustment switch and seals

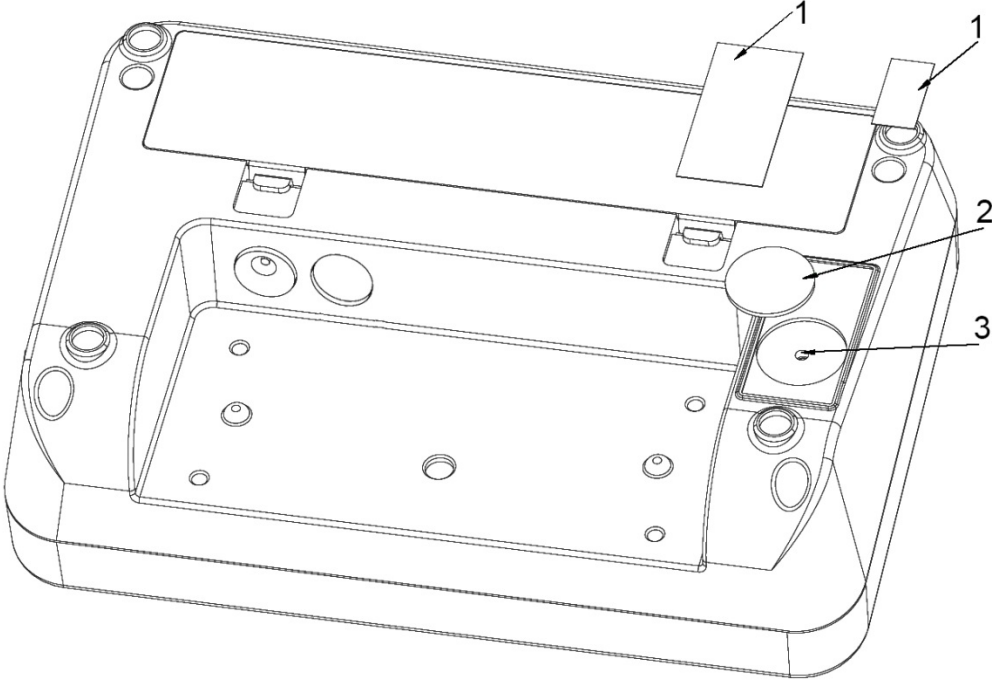













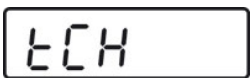

- 1. Self-destroying seal mark
- 2. Cover
- 3. Adjustment switch





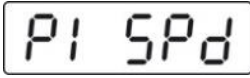







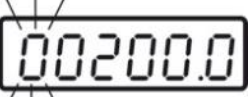

17 Adjustment

As the acceleration value due to gravity is not the same at every location on earth, each display unit with connected weighing plate must be coordinated - in compliance with the underlying physical weighing principle - to the existing acceleration due to gravity at its place of location (only if the weighing system has not already been adjusted to the location in the factory). This adjustment process must be carried out for the first commissioning, after each change of location as well as in case of fluctuating environment temperature. To receive accurate measuring values it is also recommended to adjust the display unit periodically in weighing operation.

	<ul style="list-style-type: none"> • Prepare the required adjustment weight. The adjustment weight to be applied depends on the capacity of a weighing scale, see chap. 1. Carry out adjustment as closely as possible to admissible maximum load of weighing scale. Info about test weights can be found on the Internet at: http://www.kern-sohn.com. • Observe stable environmental conditions. For warm-up time required for stabilisation see chap. 1.
---	--

Procedure:

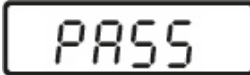
  	<p>⇒ In weighing mode, press  repeatedly until [tCH] appears.</p>
	<p>⇒ Press , [Pin] is displayed</p>
	<p>Press ,  and  one after the other, [P1 SPd] will appear</p>
  	<p>⇒ Press , „P2 CAL“ will be displayed</p> <p>⇒ Operate adjustment switch; for position see chap.16</p>

	<p>⇒ Press , [dESC] is displayed</p>
	<p>⇒ Press  repeatedly until [CAL] will be displayed.</p> <p>⇒ Confirm with , [UnloAd] appears</p>
	<p>⇒ Ensure that there are no objects on the weighing pan.</p> <p>⇒ Wait for stability display "STABLE", then confirm with </p>
 (example)	<p>⇒ The size of the currently set adjustment weight will be displayed.</p> <p>To change, select the digit to be altered by , and the numerical value by .</p> <p>⇒ Confirm with , [LoAd] appears.</p>
   	<p>⇒ Place adjustment weight in the centre of the weighing pan</p> <p>⇒ Wait until stability display „STABLE“ appears</p> <p>⇒ Confirm with , [PASS] is displayed.</p> <p>⇒ The balance carries out a selftest, after that [Err19] will be displayed and a signal will sound.</p> <p>⇒ Switch off the balance</p> <p>⇒ Take away adjustment weight</p> <p>⇒ Turn on balance again, after the selftest the balance changes into the weighing mode. Adjustment has now been completed successfully.</p>