



KERN & Sohn GmbH

Ziegelei 1
D-72336 Balingen
E-Mail: info@kern-sohn.com

Phone: +49-[0]7433- 9933-0
Fax: +49-[0]7433-9933-149
Internet: www.kern-sohn.com

Operating instructions Price calculating balance

KERN RIB

Version 1.1
2020-07
GB



RIB-HM



RIB-M

RIB-BA-e-2011



KERN RIB

Version 1.1 2020-07

Operating instructions Price calculating balance

Contents

1	Technical data	4
1.1	Dimensions	5
2	Appliance overview	6
2.1	Overview of display	8
2.2	Keyboard overview	10
3	Basic Information (General)	12
3.1	Intended use	12
3.2	Improper Use	12
3.3	Warranty	12
3.4	Monitoring of Test Resources	12
4	Basic Safety Precautions	13
4.1	Pay attention to the instructions in the Operation Manual.....	13
4.2	Personnel training.....	13
5	Transport and storage	13
5.1	Testing upon acceptance	13
5.2	Packaging / return transport	13
6	Unpacking, Setup and Commissioning	14
6.1	Installation Site, Location of Use	14
6.2	Unpacking.....	14
6.2.1	Placing.....	15
6.2.2	Scope of delivery / serial accessories:	15
6.3	Mains connection.....	15
6.4	Storage battery operation (optional).....	15
6.5	Assembly of tripod (only H models).....	16
6.6	Initial Commissioning.....	18
6.7	Adjustment.....	18
6.8	Verification.....	21
6.8.1	Adjustment switch and seals	22
6.9	Checking the balance verification settings	22
6.9.1	Service mode.....	23
7	Menu	24
7.1	Navigation in the menu.....	24
7.2	Menu overview	25
8	Operation	26
8.1	Turn on/off	26
8.2	Zeroing	26
8.3	Weighing with tare	26
8.4	Overload warning	27
9	Weighing with price determination	27
9.1	Basic price entry via keyboard	27
9.2	Memory for basic price (PLU = Price look up).....	28
10	Additional useful functions	29
10.1	Display background illumination.....	29
10.2	Signal tone.....	30

11 Servicing, maintenance, disposal 31
11.1 Cleaning 31
11.2 Servicing, maintenance 31
11.3 Disposal..... 31

12 Instant help..... 32
12.1 Error messages 32

1 Technical data

Models without vertical display:

KERN	RIB 6K-3M	RIB 10K-2M	RIB 30K-2M
Weighing range (max)	3 kg / 6 kg	6 kg / 15 kg	15 kg / 30 kg
Readability (d)	1 g / 2 g	2 g / 5 g	5 g / 10 g
Minimum load (Min)	20 g; 40 g	40 g; 100 g	100 g, 200 g
Verification value (e)	1 g / 2g	2 g / 5 g	5 g / 10 g
Verification class	III	III	III
Reproducibility	1 g / 2 g	2 g / 5 g	5 g / 10 g
Linearity	± 1 g / ±2 g	± 2 g / ± 5 g	± 5 g / ±10 g
Recommended adjusting weight (not supplied)	5 kg; 1 kg (F2)	10 kg; 5 kg (M1)	20 kg; 10 kg (M1)
Stabilization time	2 s		
Heating time (operating temperature)	10 min		
Net weight (kg)	3.2 kg		
Admissible ambient temperature	-10° C to 40° C		
Allowable air humidity	0 % - 80 % (non-condensing)		
Electric power supply	Mains adapter 220 V – 240 V AC 50 Hz balance 12 V, 500 mA		
Rechargeable battery (optional)	6 V, 4 Ah		
	Operating time – background lighting OFF 80 hrs.		
	Loading time approx. 14 hrs.		

Models with post-mounted display:

KERN	RIB 6K-3HM	RIB 10K-2HM	RIB 30K-2HM
Weighing range (max)	3 kg / 6 kg	6 kg / 15 kg	15 kg / 30 kg
Readability (d)	1 g / 2 g	2 g / 5 g	5 g / 10 g
Minimum load (Min)	20 g; 40 g	40 g; 100 g	100 g; 200 g
Verification value (e)	1 g / 2g	2 g / 5 g	5 g / 10 g
Verification class	III	III	III
Reproducibility	1 g / 2 g	2 g / 5 g	5 g / 10 g
Linearity	$\pm 1 \text{ g} / \pm 2 \text{ g}$	$\pm 2 \text{ g} / \pm 5 \text{ g}$	$\pm 5 \text{ g} / \pm 10 \text{ g}$
Recommended adjusting weight (not supplied)	5 kg; 1 kg (F2)	10 kg; 5 kg (M1)	20 kg; 10 kg (M1)
Stabilization time	2 s		
Heating time (operating temperature)	10 min		
Net weight (kg)	3.8 kg		
Admissible ambient temperature	-10° C to 40° C		
Allowable air humidity	0 % - 80 % (non-condensing)		
Electric power supply	Mains adapter 220 V – 240 V AC 50 Hz balance 12 V, 500 mA		
Rechargeable battery (optional)	6 V, 4 Ah		
	Operating time – background lighting OFF 80 hrs.		
	Loading time approx. 14 hrs.		

1.1 Dimensions

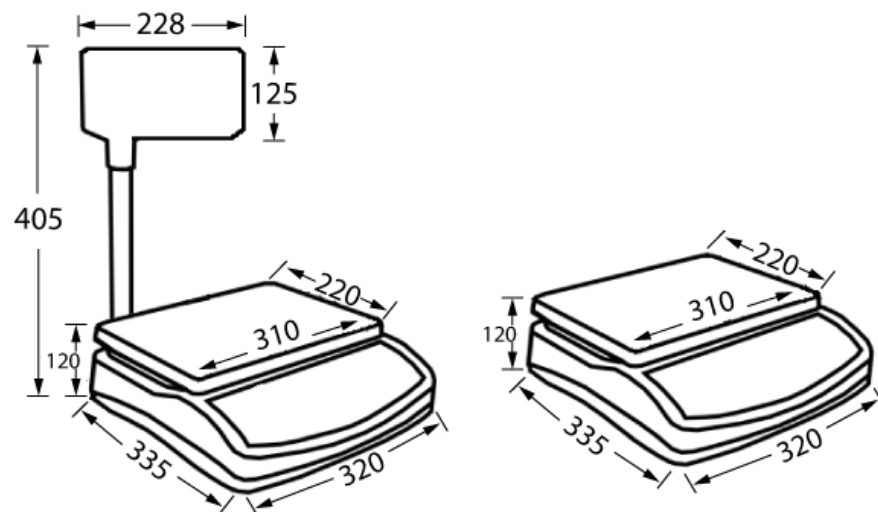

2 Appliance overview

Models without post-mounted display:

Operating side



Rear



Models with post-mounted display:

Operating side



Rear



1. Weighing plate / rechargeable battery compartment (under weighing plate)
2. Bubble level
3. Post-mounted display

Bottom of the balance

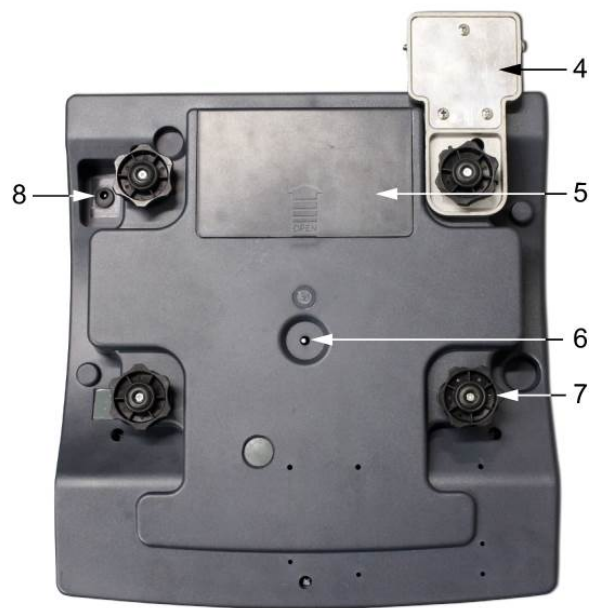

4. Tripod holder (only H models)
5. Battery compartment
6. Adjustment switch
7. Footscrews
8. Mains adapter connection

2.1 Overview of display

- Balance display (for all models)
- Balance display and post-mounted display (only for models with tripod)

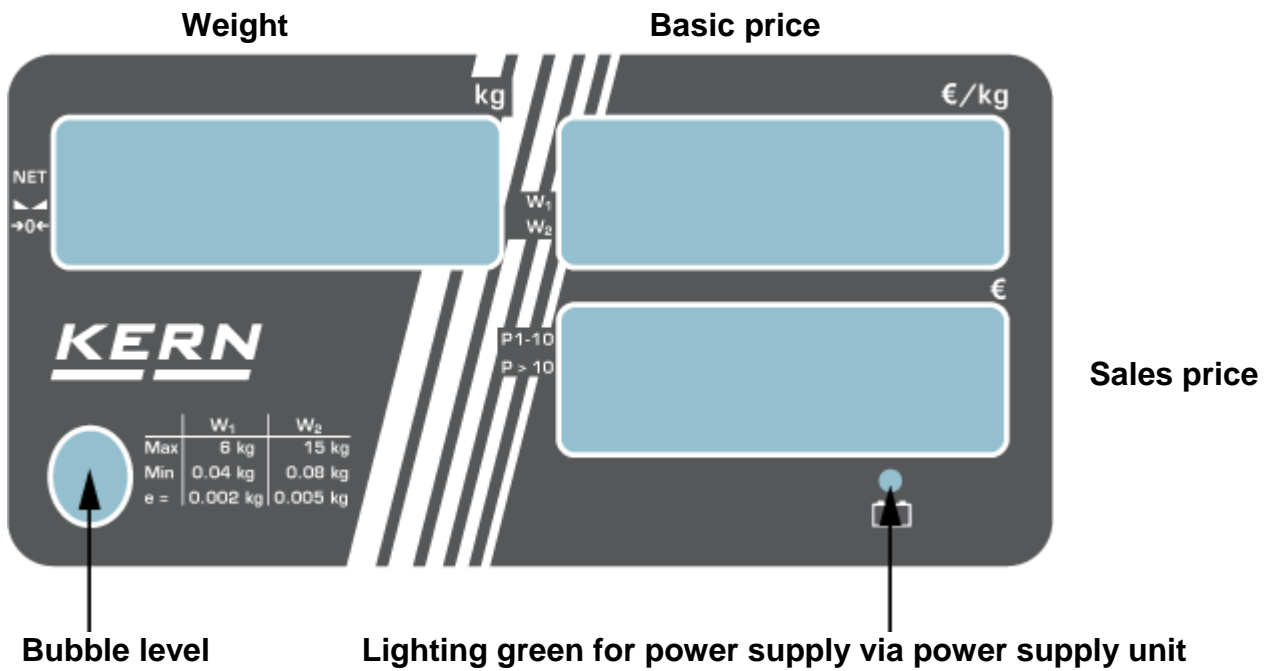

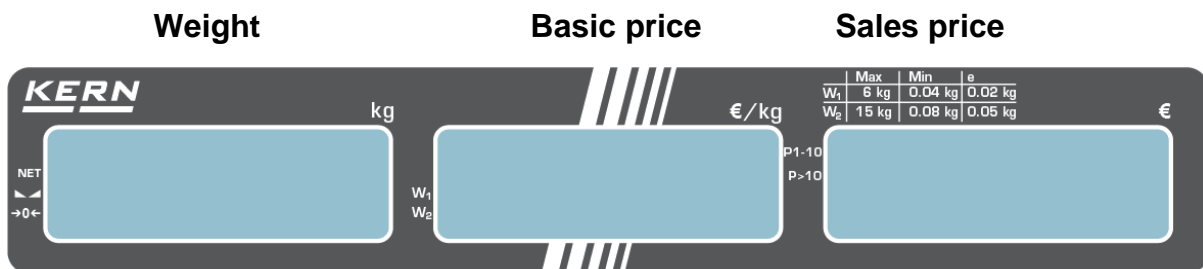

- Display on backside of balance (only for models without tripod)





Display weight

Here, the weight of your goods is displayed.

	◀	Battery very low
g/kg	◀	Weighing unit
NET	◀	Net weight
	◀	Stability display
→0←	◀	Zeroing display

Display basic price

	◀	Battery very low
	◀	Range
€/kg		Basic price in €/kg

Display sale price

Here the sales price is displayed in Euro [€].







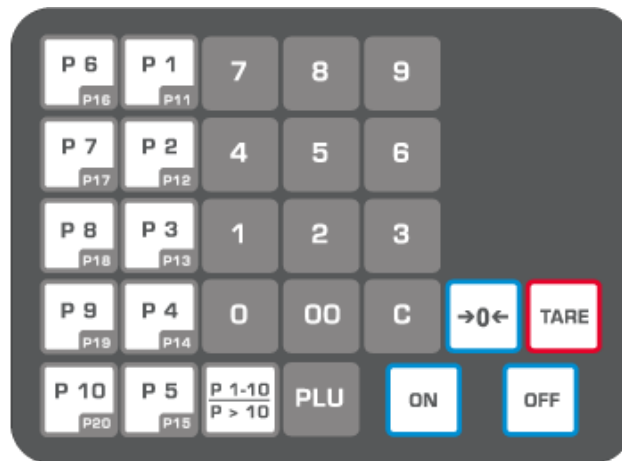

	◀	PLU's <ul style="list-style-type: none">• Memory location 1-10• Memory location 11-20
---	---	---





Display mains operation

	LED	
	green	for connection to power supply

2.2 Keyboard overview



Selection	Function
 ~ 	<ul style="list-style-type: none"> • PLU keys
 ~ 	<ul style="list-style-type: none"> • Numeric keys
	<ul style="list-style-type: none"> • Delete basic price <ul style="list-style-type: none"> - In menu: Exit function / back to weighing mode.
	<ul style="list-style-type: none"> • Store basic price • In menu: Confirm entry
	<ul style="list-style-type: none"> • Change between the memory locations 1-10 and 11-20
	<ul style="list-style-type: none"> • Calculate sales price

	<ul style="list-style-type: none"> • Zeroing <ul style="list-style-type: none"> - Change back in menu - For numeric entry: Move decimal point to the left 	
	<ul style="list-style-type: none"> • Taring 	<p>In menu:</p> <ul style="list-style-type: none"> • Call menu together with  • Change forward in menu <p>For numeric entry:</p> <ul style="list-style-type: none"> • Move decimal point to the right
	<ul style="list-style-type: none"> • Switch on balance 	
	<ul style="list-style-type: none"> • Switch off the balance 	

3 Basic Information (General)

3.1 Intended use

The balance you purchased is intended to determine the weighing value of material to be weighed. It is intended to be used as a “non-automatic balance”, i.e. the material to be weighed is manually and carefully placed in the centre of the weighing pan. As soon as a stable weighing value is reached the weighing value can be read.

3.2 Improper Use

Do not use balance for dynamic weighing. In the event that small quantities are removed or added to the material to be weighed, incorrect weighing results can be displayed due to the “stability compensation”. (Example: Slowly draining fluids from a container on the balance.) Do not leave permanent load on the weighing pan. This may damage the measuring system.

Impacts and overloading exceeding the stated maximum load (max) of the balance, minus a possibly existing tare load, must be strictly avoided. Balance may be damaged by this.

Never operate balance in explosive environment. The serial version is not explosion protected.

The structure of the balance may not be modified. This may lead to incorrect weighing results, safety-related faults and destruction of the balance.

The balance may only be used according to the described conditions. Other areas of use must be released by KERN in writing.

3.3 Warranty

Warranty claims shall be voided in case

- Our conditions in the operation manual are ignored
- The appliance is used outside the described uses
- The appliance is modified or opened
- Mechanical damage or damage by media, liquids, natural wear and tear
- The appliance is improperly set up or incorrectly electrically connected
- The measuring system is overloaded

3.4 Monitoring of Test Resources

In the framework of quality assurance the measuring-related properties of the balance and, if applicable, the testing weight, must be checked regularly. The responsible user must define a suitable interval as well as type and scope of this test. Information is available on KERN's home page (www.kern-sohn.com) with regard to the monitoring of balance test substances and the test weights required for this. In KERN's accredited DKD calibration laboratory test weights and balances may be calibrated (return to the national standard) fast and at moderate cost.

4 Basic Safety Precautions

4.1 Pay attention to the instructions in the Operation Manual



Carefully read this operation manual before setup and commissioning, even if you are already familiar with KERN balances.

4.2 Personnel training

The appliance may only be operated and maintained by trained personnel.

5 Transport and storage

5.1 Testing upon acceptance

When receiving the appliance, please check packaging immediately, and the appliance itself when unpacking for possible visible damage.

5.2 Packaging / return transport



- ⇒ Keep all parts of the original packaging for a possibly required return.
- ⇒ Only use original packaging for returning.
- ⇒ Prior to dispatch disconnect all cables and remove loose/mobile parts.
- ⇒ Reattach possibly supplied transport securing devices.
- ⇒ Secure all parts such as the glass wind screen, the weighing platform, power unit etc. against shifting and damage.

6 Unpacking, Setup and Commissioning

6.1 Installation Site, Location of Use

The balances are designed in a way that reliable weighing results are achieved in common conditions of use.

You will work accurately and fast, if you select the right location for your balance.

On the installation site observe the following:

- Place the balance on a firm, level surface;
- Avoid extreme heat as well as temperature fluctuation caused by installing next to a radiator or in the direct sunlight;
- Protect the balance against direct draughts due to open windows and doors;
- Avoid jarring during weighing;
- Protect the balance against high humidity, vapours and dust;
- Do not expose the device to extreme dampness for longer periods of time. Non-permitted condensation (condensation of air humidity on the appliance) may occur if a cold appliance is taken to a considerably warmer environment. In this case, acclimatize the disconnected appliance for ca. 2 hours at room temperature.
- Avoid static charge of goods to be weighed or weighing container.

If electro-magnetic fields or static charge occur, or if the power supply is unstable major deviations on the display (incorrect weighing results) are possible. In that case, the location must be changed.

6.2 Unpacking

Carefully remove the balance from the packaging, remove plastic cover and setup balance at the intended workstation.

6.2.1 Placing

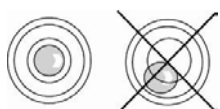

Level balance with foot screws until the air bubble of the water balance is in the prescribed circle.

6.2.2 Scope of delivery / serial accessories:

- Balance, see chap. 2
- Mains adapter
- Protective cover
- Operating instructions
- Tripod (only for H models)

6.3 Mains connection

Power is supplied via the external mains adapter. The stated voltage value must be the same as the local voltage.



Only use KERN original mains adapter. Using other makes requires consent by KERN.

6.4 Storage battery operation (optional)



The optionally supplied battery is charged with the supplied power supply.

Before the first use, the battery should be charged by connecting it to the mains power supply for at least 14 hours.

- The appearance of the battery symbol  in the display windows indicates that the battery is almost exhausted. Charge the battery with the help of the supplied power pack.

 is displayed	Rechargeable battery capacity below 5.6 V
 Flashing	Rechargeable battery capacity below 5.5 V
Balance will switch off automatically if the rechargeable battery capacity is below 5.4 V	

6.5 Assembly of tripod (only H models)

	
Connection cable - on the balance	- and on the tripod

Fix the tripod on the balance as described below:

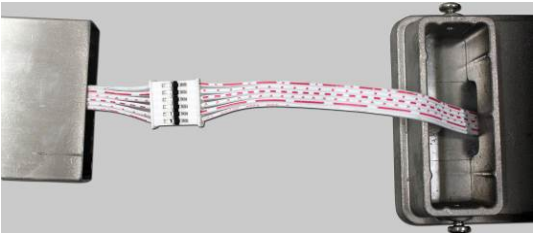
	Loosen the side screws from the tripod holder of the balance
	Plug together the both connections. Ensure that the cables are not twisted.

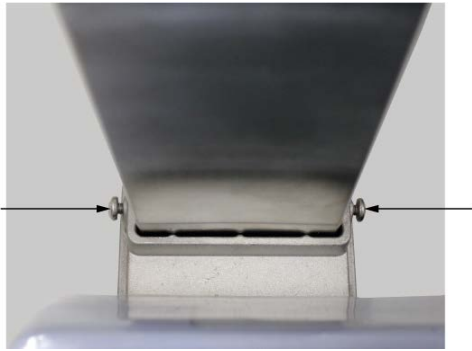

Plug the tripod carefully into the tripod holder of the balance.

Ensure that the cables are not squeezed.

Align the display on the tripod towards the customer (see. fig. below).



Fix the tripod using the two side screws of the tripod holder.

Switch on the balance and check if the tripod display works.

Should this not be the case, detach the tripod from the balance and check the connections.

6.6 Initial Commissioning

In order to obtain exact results with the electronic balances, your balance must have reached the operating temperature (see warming up time chap. During this warming up time the balance must be connected to the power supply (mains, accumulator).

The accuracy of the balance depends on the local acceleration of gravity. Strictly observe hints in chapter Adjustment.

6.7 Adjustment

As the acceleration value due to gravity is not the same at every location on earth, each balance must be coordinated - in compliance with the underlying physical weighing principle - to the existing acceleration due to gravity at its place of location (only if the balance has not already been adjusted to the location in the factory). This adjustment process must be carried out for the first commissioning, after each change of location as well as in case of fluctuating environment temperature. To receive accurate measuring values it is also recommended to adjust the balance periodically in weighing operation.

- i** The adjustment is locked for verified balances. Carrying out adjustment requires that the seal is destroyed and the adjusting switch is confirmed in step 3 when turning on the scale. For position of adjusting switch, see chap. 6.8.1

Attention:

After destruction of the seal the balance must be re-verified by an authorised agency and a new verification wire/seal mark fitted before it can be reused for applications subject to verification.

Procedure when adjusting:

Observe stable environmental conditions. A warming up time (see chapter 1) is required for stabilization. Ensure that there are no objects on the weighing pan. Arrange adjustment weight, details see chap.1 „Technical data“

	<p>In weighing mode press  and keep pressed; additionally press .</p>
--	---

	<p>If „CAL OFF“ appears in the window of the basic price or if the balance does not react, the verification switch on the lower side of the balance must be set to position „ON“, see chap. 6.8.1</p>
--	---

	<p>The value of the adjustment weight appears. The first digit is flashing. Either</p> <ul style="list-style-type: none"> - Take over the displayed adjustment weight, <p>or</p> <ul style="list-style-type: none"> - use the numeric keys to enter a new adjustment weight <p>Put adjustment weight in the centre of the weighing plate and confirm by .</p>
--	--

	<p>„-----“ will be displayed shortly, the balance will be adjusted and after that changes automatically into weighing mode.</p>
	<p>The weight value of the adjustment weight on the weighing plate will be displayed. Now the process of adjustment has been finished successfully.</p>



In case of an adjustment error or incorrect adjusting weight the display will show an error message; repeat adjustment process.

6.8 Verification

General hints:

According to EU directive 2014/31/EU balances must be officially verified if they are used as follows (legally controlled area):

- a) For commercial transactions if the price of goods is determined by weighing.
- b) For the production of medicines in pharmacies as well as for analyses in the medical and pharmaceutical laboratory.
- c) For official purpose.
- d) For manufacturing final packages.

In cases of doubt, please contact your local trade in standard.

After verification the balance is sealed at the indicated positions.

Verification of the balance is invalid without the "seal".

Verification notes

An EU type approval exists for balances described in their technical data as verifiable. If a balance is used where obligation to verify exists as described above, it must be verified and re-verified at regular intervals.

Re-verification of a balance is carried out according to the respective national regulations. The validity for verification of balances in Germany is e.g. 2 years. The legal regulation of the country where the balance is used must be observed!

Balances with obligation to verify must be taken out of operation if:

- **The weighing result of the balance is outside the error limit.** Therefore, in regular intervals load balance with known test weight (ca. 1/3 of the max. load) and compare with displayed value.
- **The reverification deadline has been exceeded.**

6.8.1 Adjustment switch and seals

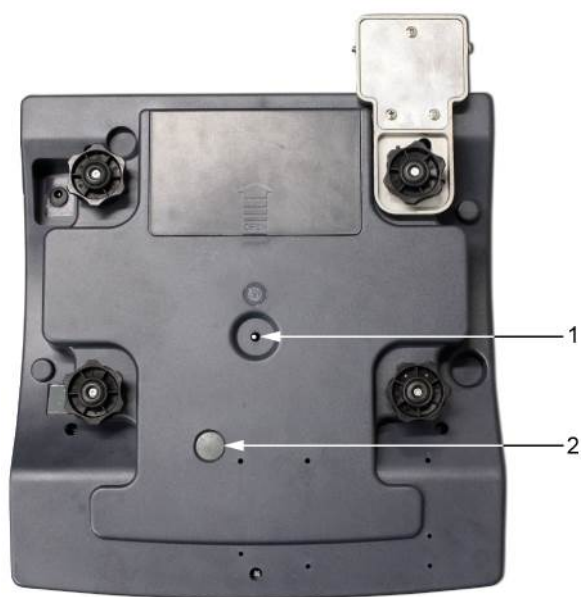

1. Adjustment switch
2. Verification switch



Sealing points on both sides

6.9 Checking the balance verification settings

For the adjustment, the balance must be switched over to service mode.



In the service mode the parameters of the balance can be modified.
If this happened accidentally, please contact KERN.

In calibrated scales the service mode is locked individually for each switch.
To disable the access lock, destroy the seal and actuate the switch.

Attention:

After destruction of the seal the balance must be re-verified by an authorised agency and a new verification wire/seal mark fitted before it can be reused for applications subject to verification.







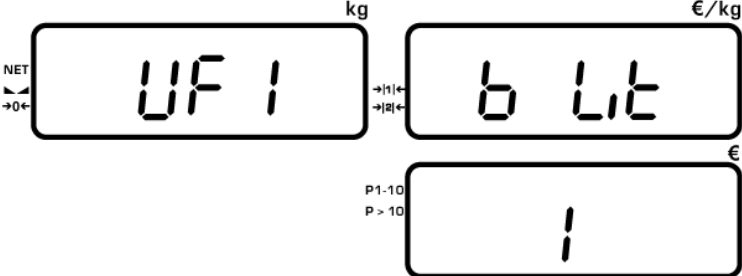

6.9.1 Service mode

This overview of the service parameters is merely for checking the parameters set by the appropriate Bureau of Standards. No changes may be made.





Buttons	Display		Description
in weighing mode			
Press TARE and keep pressed and press 3 additionally	G	00	Gravity
		x.xxxxx	
Press TARE and keep pressed and press 5 additionally			
	1	Keyboard test	
	2	Adjustment weight internal value	
	3	Software version (example)	
Press TARE and keep pressed and press 6 additionally	bAt 6.7	Ad	Battery voltage internal value AD converter value
		xxxxxx	

7 Menu

7.1 Navigation in the menu

<p>Call up menu</p> 	<p>In weighing mode press  and keep pressed; additionally press .</p> <p>The first menu item UF1 (background illumination) will be displayed</p>
<p>Select menu block</p> <ul style="list-style-type: none">• Use  to change menu item backward• Use  to change menu item forward	
<p>Set parameter</p> <ul style="list-style-type: none">• Using numeric key  to 	
<p>Confirm setting</p> <p>⇒ Press </p>	
<p>Back to weighing mode / exit function without saving</p> <p>⇒ Press </p>	

7.2 Menu overview



Function		Settings		Description
		 to  and 		
UF1	b Lit			Background illumination, see chap. 10.1
	1 (example)	1		Background illumination automatically off
		0		Background lighting off
UF2	rS232			not documented
	1 (example)	0-3		
UF3	bAUd			not documented
	9600 (example)	1200, 2400, 4800, 9600		
UF4	bBEEP			Signal tone when pressing button
	oFF (example)	0	off	Signal tone off
		1	on	Signal tone on

8 Operation

8.1 Turn on/off

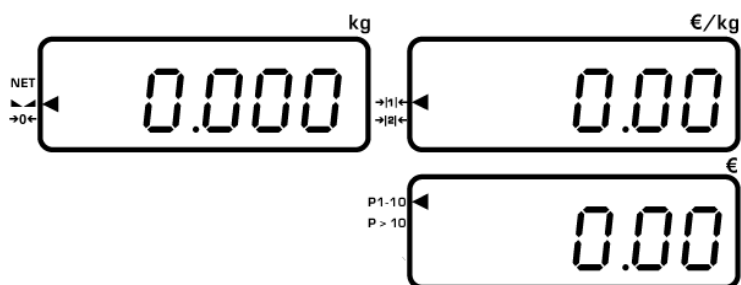
To switch on, press . The balance will carry out a self-test. As soon as the weight display shows "0" in all the three display windows your balance is ready to weigh.



To switch off, press  and keep pressed. In the weight display appears „oFF“, continue to press  until the display „oFF“ extinguishes. The balance is now switched off.

8.2 Zeroing

Resetting to zero corrects the influence of light soiling on the weighing plate.

⇒ Unload the balance

Press , the balance starts resetting to zero. The indicator [◀] next to →0← appears.

8.3 Weighing with tare

⇒ Deposit weighing vessel. After successful standstill control press the  button. Zero display and the indicator [◀] next to [NET] appear.

⇒ Weigh the material, the net weight will be indicated.

⇒ The weight of the weighing container will be displayed as a minus number after removing the weighing container.

⇒ To delete the TARE value unload the weighing plate and press , the indicator [◀] next to [NET] extinguishes.

8.4 Overload warning

Overloading exceeding the stated maximum load (max) of the balance, minus a possibly existing tare load, must be strictly avoided. This could cause damage to the balance.



Exceeding maximum load is indicated by the display of „hhhhh“ and a signal tone (if it before in the menu has been set to „on“). Unload balance or reduce preload.

9 Weighing with price determination

As soon as the goods to be weighed are placed on the balance and the basic price has been set the price is calculated automatically and displayed in the provided field.

9.1 Basic price entry via keyboard

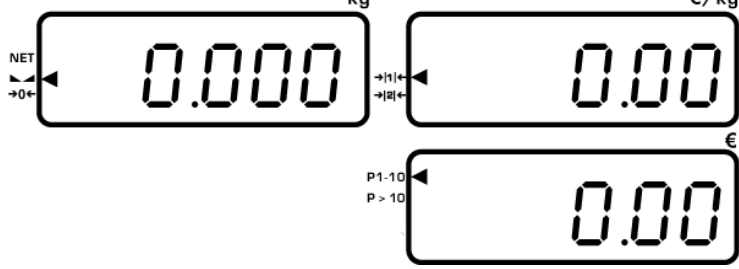
⇒ When using the weighing container, tare by using , see chap. 8.3.

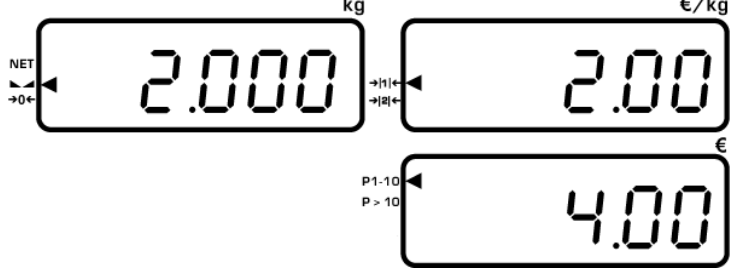
 <p>(example)</p>	Place weighing good A and enter basic price via the numeric keys  -  .
 <p>(example)</p>	The sales price will be automatically calculated.



- The set basic price is deleted by .
- Calculating the change, see chap. 9.2

9.2 Memory for basic price (PLU = Price look up)

The balance is able to store up to 40 basic prices.

Save:

⇒ Unload weighing plate

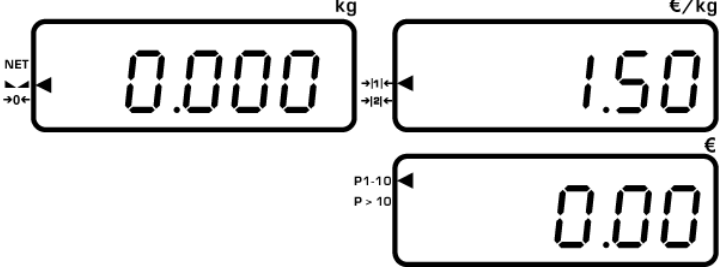
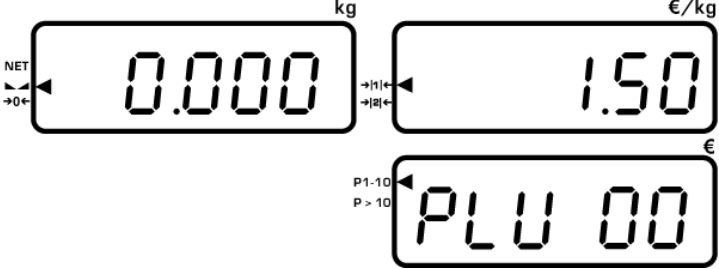
 <p>(example)</p>	<p>Enter basic price via the numeric keys 0 ~ 9.</p>
	<p>Press PLU, „PLU 00“ will be displayed shortly. During this display enter the desired memory location using buttons P 1 ~ P 10. The basic price is saved at the entered PLU.</p>

Retrieve / show sales price:

⇒ Place goods to be weighed

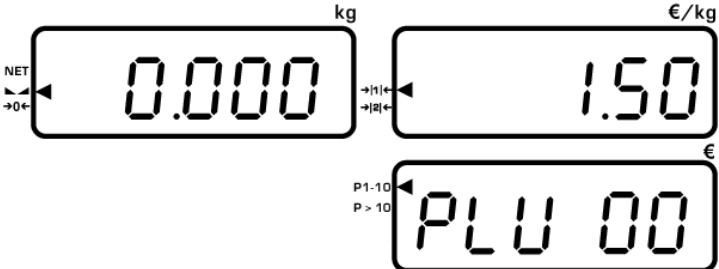
 <p>(example)</p>	<p>Press the desired PLU P 1 ~ P 10. The basic price saved under this PLU will be displayed and the sales price automatically calculated.</p>
--	---

10 Additional useful functions

10.1 Display background illumination

<p>(example)</p>	<p>In weighing mode press TARE and keep pressed; additionally press 4. The menu item UF1 (background illumination) will be displayed</p>
<p>(example)</p>	<p>Use the numeric keys 0 and 1 for the required setting.</p>

0	Background lighting off	To save battery power
1	Background illumination automatically off	Backlighting automatically switched off 10 seconds after achieving stable weighing value to save battery power

<p>(example)</p>	<p>Select desired setting by PLU.</p>
	<p>Then the balance changes automatically into weighing mode. The selected setting has been accepted.</p>

10.2 Signal tone

There exists the possibility to activate a signal which sounds by pressing a key or with overload.

For this purpose proceed as follows:

<p>(example)</p>	<p>In weighing mode press TARE and keep pressed; additionally press 4. The menu item UF1 (background illumination) will be displayed</p>
<p>(example)</p>	<p>Press TARE repeatedly until the menu item UF4 appears. Use the numeric keys 0 and 1 for the required setting.</p>

0	Signal tone off
1	Signal tone on

<p>(example)</p>	<p>Select desired setting by PLU.</p>
	<p>Then the balance changes automatically into weighing mode. The selected setting has been accepted.</p>

11 Servicing, maintenance, disposal

11.1 Cleaning

Before cleaning, please disconnect the appliance from the operating voltage.

Please do not use aggressive cleaning agents (solvents or similar agents), but a cloth dampened with mild soap suds. Ensure that no liquid penetrates into the device and wipe with a dry soft cloth.

Loose residue sample/powder can be removed carefully with a brush or manual vacuum cleaner.

Spilled weighing goods must be removed immediately.

11.2 Servicing, maintenance

The appliance may only be opened by trained service technicians who are authorized by KERN.

Before opening, disconnect from power supply.

11.3 Disposal

Disposal of packaging and appliance must be carried out by operator according to valid national or regional law of the location where the appliance is used.

12 Instant help

In case of an error in the program process, briefly turn off the balance and disconnect from power supply. The weighing process must then be restarted from the beginning.

Fault	Possible cause
The displayed weight does not glow.	<ul style="list-style-type: none">• The balance is not switched on.• The mains supply connection has been interrupted (mains cable not plugged in/faulty).• Power supply interrupted.• Batteries are inserted incorrectly or empty• No batteries inserted.
The displayed weight is permanently changing	<ul style="list-style-type: none">• Draught/air movement• Glass doors not closed• Table/floor vibrations• Weighing pan has contact with other objects.• Electromagnetic fields / static charging (choose different location/switch off interfering device if possible)
The weighing result is obviously incorrect	<ul style="list-style-type: none">• The display of the balance is not at zero• Adjustment is no longer correct.• The balance is on an uneven surface.• Great fluctuations in temperature.• Electromagnetic fields / static charging (choose different location/switch off interfering device if possible)

Should other error messages occur, switch balance off and then on again. If the error message remains inform manufacturer.

12.1 Error messages

ERR 4	Zero range exceeded
ERR 5	Invalid entry
ERR 6	Damaged electronics