



Sauter GmbH

Ziegelei 1
D-72336 Balingen
e-mail: info@kern-sohn.com

Phone : +49-[0]7433- 9933-0
Fax: +49-[0]7433-9933-149
Internet: www.sauter.eu

Instruction Manual Sound Level Meter

SAUTER SW 1000 / SW 2000

Version 2.0
04/2020
GB



PROFESSIONAL MEASURING

SW-BA-e-2020



SAUTER SW 1000 / SW 2000

V. 2.0 05/2021

Instruction Manual Sound Level Meter

Congratulations on purchasing a high-quality sound level meter from SAUTER. We wish you much pleasure with your quality measuring instrument and its complex range of functions. For questions, wishes or suggestions we are at your disposal.

Table of contents:

1.	Introduction	4
1.1	General description	4
1.2	Applications	4
1.3	Functions	4
1.4	Functional upgrades	5
1.5	Specification	5
1.6	Information for regular tests	7
1.7	Main components	7
1.8	Parts list	8
1.9	Illustration Scope of delivery	8
2.	View and operation	8
2.1	Keypad	9
2.2	Microphone connection	10
2.3	Draft shield	11
2.4	Data and power supply connection	11
2.5	Battery	13
2.6	GPS	14
3.	measurement screen	15
3.1	Symbols and meaning of the screen display	15
3.2	Screen in Level Measurement Mode	16
3.3	Screen of the 1/1-octave mode	18
4.	operation and setting of the menu	19
4.1	Function	19
4.2	Calibration	19
4.3	Measurement	22
4.4	Setup	28
4.5	Language	35
4.6	Output (output)	35
4.7	Factory settings	37
5.	data transmission protocol RS-232	37
5.1	Hardware configuration and interface settings	37
5.2	Transmission protocol	38
5.3	Instructions	42
6.	operating instructions	43
6.1	Operation	43
6.2	Common problems and solutions	44

6.3 Calibration	44
6.4 Firmware Update	44
6.5 Warranty	46
7. Annex	47
7.1 Corrections for typical reflections from the housing of the sound level meter and sound scattering around the microphone	47
7.2 Correcting the Draft Shield in the Free Field	48
7.3 Corrections of the electret microphone	49
7.4 Typical frequency response and corresponding upper limit	50
7.5 Technical data of the 1/1 octave filter	51
7.6 Glossary	51

1. Introduction

1.1 General description

The new measuring instruments **SW 1000/ SW 2000** are upgrades of a new generation of octave sound meters according to the market requirements for the basic instrument SW 1000/200, which meets the requirements of the IEC standard as well as the Chinese GB/T standard for 1/1 octave measuring instruments.

The SW 1000/ SW 2000 is a digital sound pressure measuring instrument developed and produced by the Kern company. The high-precision 24-bit A/D converter makes the instrument the ideal choice for various measurement tasks, for example, for measuring environmental noise, vehicle noise and for industrial applications.

The new types contain two cores (DSP+ARM) in a single chip ARM with floating point display and instead of the fixed point calculation a floating point calculation, which significantly improves accuracy and stability. The redesign of the analog front-end circuit also reduces the background noise and increases the linear measuring range of the product. The newly developed algorithm has only one measurement range with a dynamic range of more than 120 dB, but still meets the standard.

SW 1000 is a **class 1** measuring instrument and the **SW 2000** is a **class 2 measuring instrument**.

1.2 Applications

- Simple noise measurement
- Determination of environmental noise
- Product Quality Control
- Evaluation of technical measures for noise reduction

1.3 Functions

- Class 1 (**SW 1000**) and Class 2 (**SW 2000**)
Sound pressure measuring device
- Complies with IEC 61672-1:2013, ANSI S1.4-1983 and ANSI S1.43-1997
- 1/1 octave according to the standards IEC 61260-1:2014 and ANSI S1.11-2004.
- Linearity range: 20 dBA to 134 dBA (**SW 1000**), 25 dBA to 136 dBA (**SW 2000**)
- Dynamic measuring range over 123 dB for model **SW 1000** and 122 dB for model **SW 2000**.
- Frequency weighting: A/B/C/Z. Time weighting: fast/slow/pulses
- 3 profiles and 14 user-defined measurements are calculated in parallel with different frequency/time weightings.
- Calculation of SPL, LEQ, Max, Min, Peak, SD, SEL, E
- LN statistics and display of the time curve
- User defined integral period measurement, integral period up to 24 hours.
- Wide frequency response, high dynamic range and low background noise due to high-speed ARM core with floating point unit
- 4G-Micro SD card (TF card) as mass storage

- Remote control connection RS-232
- Internal GPS module (option), support of GPS time

1.4 Functional upgrades

➤ Single chip high speed ARM with floating point unit	➤ USB port implemented
➤ LCD with white backlight	➤ Firmware update via USB (power supply also via USB)
➤ Integral period from 1 s to 24 h	➤ Support of automatic measurements by timer function.
➤ New protocol steps 0.1 s, 0.2 s and 0.5 s.	➤ Internal GPS (option) with GPS time
➤ 5 Templates for saving the user settings	➤ Only one measuring range to cover the dynamic range of 123 dB
➤ B weighting for ANSI standard added	➤ Reduced background noise (only for class 1 instruments)
➤ Automatic switch-on with external power supply, easy integration	➤ Upper measurement limit: 134 dBeff/137 dBeff (50 mV/Pa)

1.5 Specification

Type	SW 1000	SW 2000
Accuracy	Class 1 (Group X)	Class 2 (Group X)
Standard	GB/T 3785.1-2010, IEC 60651:1979, IEC 60804:2000 IEC 61672-1:2013, ANSI S1.4-1983, ANSI S1.43-1997	
octave1	1/1 octave mid-frequencies: 31.5 Hz to 16 kHz GB/T 3241-2010, IEC 61260-1:2014 ANSI S1.11-2004	1/1 octave center frequencies: 31.5 Hz to 8 kHz GB/T 3241-2010, IEC 61260-1:2014 ANSI S1.11-2004
Supplied Microphone	MPA231T: Pre-polarized measuring microphone 1/2", class 1 Sensitivity: 50 mV/Pa. Frequency range: 10 Hz to 20 kHz.	MPA200T: Pre-polarized measuring microphone 1/2", class 2 Sensitivity: 40 mV/Pa. Frequency range: 20 Hz to 12.5 kHz.
Microphone interface	TNC connectors with ICCP supply (4 mA)	
Detector / Filter	Purely digital signal processing with floating point unit (digital detector and Filter)	
Integral period	User-definable integral period 1 s - 24 h [User]. Repeat time: infinite or 1 to 9999	
Protocol step	0.1, 0.2 s, 0.5 s, 1 s to 24 h	
Measurement functions	LXY _(SPL) , LXeq, LXYS, LXSEL, LXE, LXYmax, LXYmin, LXPeak, LXN. Where X is the frequency weighting: A, B, C, Z; Y is the time weighting: F, S, I; N is the statistical portion: 1 to 99. 3 profiles and 14 user-defined measurements are	

	calculated in parallel with different frequency/time weightings.	
24 h Measurement	Automatic measurement according to user-defined date and time settings and storage of history data	
Frequency weighting	Parallel A, B, C, Z	
Time Weighting	Parallel detection of F, S, I and Peak	
Internal noise 2	Sound 18 dB (A), 23 dB (C), 31 dB (Z) Electrical data: 11 dB(A), 16 dB(C), 21 dB(Z)	Sound 20 dB(A), 26 dB(C), 31 dB(Z) Electrical data: 14 dB(A), 19 dB(C), 24 dB(Z)
Upper limit value 2	134 dB(A) Increased to 154 dB(A) for a microphone with 50 mV/Pa	136 dB(A) Increased to 154 dB(A) for a microphone with 50 mV/Pa
Frequency Response¹	10 Hz to 20 kHz	20 Hz ~ 12.5 kHz
Linearity range 2, 3	20 dB(A) to 134 dB(A)	25 dB(A) to 136 dB(A)
Dynamic range ²	123 dB (11 dB(A) to 134 dB(A))	122 dB (14dB(A) to 136 dB(A))
Peak C range^{2, 3}	45 dB(A) to 137 dB(A)	47 dB(A) to 139 dB(A)
Electrical input	Maximum input voltage 5 V _{rms} (7.07 V peak). Input impedance of the preamplifier > 6 GΩ	
Range setting	Single range to cover the entire dynamic range	
Resolution	24 bits	
Sampling rate	48 kHz	
Time course	Time domain noise curve display Duration: 1 minute, 2 minutes, 10 minutes	
LCD display	LCD 160 x 160 with white backlight, 14 contrast levels, display update in one second.	
Mass storage	4G Micro SD card (TF card)	
Post-processing	Post-processing software VA-SLM for reading, analyzing and generating reports from the stored data	
Data export	Direct connection to the computer to read the memory card (as USB drive)	
Output	AC voltage output (maximum 5 V _{EFF} , ±15 mA), DC voltage output (10 mV/dB, maximum 15 mA), Serial interface RS-232 and USB (USB drive mode or modem mode).	
Alarm	User-defined alarm threshold LED to indicate the alarm status	
Setup template	5 templates to store user setups for different applications, template can be stored on the Micro SD card	
Automatic switch-on	Automatic switch-on and automatic start of the measurement when operating voltage is applied, easy integration	
Power supply	4 alkaline batteries 1.5 V (LR6/AA/AM3), sufficient for about 10 hours (depending on battery). The operating voltage can	

	also be provided by an external DC power source (7 V - 14 V, 500 mA) and the USB port (5 V, 1 A).
RTC	The integrated buffer battery has been calibrated at the factory for an error of < 26 s in 30 days (< 10 ppm, (25 ± 16) °C). The backup battery ensures that the system clock continues to run even if the main batteries are changed. GPS time function available (option with GPS module)
Language	English, Chinese, Portuguese, Spanish, German, French
Firmware update	Firmware update via USB connection
Conditions	Temperature: -10 °C to 50 °C. Humidity: 20 % - 90 % relative humidity
Real-time temperature	Real-time temperature display on the main screen
Size (mm)	W 70 x H 300 x D 36
Weight	Approx. 620 g with 4 alkaline batteries
Option	
GPS	Receiver type: 50 channels Time to first measurement: Cold start 27 s, warm start: 27 s, hot start 1 s; Sensitivity: Tracking -161 dBm, new acquisition -160 dBm, cold start -147 dBm, hot start -156 dBm; Horizontal position accuracy: 2.5 m, time accuracy: 30 ns, speed accuracy: 0.1 m/s; update rate: 1 Hz, operating limits Dynamic ≤ 4 g, height < 50,000 m, speed < 500 m/s
Calibrator	CA111, Class 1, 94 dB/114 dB, 1 kHz
Note 1: For BSWA 200 instrument, ignore the result above 12.5 kHz due to the microphone frequency response for Class 2 instruments.	
Note 2: Data was measured with a microphone with a sensitivity of 50 mV/Pa for SW 1000 and 40 mV/Pa for BSWA 200.	
Note 3: Measurement according to the requirements of GB/T3785 and IEC61672.	

1.6 Information for regular tests

- Reference sound pressure: 94,0 dB.
- Reference direction of incidence : parallel to the direction of incidence of the microphone.
- Reference point of the microphone Center of the microphone diaphragm.
- Reference direction of incidence: direction perpendicular to the microphone diaphragm

1.7 Main components

Component name	Type	Description
Microphone	SW-A01	Class 1 microphone
	SW-A02	Class 2 microphone

1.8 Parts list

No.	Type	Description
Standard		
1	SW 1000/2000	Sound pressure measuring device without microphone
2		ICCP preamplifier with TNC connection
3	SW-A01/SW-A02	Class 1 (1000) or Class 2 (200) microphone
4	Draft shield SW-A03	Windscreen 90 mm diameter for microphone 1/2
5	Micro SD card SW-A04	4G memory card for data storage
6	Battery	4 alkaline batteries (LR6 / AA / AM3
7	Power supply unit	Power supply unit 9 V/500 mA
8	Mini USB cable	For connection to the computer
Option		
1		GPS module and antenna
2	Tribrach SW-A05	Stand for sound pressure measuring device
3	Printed operating manual	Printed operating manual

1.9 Illustration Scope of delivery

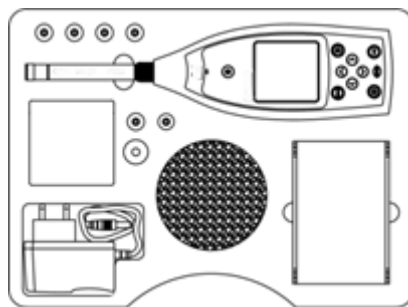

☆ **Note** The details of the parts list may vary depending on the order.

2. View and operation

The measuring instruments SW 1000 and SW 2000 are identical in appearance and keypad. LCD display, keypad and LED indicators are located on the front of the instrument.

2.1 Keypad

The sound level meter has 10 keys:



<power button>:

Press this button for 2 seconds to switch on the sound pressure meter. If the sound pressure gauge is in stop status, press this button for 2 seconds to enter the power off dialog and then press < **Enter** > to turn off the sound pressure gauge.

☆ **Note:** The < **Enter** > key will not work as long as the sound pressure meter is taking measurements.

<ESC>:

To exit the menu and return to a previous menu You can also delete the progress curve on the time history screen by pressing the <ESC> key.

<Enter>:

To call up the menu of the next level or to confirm parameter changes or to save the current data in CSD format when the measuring instrument is stopped.

< backlighting >:

To switch on or off the LCD backlight: The backlight delay can be set in the menu. For more details, see [4.4.2 Backlighting](#).

<Start /Stop>:

To start or stop the measurement.

<▲> :

Use the up arrow to select the menu item or change the parameters.

<▼> :

Use the down arrow to select the menu item or change the parameters.

<◀>:

Use the left arrow to select the menu item or change the parameters or switch between the measurement screens.

<▶>:

Use the right arrow to select the menu item or change the parameters or switch between the measurement screens.

<menu>:

To access the main menu list

2.2 Microphone connection

The TNC connector at the top of the sound pressure gauge is for connecting the microphone and preamplifier (microphone and preamplifier are usually mounted together in one housing). The TNC connector is a threaded coaxial connector.

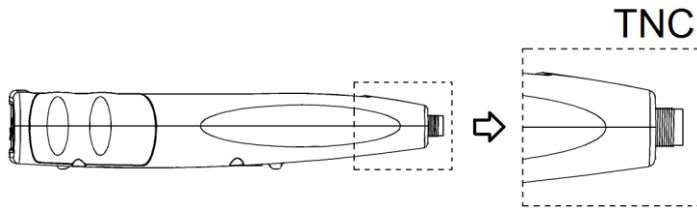

The **SW 1000** measuring instrument is equipped with a class 1 microphone, the **SW 2000** measuring instrument with a class 2 microphone:

SW-A01:

Pre-polarized measuring microphone 1/2", class 1. sensitivity: 50 mV/Pa. Frequency range: 10 Hz to 20 kHz. Common housing with ICCP preamplifier, power supply 4 mA/24 V.

SW-A02:

Pre-polarized measuring microphone 1/2", class 2. sensitivity: 40 mV/Pa. Frequency range: 10 Hz to 12.5 kHz. Common housing with ICCP preamplifier, power supply 4 mA/24 V.

Microphone and preamplifier are screwed together by a thread. Do not separate the parts except in special cases. The microphone is a precision measuring sensor, prolonged contact with high humidity or dusty environments can damage the microphone. When the microphone is not in use, store it in the box provided.

The microphone has an ICCP power supply. The current technical data for the power supply are 4 mA, 24 V. If the voltage exceeds 30 V, the microphone will be damaged. The SW 1000/ SW 2000 sound level meter has an internal ICCD power supply to which the microphone can be connected directly.

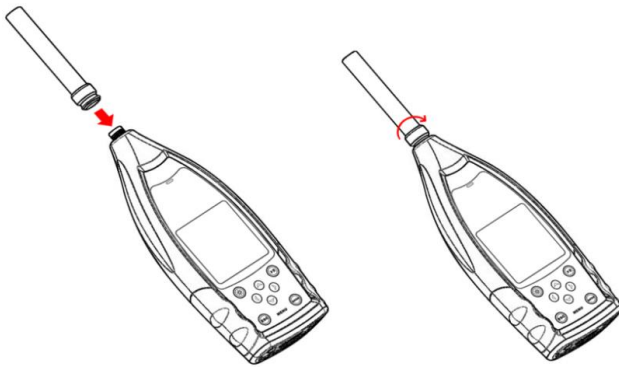

Connect the microphone to the TNC connector. Then turn the thread until the parts are firmly connected.

2.3 Draft shield

The sound pressure meter is equipped with a WS002-9 draft shield for use in windy outdoor areas. The wind shield need not be used if no wind is expected in the surrounding area (for example, when measuring indoors).

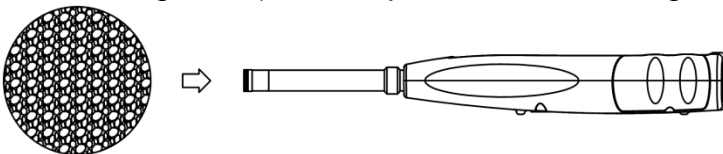

Press the windscreen firmly onto the microphone as shown in the figure above until it stops. See [Appendix 4 for](#) more details on how to adjust the windshield outdoors.

2.4 Data and power supply connection

There are 7 interfaces on the bottom of the sound pressure meter. Open the rubber cover to see these interfaces.

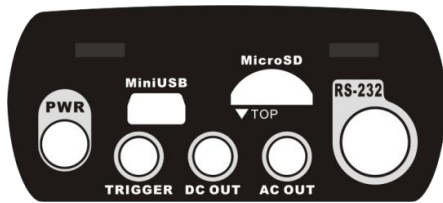

PWR:

Standard DC socket (diameter 2.1 mm) for power supply, can be connected to an external power supply unit 7 - 14 V, 500 mA.

☆Note : External voltages above 14 V can damage the sound pressure meter!

Mini USB:

Mini USB port for connecting to a computer in **USB drive mode** or **modem mode**, see [4.4.10 USB Mode for](#) more information. The Mini USB connector can also be used as an additional external power supply, but the power supply must be capable of handling 5 V/1 A.

USB drive mode: The files on the Micro SD memory card can be accessed directly in this mode, no driver needs to be installed.

The computer can recognize the Mini USB port as a serial port (virtual serial port, driver installation required) and address the sound pressure meter via the RS-232 protocol, for more information see [5](#).

☆ **Note:** The power supply must have a current of at least 1 A and the cable must be able to transmit this current (do not use a cable with ferrite bead for the power supply). After connecting to the computer, select the working mode. Otherwise the computer will not be able to recognize the USB interface. The mini-USB port and the RS-232 port cannot be used simultaneously when the **modem mode** is selected.

Micro SD card:

Micro SD socket: For connecting a Micro SD card for storing SWN, OCT and CSD files. We recommend that you use the card reader to format the Micro SD card and not the **USB drive mode**. The Micro SD card supplied with the sound pressure meter is already preformatted.

☆ Note: Hold the front (with the scratch protection) of the Micro SD card downwards when inserting it.

RS-232:

The interface can be used as a standard RS-232 interface in **remote mode** and for connecting the thermal printer in **printer mode**. For further details, see [4.6.3 Printer](#) and [5th RS-232 data exchange protocol](#).

TRIGGER:

Trigger input with standard 3.5 mm headphone jack. For further details, please refer to [4.4.4 Trigger](#).

DC OUT:

DC voltage output with standard 3.5 mm headphone jack. See [4.6.2 DC voltage output for](#) more details.

AC OUT:

AC voltage output with standard 3.5 mm headphone jack. For more details, see [4.6.1 AC output](#).

2.5 Battery

We recommend the use of 4 alkaline batteries (LR6/AA/AM3); observe the battery polarity (+/-) and the marking in the battery compartment. Do not use old and new batteries together. Remove the batteries when the instrument is not in use. The total voltage of the 4 battery cells must not exceed 14 V, otherwise the sound level meter will be damaged.

Practical tests show that the 4 alkaline battery cells are sufficient for an operation of about 10 hours (depending on the battery). When using Eneloop BK-3HCCA/4BC batteries (nominal capacity 2450 mAh), the sound pressure meter can operate for about 12 hours in continuous operation. If the battery voltage is lower than the minimum voltage of the sound pressure gauge, the gauge will automatically switch off. We recommend the use of an external power supply or power supply via USB for long operation.

Follow the diagram below when inserting or replacing the batteries:

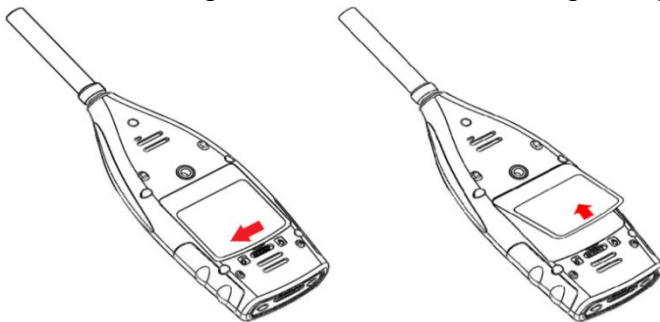

Turn the shutter to the left to remove the battery cover. Lift off the battery cover.

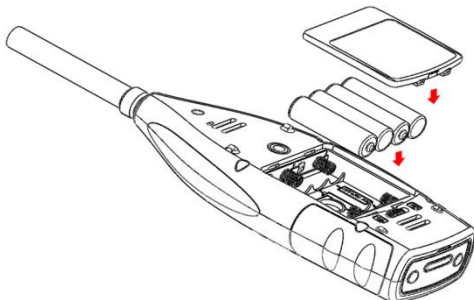

Replace the batteries and close and lock the battery compartment.

2.6 GPS

The GPS antenna is located at the top of the sound pressure meters with GPS option.

☆ Note: Whether the GPS function is required must be known before delivery to the user, otherwise you must send the sound pressure meter to the factory to install the GPS module.

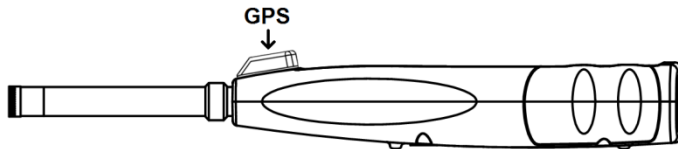

The GPS characteristics are influenced by two factors: the satellite ephemeris and the signal-to-noise ratio of the satellite.

- **Satellite ephemeris:** Orbit information from GPS satellites. The current location can be determined from the ephemeris, the satellite position signal and the time. The satellite ephemeris must be downloaded from the GPS satellite, but the download speed is very low (about 50 bps) and depends on the signal strength of the satellite. The high bit error rate can increase the download time for the ephemeris or cause the download to fail completely. The sound pressure meter can store the ephemeris for about 30 minutes after the GPS module is turned off. The ephemeris is only valid for 2 hours.
- **Signal to noise ratio of the satellite:** The strength of the satellite's position signal. On rainy days or indoors, the signal strength is lower.
The GPS has 3 start modes: cold start, warm start and hot start
- First positioning, the current ephemeris must be downloaded, therefore more time is needed.
- The GPS module has the last stored location information, but has to download the ephemeris again because it is outdated. The warm start takes almost the same time as the cold start.
- The GPS module has valid ephemeris and can determine the position in a very short time.

3. measurement screen

The sound pressure meter has two measuring modes: **level measurement** and **1/1 octave measurement**. The user can select the measurement in the **Function** menu. **The level meter has 8 screens that can be switched with the arrow keys < ◀, ▶ >**. The 8 screens are: Main screen, 3 profiles, LN statistics, time history, customizable measurement page 1, customizable measurement page 2, GPS page 1 and GPS page 2.





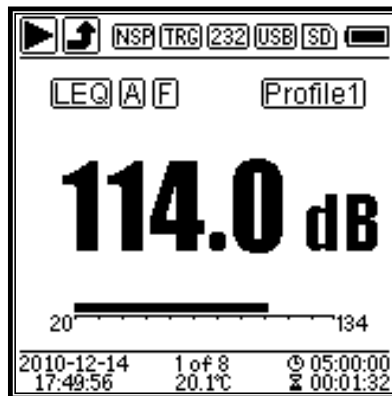















The 1/1-octave measurement has 4 screens: Octave histogram, Octave table Page 1 - 3.

3.1 Symbols and meaning of the screen display



All icons on the main screen are activated, the meaning of the individual icons is described below:

	Start/stop. Describes the measurement status.
	Overload and underrange indication. A permanently displayed arrow indicates that the current status is "Overload" or "Underrange". An arrow that is not filled in indicates that the instrument has fallen below the range during the integral period or that the instrument has been overloaded. When the new integral period begins, the symbol for overload or underrange disappears.
	ICCP status. Displayed when ICCP is switched off.
	Trigger status. Displayed when the trigger is activated.
	Status of the RS-232 interface; the icon is displayed in remote mode , the icon in printer mode.
	Timer status. The symbol indicates that the timer is activated and has only been started once. The symbol indicates that the timer is activated and is started again and again.
	Status of the Micro SD memory. Displayed when the Micro SD memory is activated.

  	Power-up status. The following icons are displayed from left to right: external power, battery power (with voltage indicator) and USB power.
    	Measurement calculation mode
   	Filter status
  	Detector status
	Symbol of the profile. Displays the profile number of the current display.
114.0 dB	Measured value
	Visualization and display of the measured values in the current measuring range as a dynamic bar graph.
2010-12-14 17:49:56	Date and time
1 of 8	Current page number and total page number.
20.1°C	Interior temperature display.
 05:00:00  00:01:32	Symbol  refers to the integral period, symbol  indicates the elapsed time. The measurement stops when the elapsed time is equal to the total measuring time (integral period * repetition).

The symbols in the same row are displayed simultaneously. All icons can appear on any screen and have the same meaning.

3.2 Screen in Level Measurement Mode

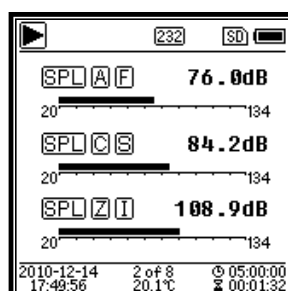
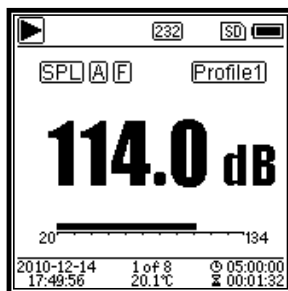

Main screen Displays measurement data, filter, detector, mode and profile number. The main screen shows only one data group of the 3 profiles. Press the arrow keys **<▲>** , **<▼>** to switch **between** the 3 profiles.

3 Profiles Displays the data and the corresponding measurement mode of the filter and detector of the profile measurement simultaneously. Data of the 3 profiles can be stored in a SWN file.

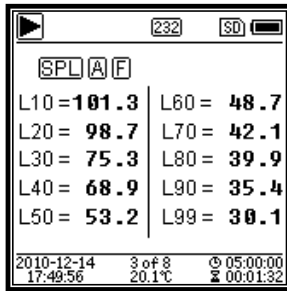

LN Statistics Displays 10 groups with statistical results. Each data source group (fixed mode for SPL, filter and detector can be adjusted) and percentage can be set in the menu.

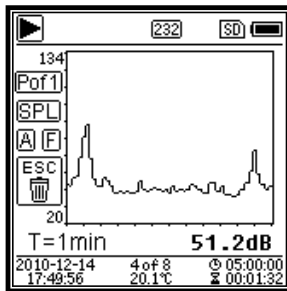

Time history Display of the current noise value and the time domain curve. The data sources (one of the 3 profiles) and the time domain curve (1 minute, 2 minutes and 10 minutes) can be adjusted.

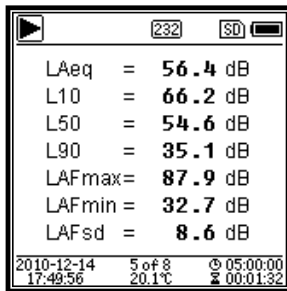

Press <ESC> to clear the screen and display the curve again.

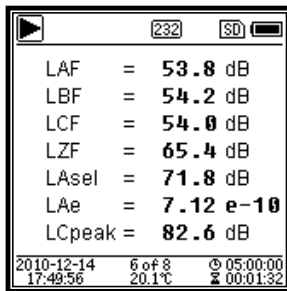

Adjustable measuring page 1. the user can set the parameters of the 14 measuring sets. The first 7 measurement sets can be displayed in this screen.

Adjustable measuring page 2. the user can set the parameters of the 14 measuring sets. The last 7 measurement sets can be displayed in this screen.



GPS Page 1 Display GPS information: GPS status, GPS date, GPS time, longitude, latitude, altitude and speed.

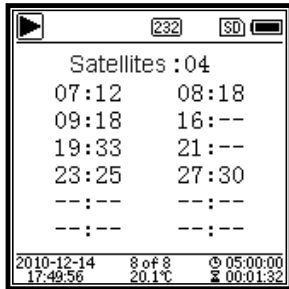

GPS page 2. display the number of satellites for positioning and the signal-to-noise ratio of all visible satellites (0 dB - 99 dB).

★ **Note:** The number of visible satellites may be greater than the number of satellites for positioning because some satellites are not available for positioning.

3.3 Screen of the 1/1-octave mode

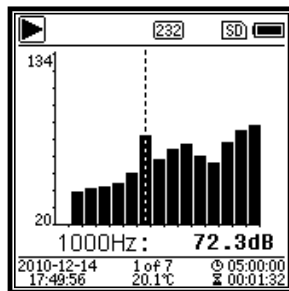

1/1-octave histogram
Displays 10 bands from 31.5 Hz - 16 kHz and LAeq, LBeq, LCeq, LZeq as a bar graph. Press the arrow keys <▲> , <▼> to display the detailed value of each band. A threshold value can be defined for each band. The LED lights red when the data exceeds the threshold.

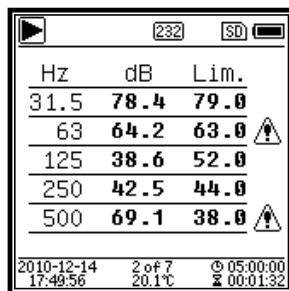

Octave table page 1. display of measured data from 31.5 Hz - 500 Hz. The LED lights red and ⚠ appears when the data exceeds the threshold value.

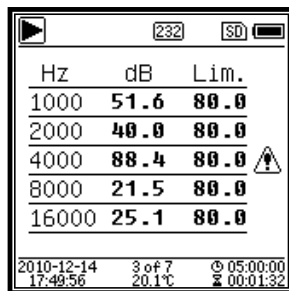

Octave table page 2. display of measured data from 1 kHz - 16 kHz. The LED lights red and ⚠ appears when the data exceeds the threshold value.

Leq	dB	Lim.
LeqA	48.6	80.0
LeqB	50.1	80.0
LeqC	68.4	80.0
LeqZ	81.4	80.0
2010-12-14 4 of 7 05:00:00 17:49:56 20.1°C 00:01:32		

Octave table page 3. display of the measured data of LAeqLBeq, LCEq and LZeq. The LED lights red and  appears when the data exceeds the threshold value.

4. operation and setting of the menu

Menu
Function
Calibration
Measurement
Setup
Language
Output
Factory Settings

Press the <Menu> button **to** enter the next menu. All measurement parameters can be set in the menu.

Structure menu:

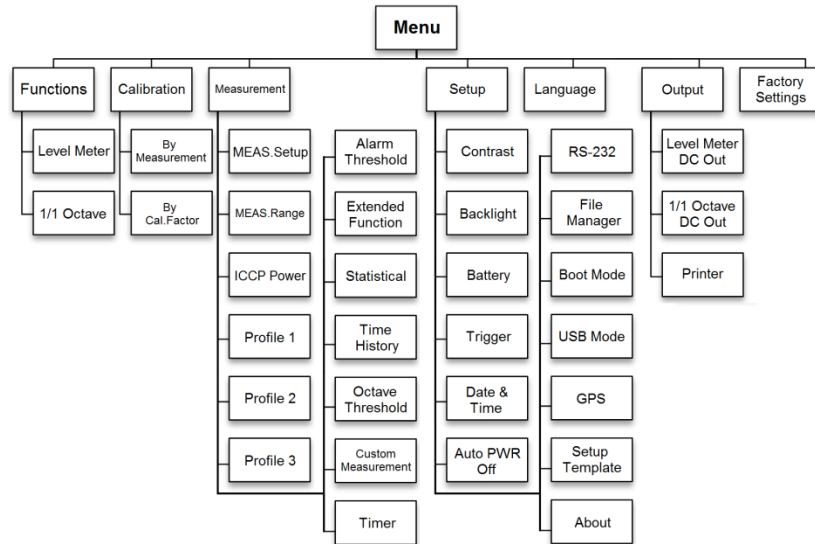

4.1 Function

Function
Level Meter
1/1 Octave

Select the **function** and press the < Enter> button to enter this menu. You can select 2 measurement types: **Level measurement** and **1/1 octave measurement**. Press the arrow keys <▲>, <▼> to select the measurement mode. Press the <Enter> button to save the setting and return to the previous menu. Press the <ESC> button **to** return to the previous menu.

4.2 Calibration

Calibration
By Measurement
By Cal.Factor

Select the **Calibration** option and press the < Enter> button to enter this menu.

The sensitivity of the microphone is influenced by numerous factors, such as temperature, humidity and air pressure. Therefore, the user must perform at least one calibration prior to measurement.

There are two calibration procedures. **By measurement** and **With calibration factor**. For calibration with the sound calibrator, the method **By**

measurement should be used. The **With calibration factor** calibration procedure allows the user to manually adjust the calibration factor.

4.2.1 Calibration by measurement

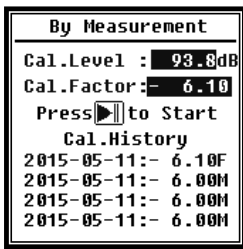

Select the **By Measure** option and press the <Enter> button to enter this menu. See Chapter 7 for more details on the specified calibrator and its corresponding adjustment values.

The calibration level can be adjusted between 0 dB and 199.9 dB. Press the arrow keys <◀>, <▶> and <▲>, <▼> to change the calibration level and the <Start> key to start the calibration. When calibration is complete, the new calibration factor is updated and the user can press the <Enter> or <ESC> key to save or ignore the result. This menu also displays the calibration history. Entries with the **M** symbol at the end indicate that the data set has been calibrated using the **By Measurement** procedure.

4.2.2 Calibration with calibration factor

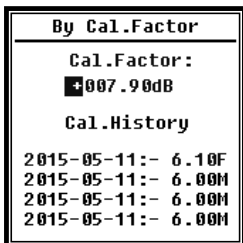

Select the **With calibration factor** option and press the <Enter> button to enter the menu.

Users can manually adjust the calibration factor. Use the arrow keys <◀>, <▶> to select the factor number, use the arrow keys <▲>, <▼> to select the value, save it with the <Enter> key and return to the last menu with the <ESC> key. An entry with the end **F** indicates that the data set was calibrated with the method **With calibration factor**.

4.2.3 Conversion of calibration factor and sensitivity

The sensitivity can be calculated with the following formulas. The calibration factor can also be calculated from the sensitivity and entered directly into the sound pressure meter.

$$Cal.F = 20 * \log (Sens / 50) + offset$$

$$Sens = 50 * 10^{((calibration\ factor\ offset) / 20)}$$

Here is:

Cal.F is the calibration factor in decibels (dB);

Sens the sensitivity of the microphone in mV/Pa;

Offset the calibration factor in decibels (dB). This value is the calibration result with the method **By measurement** with a signal of 50 mV. This offset is the device-specific deviation, which is different for each sound pressure measuring instrument.

4.2.4 Calibration by measurement

Calibration by measurement is the recommended calibration procedure using a sound calibrator. KERN can supply sound calibrators of class 1 and 2 according to the standards GB/T 15173-2010 and IEC60942: 2003.

Proceed as follows for calibration by measurement:

1. Insert the microphone into the cavity of the calibrator as far as it will go; the microphone must be tight.

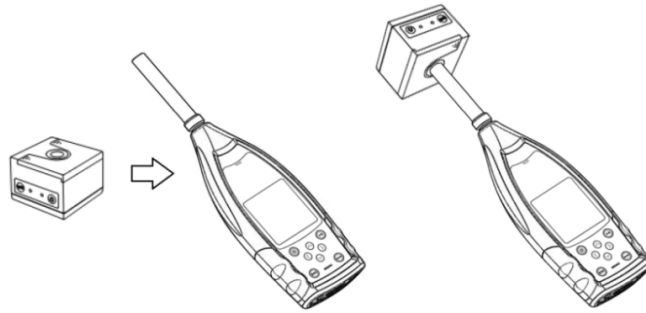

2. Then switch on the calibrator and set a constant sound level (for example 94 dB).

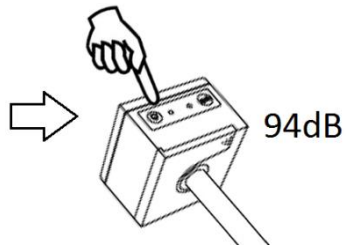

3. **Select Calibration** from the menu and press <Enter> to enter the **By Measurement** menu.

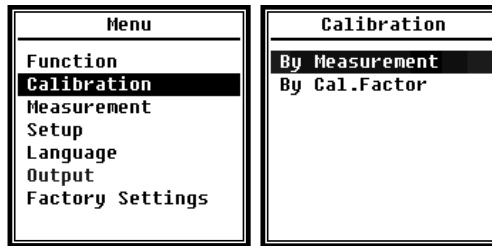

4. Set the value for **Cal.Level** in the menu, for example to 93.8 dB. Calibration is performed 5 seconds after pressing the <Start> button.

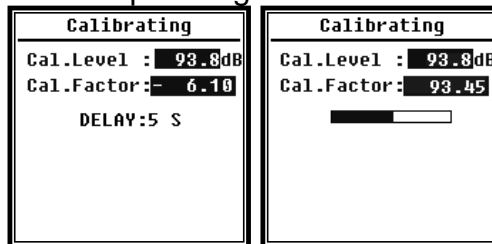

5. When the calibration is finished, the sound pressure meter updates the calibration factor. Press the <Enter> button to accept the results.

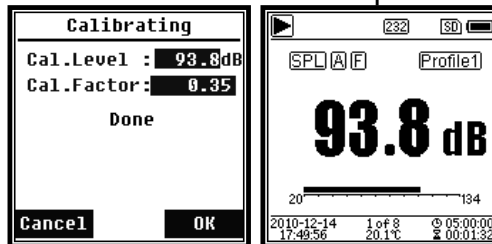

6. Go back to the **main screen** and press <Start/Stop> to start the measurement. The current measurement result in this example is 93.8 dB if the calibrator is in good working order.

4.3 Measurement

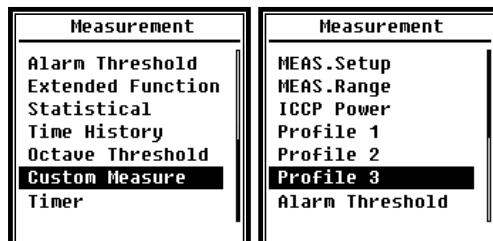

There are 13 menu options in the **Measurement** menu. Use the arrow keys <▲>, <▼> to select options and press <Enter> to move to the next menu.

4.3.1 Measurement setup

MEAS.Setup	
Delay	: 1s
Itg.Period	: Inf
Repeat	: Inf
SWN Logger	: [*]
SWN Log.Step:	1s
CSD Logger	: [*]
CSD Log.Step:	1m

The **MEAS.setup** menu is the most important menu for the measurement. Here you can set the parameters for **delay**, **integration period**, **repeat**, **SW protocol step**, **SWN protocol step**, **CSD protocol** and **CSD protocol step**. You can select options with the arrow keys <▲>, <▼>.

▷ Delay (Delay):

The delay time between pressing the <Start> key **and** the start of the measurement. With the arrow keys <◀>, <▶> you can select the delay time as follows Sync 1 min, Sync 15 min, Sync 30 min, Sync 1 h, 1 s to 60 s.

The delay time prevents the measurement from being influenced by the keystroke or by vibrations.

Itg. period (integral period):

Itg.Period is the integral period for each individual measurement. At the beginning of each integral period, all integral data and time data are reset; the indication of an overload or underrange is deleted. Integral data and time data are LEQ, Max, Min, Peak, SD, SEL, E and LN. Press <◀>, <▶> to select the following option: Infinite, 1 s to 59 s, 1 min to 59 min, 1 h to 24 h.

Repeat:

The number of repetitions in a measurement. Total measuring time = **integral period** x **repetition**. Press <◀>, <▶> to select the following option: Inf, 1 through 9999.

SWN Logger (SWN Protocol):

Press the arrow keys <◀>, <▶> to switch over. When you select this option, the sound pressure meter saves the data in SWN/OCT files.

The SWN/OCT files store the time history data. The data source in **Sound Pressure Gauge Mode** is Profile 1 - 3 (selected in the SWN Save option of the Profile 1 - 3 menu); the data is saved as an SWN file. In 1/1 octave mode, all octave bands as well as LAeq, LBeq, LCeq, LZeq are saved as an OCT file.

SWN Log Step (SWN log step):

SWN Log Step (SWN log step) is the log step (the interval time) for storing data as SWN/OCD time. Press <◀>, <▶> to select the following option: 0.1s, 0.2s, 0.5s, 1s to 59s, 1min to 59min, 1h to 24h CSD Logger  **protocol**):

Press the arrow keys <◀>, <▶> to switch over. When the appropriate option is selected, the sound pressure meter saves the results in CSD files.

CSD-files save the current data. The data source in the **sound pressure meter mode** are the 14 group results of the **adjustable measurement**; these are stored as CSD files. In the 1/1 octave mode, all octave bands as well as LAeq, LBeq, LCeq and LZeq are saved as a CSD file.

☆ Note: After selecting the appropriate option, press <Enter> **on** the main screen to manually save the data to the CSD file when the measurement is stopped.

CSD Log.Step (CSD log step):

CSD Log.step (CSD log step) is the log step (the interval time) for saving the data as CSD file. Press <◀>, <▶> to select the following option: 1s to 59s, 1min to 59min, 1h to 24h.

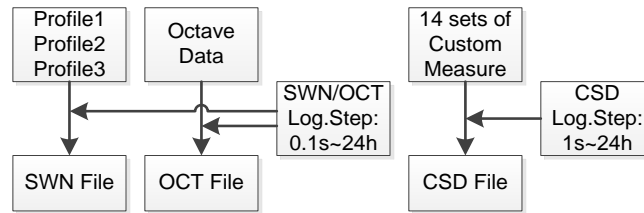

☆ **Note:** A SWN/OCT file can only store integral data. The logging step can be considered as an integral period. All data within the logging step (the integral period) is saved as one line in the SWN/OCT file. The CSD file only saves instantaneous data without integration. As soon as the CSD logging step is reached, the 14 group data of the adjustable measurement are saved as a line in the CSD file like a snapshot.

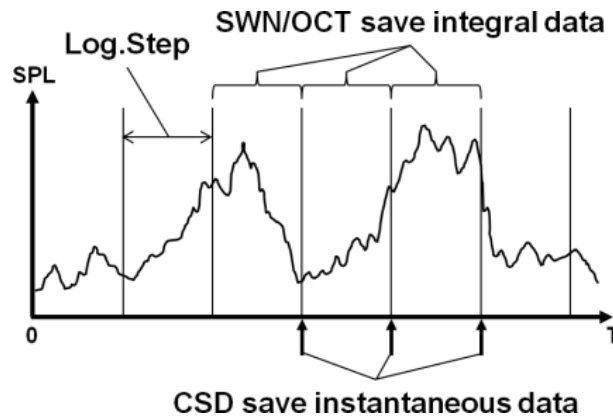

4.3.2 Measuring range

MEAS. Range
Linearity Range: 20.0dB A - 134.0dB A
Dynamic Range: 11.0dB A - 134.0dB A
Peak C Range: 45.0dB A - 137.0dB A

The **MEAS.Range** menu shows the **linearity range**, the **dynamic range** and the **peak C-range**.

Due to the newly developed algorithms, there is only one measuring range; the measuring range no longer needs to be switched. The algorithm meets the requirements for a pulse frequency response of up to 0.25 ms with an error of only 0.1 dB at 4 kHz. For pulse trains of 0.125 ms at 4 kHz, the error is 0.4 dB.

▷ **Linearity range:** The measurement result can only be considered correct if the result is within the linear range. Otherwise the measurement error of the measurement result is above the acceptance limit. Sometimes the linearity range is also referred to as the "measurement range".

Dynamic Range: The dynamic range is the range between the inherent noise and the maximum input signal level. The dynamic range is the maximum range that the sound level meter can display. The measurement result close to the inherent noise does not have to be considered linear.

Peak C Range: The Peak C Range is the linear range of the Peak C measurement. The Peak C measurement in this range can be considered correct.

4.3.3 ICCP Power Supply

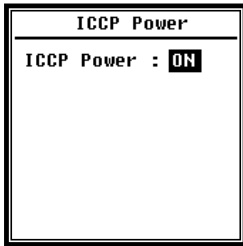

The ICCP menu controls the power supply of all ICCP sensors via the 24 V/4 mA constant current source. Disable the ICCP power supply before connecting another sensor or connecting directly to the signal source. Press the arrow keys <◀>, <▶> to select.

4.3.3 Profiles 1 to 3



The menu for the profiles 1 - 3 allows the definition of the filter, the detector, the mode and the storage options of SWN files. Options can be selected with the arrow keys <▲>, <▼>.

▷Filter:

Define the filter for Profile 1 - 3 Press <◀>, <▶> to select the following option: **A**, **B**, **C** and **Z** (Z weighting means "no weighting". It is sometimes referred to as "blanket" or "linear" weighting).

▷Detector:

Define the detector of profile 1 - 3 Press <◀>, <▶> to select the following option: **Fast**, **Slow** and **Pulse**.

▷mode:

Defines the integral mode of Profile 1 - 3 Press <◀>, <▶> to select the following option: **SPL**, **PEAK**, **LEQ**, **MAX** and **MIN**.

SWN Save:

With this option you define which data should be stored in the SWN file, since the data source of the SWN file is Profile 1 - 3. This option has no relation to the screen display. Press <◀>, <▶> to select the following option: **LEQ**, **PEAK**, **MAX** or **MIN**.

4.3.5 Alarm threshold



If measurement results of profile 1 - 3 exceed the **alarm threshold**, the LED above <Power> will light **red**. The alarm threshold can be set between 20 dB and 200 dB. Use the arrow keys <▲>, <▼> to increase or decrease the alarm threshold by 1 dB. Use the arrow keys <◀>, <▶> to increase or decrease the setting by 10 dB.

4.3.6 Extended function

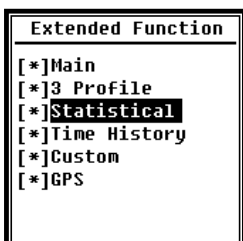

With the advanced function, you can set which screen is displayed. If the screen is not selected, it is not displayed. Note that the **Main Menu** screen is always displayed.

4.3.7 Statistics

Statistical		Statistical	
LN4	: 40	Mode	: SPL
LN5	: 50	Filter	: A
LN6	: 60	Detector	: Fast
LN7	: 70	LN1	: 10
LN8	: 80	LN2	: 20
LN9	: 90	LN3	: 30
LN10	: 99	LN4	: 40

The data source for the statistics is permanently set to SPL. The user cannot change this setting. However, the user can define the filter and detector for SPL and the statistics value using this menu.

▷mode:

The setting is permanently assigned to SPL and cannot be changed.

▷Filter:

You can define the filter for the statistical analysis with the arrow keys <◀> , <▶> : **A**, **B**, **C** and **Z** (linear).

▷Detector:

Use the arrow keys <◀> , <▶> to set the detector for statistical analysis: **Fast**, **Slow** and **Imp**.

LN1 TO LN10:

With the arrow keys <◀> , <▶> you can define the percentage of the 10 LN groups from 1% - 99%.

Example: **LN1:10 = 80 dB** means that in the integral period 10% of the measured data are above 80 dB. The LN result depends on the integral period. The result is reset when a new integral period begins.

4.3.8 Time history

Time History	
Profile	: 1
Duration	: 1min

Use the arrow keys <▲> , <▼> to set the data source and the duration of the time course.

▷Profile:

With the arrow keys <◀> , <▶> you can set the data source of the time history: **Profile 1**, **Profile 2**, **Profile 3**.

▷Duration:

You can set the time axis of the time curve with the arrow keys <◀> , <▶> . **1** minute, **2** minutes, **10** minutes.

4.3.9 Octave threshold

Octave Threshold		Octave Threshold	
250Hz	: 044.0	LeaA	: 038.0
500Hz	: 038.0	LeqB	: 038.0
1000Hz	: 079.0	LeqC	: 038.0
2000Hz	: 063.0	LeqZ	: 079.0
4000Hz	: 052.0	31.5Hz	: 063.0
8000Hz	: 044.0	63Hz	: 052.0
16000Hz	: 038.0	125Hz	: 044.0

The **Octave Threshold** menu allows you to set the alarm threshold from 31.5 Hz - 16 kHz and LAeq, LBeq, LCEq and LZeq. If the measurement result exceeds the threshold, the LED lights up red. With the arrow keys <◀> , <▶> you can set the option between 0.1 dB and 199.9 dB.

4.3.10 Adjustable measurements

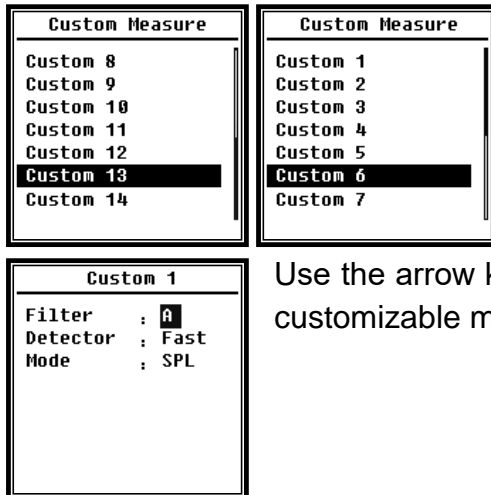

There are 14 **adjustable measurement** menu options where you can define the parameters for 1 - 14 adjustable measurements. Use the arrow keys <▲> , <▼> to select the option and press <Enter> to move to **the next menu level**.

Use the arrow keys <▲> , <▼> to set an option for each group of customizable measurements: **Filter, Detector and Mode**.

▷Filter:

Use the arrow keys <◀> , <▶> to set the filter for adjustable measurements: **A, B, C** and **Z** (linear).

▷Detector:

Use the arrow keys <◀> , <▶> to set the detector for adjustable measurements: **Fast, Slow** and **Imp**.

▷mode:

Use the arrow keys <◀> , <▶> to set the integral mode for adjustable measurements: **SPL, SD, SEL, E, Max, Min, Peak, LEQ, LN1 to LN10**.

4.3.11 Timer



In the Timer menu you can set the options **Start Day, Start Time** and **Repeat Interval** for the **timer**. Press the arrow keys <▲> , <▼> to select.

To start measurements with a program, a new function called **Timer** was introduced. The user can program the measurement to start at 00:00 the next day, take several minutes of measurements and repeat every hour to achieve an automatic measurement over 24 hours.

▷Timer:

Use the arrow keys <▲> , <▼> to **set** the working mode of the timer: **OFF, one time** and **loop**.

▷Start Day (start day):

Use the arrow keys <▲> , <▼> to **set** the trigger date for timers : Ignore and one fixed day every 30 days. If you select Ignore, the **timer** ignores the date and uses only the **start time** to trigger.

▷Start Time (start time):

Use the arrow keys <▲> , <▼> to **set** the time for the timer: 00:00~23:59

Repeat Period (repetition time):

If the **timer** is triggered, it will be retriggered each time the **repeat time** has elapsed. Press <◀> , <▶> to select the following option: 1 min~59 min, **1 h ~ 24 h**.

☆Note : The **repetition time** must be greater than the total integral time (**integral time** x **repetition**) + 5 s, because a fixed delay of 3 s is set for the **timer** when measurement is triggered and 2 more seconds are required before the delay. You must not change the settings when the **timer is** running. Otherwise the **timer** is defective.

4.3.12 24 h measurements with timer

The user can use the **timer** to implement a 24-hour measurement. The following description uses an example to show how to implement the 24-hour measurement.

MEAS.Setup	
Delay :	1s
Itg.Period :	5m
Repeat :	1
SWN Logger :	[*]
SWN Log.Step :	1s
CSD Logger :	[*]
CSD Log.Step :	5m

Purpose: The measurement starts first on 14 March 2015 00:00 and measures the first 5 min of each hour. The measured values are stored in the CSD file when the measurement stops and every second in the SWN file.

The delay setting in MEAS.setup is ignored if the measurement is triggered by the timer. Set **Itg.Period** to **5 min** and **Repeat** to **1**.

Activate SWN protocol and CSD protocol. Set the SWN protocol step to 1s and the CSD protocol step to 5 min.

Timer	
Timer :	Loop

Start Day	
Start Day :	2015-3-14

Set the **timer** to **loop mode** so that the measurement is triggered again and again.

Set the desired date as **Start Day**.

Start Time	
Start Time :	00:00

Repeat Interval	
Repeat Interval :	1h

Set the Start Time as **00:00**. This is the time at which the measurement is triggered for the first time.

Set the **Repeat Interval** to **1 h** so that the measurement is triggered every hour.

4.4 Setup

The **setup** menu contains the basic setup and condition display functions. Use the arrow keys <▲> , <▼> to select the option and press <Enter> to move to the **next menu level**.

Setup	
Contrast	
Backlight	
Battery	
Trigger	
Date & Time	
Auto PWR OFF	
RS-232	

Setup	
RS-232	
File Manager	
Boot Mode	
USB Mode	
GPS	
Setup Template	
About	

4.4.1 Contrast

The **Contrast** menu allows you to adjust the contrast of the LCD display in 14 levels. Press the arrow keys <▲> , <▼> to select.

Contrast	
Min	Max
████████████████████	

4.4.2 Backlighting

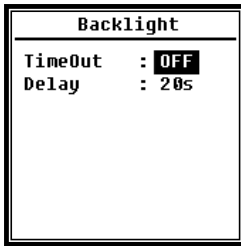

The sound pressure meter automatically turns off the backlight to reduce power consumption and save battery life.

In the Backlight menu, you can enable or disable the power off and change the delay time for the backlight. Press the arrow keys <▲>, <▼> to select.

4.4.3 Battery

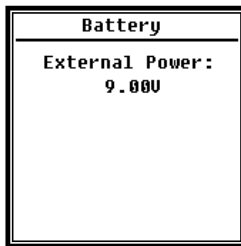
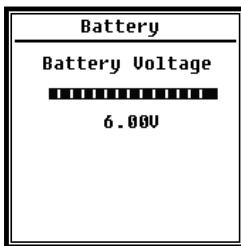

The **Battery** menu displays the battery status and voltage.

The final discharge voltage of a single alkaline battery cell LR6/AA/AM3 is approx. 0.9 V, therefore the sound pressure meter switches off automatically when the total voltage of the 4 cells

of the alkaline battery falls below 3.6 V.

4.4.4 Trigger

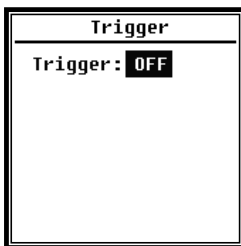

In the **Trigger** menu you can switch the function of the trigger on and off. The **trigger** is an analog input with which you can start or stop the measurement for the sound pressure meter by remote control. The trigger input is located on the bottom of the sound pressure meter (headphone jack 3.5 mm).

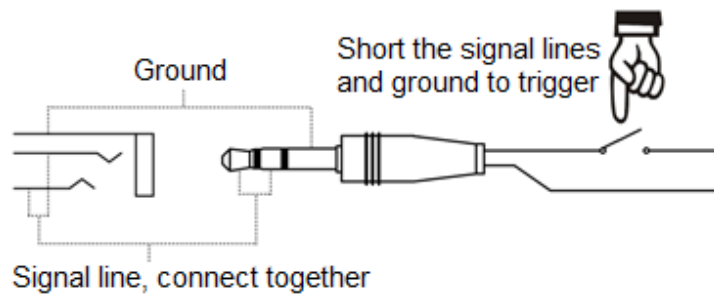

The measurement is started by connecting the signal line to ground and stopped by interrupting it. Note that when the **trigger function is** activated, the <Start/Stop> **button** is not available.

4.4.5 Date & Time



In the **Date & Time** menu the RTC time of the sound pressure meter can be set. Press the arrow keys <▲>, <▼> to select.

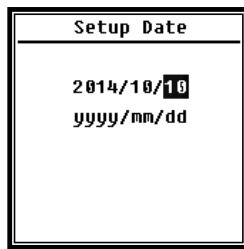
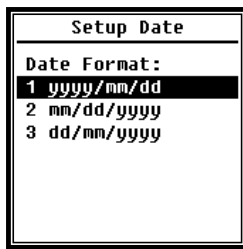

With the arrow keys <▲> , <▼> you can select the date format and change the date. With the arrow keys <◀> , <▶> **you can** select the year, month and day, and with the arrow keys <▲> , <▼> you can modify their value. Press <Enter> **to save the setting.**

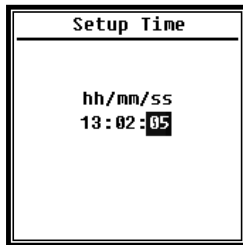

Changing the time setting is similar. Use the arrow keys <◀> , <▶> **to** select hour, minute and second and use the arrow keys <▲> , <▼> to modify the value. Press <Enter> **to save the setting.**

The voltage supply for RTC is provided by an internal buffer battery. Replace the RTC battery if the sound pressure meter forgets the date and time because the voltage of the RTC battery is too low.

Tips for replacing the RTC battery: Loosen the 5 screws on the back of the sound pressure meter so that you can remove the cover. The RTC battery is located on the circuit board as shown in the following figure The battery is a CR-1220 button cell.

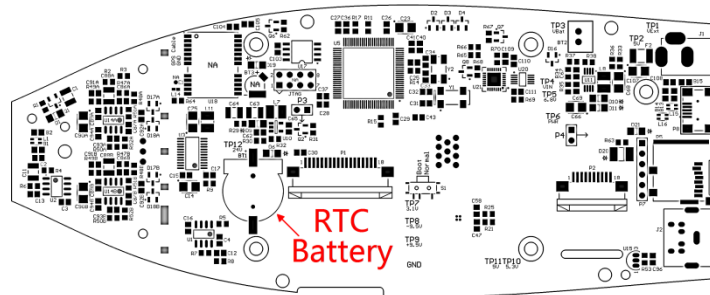

☆Note : The system clock of the sound level meter was calibrated with a reference clock with an average error of 2 ppm (maximum error 3 ppm). The time accuracy is less than 10 ppm at room temperature (<26 seconds within 30 days). The maximum time error for internal tests at 25 °C was about 5 to 8 seconds.

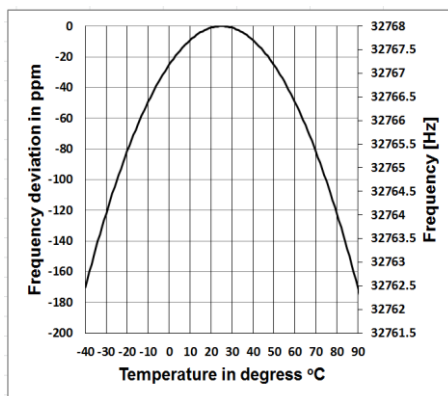

The accuracy of the system clock may vary depending on the temperature, as there is no temperature compensation. With the typical temperature curve in the illustration, the system clock does not change its base frequency. If the temperature rises or falls, the frequency of the system clock changes by about $-0.04 \text{ ppm}/^\circ \text{C}^2$. Therefore, if the temperature is 0°C , the value for the system clock changes by $-0.04 \times (0-25)^2 = -25$

ppm, which corresponds to a delay of 2.16 seconds per day. When the temperature is 40°C , the value of the system clock change is $-0.04 \times (40-25)^2 = -9$ ppm, which corresponds to a delay of 0.78 seconds per day.

The maximum error (<10 ppm) specified in the user manual can be calculated as an approximately 16°C difference from the reference temperature of 25°C . The system clock RTC can therefore keep the error below 26 seconds within 30 days between 9°

C and 41 ° C, i.e. at room temperature. The real RTC error can be greater than the value specified in the user manual if the temperature range is exceeded.

4.4.6 Automatic switch-off

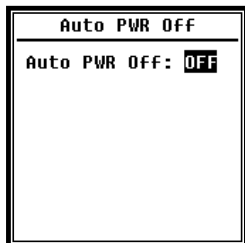

The sound level meter has an automatic switch-off function to reduce power consumption. If the sound level meter remains in stop status and no button is pressed for a certain period of time, the instrument will shut down according to this setting. The following settings are available for the auto power off option: **1 minute, 5 minutes, 10 minutes, 30 minutes, Off**. Press the arrow keys < ◀ ▶ > , < ▶ ▶ > to select. Press < Enter > to save the setting.

, < ▶ ▶ > to select. Press < Enter > to save the setting.

4.4.7 RS-232 interface

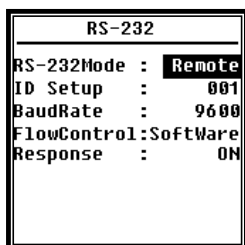

The RS-232 interface menu is used to set the options for the serial connection, see 5. [RS-232 data exchange protocol](#).

▷ Mode of the **RS-232** interface:

RS-232 remote option, printer. Use the arrow keys < ◀ ▶ > , < ▶ ▶ > to select. The sound level meter can send and control data via the RS-232 port in **remote mode**. The RS-232 port can be used to connect to a thermal printer (optional) in **printer mode**.

▷ **ID setup**:

In the **ID setup** (see [5.2.2 Device ID for](#) more information) you can set the ID number to distinguish between several sound level meters in the network. You can set the ID between 1 and 255. Press the arrow keys < ◀ ▶ > , < ▶ ▶ > to select.

▷ **Baud rate**:

The **baud rate** (for more details, see section [5.1 Hardware configuration and interface settings](#)) defines the speed for data exchange via the RS-232 interface: **4800 bps, 9600 bps, 19200 bps**. Press the arrow keys < ◀ ▶ > , < ▶ ▶ > to select.

▷ **The following options are supported**:

Data flow control: (See [5.2.7. Data flow control](#)) With the data flow control you can set the data flow mode on remote control. The options are: **Hardware, Software**. Press the arrow keys < ◀ ▶ > , < ▶ ▶ > to select.

▷ **Answer**:

Answer (see [5.3 Instructions for](#) further information). This allows you to enable or disable the response signal (ACK/NAK). The options are: **ON, OFF**. Press the arrow keys < ◀ ▶ > , < ▶ ▶ > to select.

4.4.8 File Manager

```

File Manager
SWN File : 22
OCT File : 7
CSD File : 32
  
```

You can use the **file manager** to manage the saved SWN, OCT and CSD file. The numeric display on the right side of each line is the file counter for each file type. Use the arrow keys <▲> , <▼> to select the option and press <Enter> to move to the next menu level .

```

SWN File
Select : 001/006
Option : Delete
File:
DATA0001.SWN
Cancel Ok
  
```

```

SWN File
Select : 000/006
Option : Delete
File:
All Files
Cancel OK
  
```

In the **SWN File** menu, you can delete SWN files using the arrow keys <▲>, <▼>. Select the file number you want to delete. The complete file name is displayed at the bottom of the screen. Select 0000 for the file number if the entire existing SWN file can be deleted.

```

OCT File
Select : 0001/0006
Option : Delete
File:
DATA0001.OCT
Cancel Ok
  
```

```

OCT File
Select : 0000/0006
Option : Delete
File:
All Files
Cancel OK
  
```

In the **OCT File** menu, you can delete the OCT file. The operation is the same as in the **SWN file** menu.

```

CSD File
Select : 0001/0006
Option : Delete
File:
DATA0001.CSD
Cancel Ok
  
```

```

CSD File
Select : 0000/0006
Option : Delete
File:
All Files
Cancel Ok
  
```

The CSD File menu allows you to delete, display and print the CSD file. **You can move** the cursor between Select and Option using the arrow keys <▲> , <▼> . Deleting is done in the same way as in the **SWN File** menu.

```

CSD File
Select : 0001/0006
Option : View
File:
DATA0001.CSD
Cancel Ok
  
```

```

CSD File
Select : 0001/0006
Option : Print
File:
DATA0001.CSD
Cancel Ok
  
```

Select **Option from the CSD File** menu, then press the arrow keys <◀>, >▶> to display or print the CSD file.

After selecting the file number and action, press <Enter> to display or print the contents of the file.

```

DATA0002.CSD
[ST]2014-10-13
11:31:37
[DT]0000:00:20
[DATA]
LAFmin 040.7
LApeak 104.7
LAsel 074.8
LAF 049.7
  
```

```

DATA0002.CSD
[ST]2014-10-13
11:31:37
[DT]0000:00:20
[DATA]
LBF 054.4
LAFsd 008.6
LBFsd 008.2
LAe 3.422e-06
  
```

Use the arrow keys <▲>, <▼>, <◀>, >▶> to browse the file contents in display mode. The **print mode** is almost identical to the **display mode**. Press the <Enter> button to print the currently displayed contents of the CSD file.

4.4.9 Boot mode

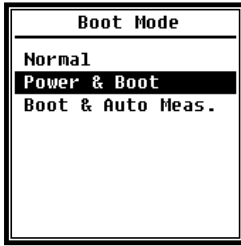

In **Start mode**, use the arrow keys <▲>, <▼> to select **Normal**, **Power & Boot**, and **Boot & Auto Meas.** (Switch on and Auto Meas.).

☆Note : The switch for the hardware mode in the battery compartment must be set according to the start mode.

▷Normal:

You must set the hardware switch for the mode to **Normal**. This is the normal operating mode of the sound level meter.

Power and Boot (switching on and starting):

In this case you must set the hardware switch for the mode to **Boot**. After selecting this mode, the sound level meter will turn on as soon as a suitable power supply is available. The device can be integrated into another system, especially if a power failure is expected. The sound level meter automatically switches on again after a power failure.

Boot and Auto Meas. (Start and Auto Meas.):

In this case you must set the hardware switch for the mode to **Boot**. If you select this mode, the sound level meter not only turns on as soon as the operating voltage is applied, but also starts measuring. If the sound level meter has been integrated into another system, it switches on and starts measuring automatically after a power failure.

Hardware mode switch:

The hardware switch for the mode is located in the battery compartment. It is easily accessible after removing the batteries. Slide the switch to the "Boot" or "Normal" position using pliers or a pen.

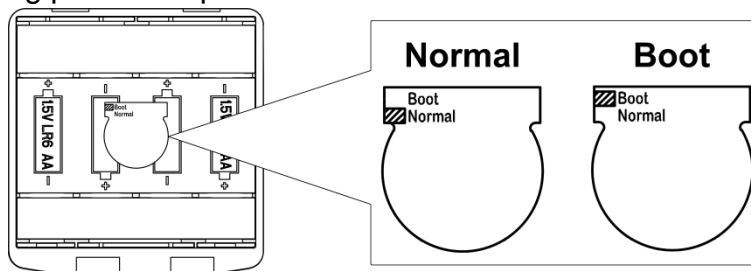

☆Note : This area is sensitive to electrostatic charges. Avoid electrostatic charges before operation.

4.4.10 USB mode



The **USB Mode** menu allows you to set the working mode when you connect the sound level meter to the computer with a USB cable. **Always Ask**, **USB Disk Mode** (USB drive) and **Modem Mode** are available for selection.

Always Ask:

The device always asks back which mode to select when connecting the USB cable to the computer. Please consider in time which option you want to use, otherwise the computer will not recognize the sound level meter due to time overflow.

USB Disk Mode (USB drive):

The device always operates in **USB** Disk Mode (USB drive mode) without any query when connected to the computer via the USB cable. The sound level meter can be recognized by the computer as a removable USB drive without driver installation. The files in the Micro SD card can be accessed directly using Windows Explorer.

Modem Mode (Modem Mode):

In this case, when connected to a computer via the USB cable, the device always operates in **modem mode** (modem mode) without query. The sound level meter can be recognised by the computer as a serial port (virtual port) and uses the same protocol as the RS-232 interface (for further details see [5. RS-232 data exchange protocol](#)).

4.4.11 GPS

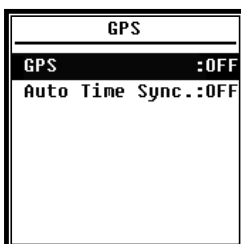

In the **GPS** menu you can enable or disable the **GPS** and **Auto Time Sync** options. When the **GPS** is disabled, the internal GPS module is turned off. The system clock of the sound level meter will synchronize with GPS time if you enable the **Auto Time Sync** option.

4.4.12 Setup template

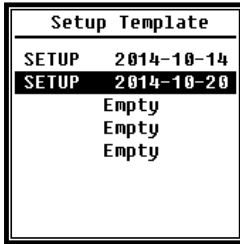

The setup template allows you to save five user group setting parameters of the sound level meter for different applications.

☆Note : The template does not change the calibration factor. Do not try to load the template of the old version into the firmware of the new version, because certain modifications of the template format may be present.

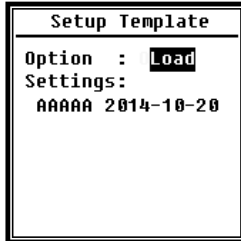

Press the <Enter> button **when the** template is empty. The template can store a group setting for which the user can specify a five-letter or numbered label.

Press the <Enter> button **if** a template exists to load or delete it.

4.4.13 About

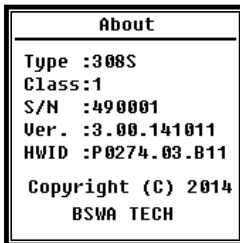

The About menu displays the type, class and serial number, version and HWID (hardware ID) of the sound level meter.

4.5 Language



The sound level meter supports six languages: **English, Chinese, Portuguese, Spanish, German** and **French**. Use the arrow keys <▲> , <▼> to select the appropriate language and press <Enter> to save **the setting**.

4.6 Output (output)

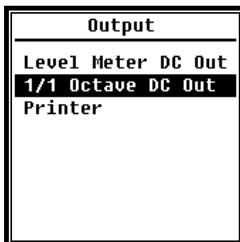

For the **Output** menu, you can select which measurement data are to be output at the **DC voltage output**. For **Level Meter Mode** and **1/1-octave mode**, there are Level Meter DC Output and 1/1-octave DC Output options.

The Printer option is also included in this menu. Press the arrow keys <▲> , <▼> to select.

4.6.1 AC OUT (alternating voltage output)

There are two analog outputs on the sound level meter: **DC output** and **AC output**. Connect the **DC output** or **AC output** to the other device or system using coaxial cables. The input impedance of the termination device or system should be approximately 5 kΩ.

The connection for the **AC voltage output is located on the** bottom of the sound level meter. It outputs the signal from the microphone directly without any adjustment possibility. The maximum output voltage is 5 V_{rms} (±7 V peak) and the maximum output current is ±15 mA.

☆Note : If the input resistance of the termination device or system is not high enough, you will need to add an impedance matching circuit. The **AC output** can only be used for noise recording or monitoring because the background noise is higher than the lower limit of the linear measurement range of the sound level meter.

4.6.2 DC OUT (direct voltage output)

The **DC voltage output** is used to output the analog DC voltage signal, which is proportional to the measurement result with a ratio of 10 mV/dB. For example, at 93.8 dB the output will output 938 mV. This option is recommended for filtering or averaging the output signal to eliminate noise.

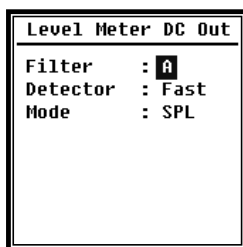

The **DC output** of the level meter can set the signal output for the level meter mode. Press the arrow keys <▲> , <▼> , <◀> , <▶> to select.

Filter: A, B, C, Z (flat)
Detector: Fast, slow, Imp.
Mode: SPL, LEQ, Peak

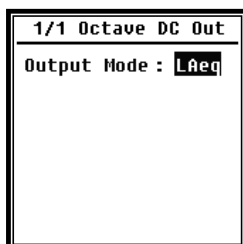

1/1 Octave DC Out defines the output signal in 1/1 octave mode. The following options are available: LAeq, LBeq, LCeq, LZeq, 31.5 Hz, 63 Hz, 125 Hz, 250 Hz, 500 Hz, 1 kHz, 2 kHz, 4 kHz, 8 kHz, 16 kHz. Press the arrow keys <◀> , <▶> to select.

4.6.3 Printers

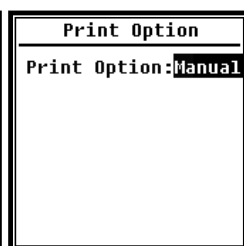
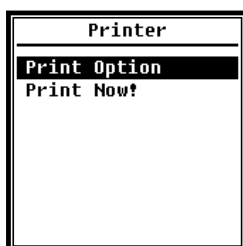

The **Print** option allows you to set the printer to print automatically or manually. If you select the **Auto** option, measurement results are printed automatically after the measurement stops.

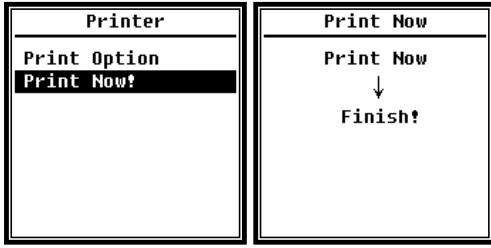

If the user selects the **Manual** option, the user must click **Print Now** and **press** the <Enter> key to print the measurement data.

☆Note : Switch to the **Printer** mode in the **RS-232** menu before you start printing.

4.7 Factory settings



Factory settings offer the possibility to reset all parameters that have been changed by the users to the factory settings. The parameters are initialized with the default values. Use the arrow keys <◀>, <▶> to select Y (Yes) or N (No). If you select Y (Yes) and **press** the <Enter> key, the parameter will be initialized. If you select N (No) or press the **ESC key**, the reset will be cancelled.

5. data transmission protocol RS-232

The **SW 1000/2000** sound level meter is equipped with a serial interface RS-232. The user can modify the configuration of the sound level meter via the serial interface and start and stop the sound level meter, request the current measured value parameters and process the results further. The operation via the serial interface does not change the operation via the keyboard.

5.1 Hardware configuration and interface settings

The **SW 1000/2000** device uses a 3-wire serial interface, the physical socket is a 6-pin PS/2 socket. The following is the definition of the RS-232 interface:

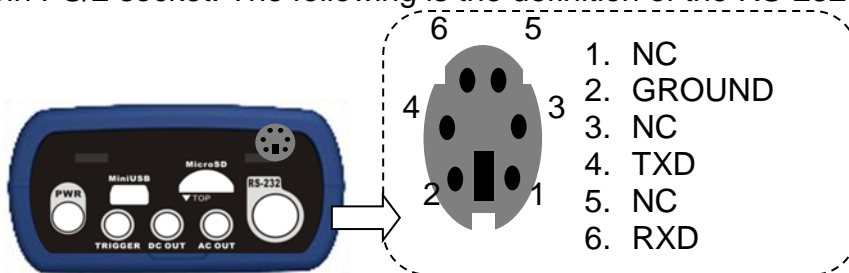

Transmission settings for RS-232:

Transmission mode	Full duplex
Synchronous /asynchronous mode	Asynchronous transmission
Baud rate	4800 bps, 9600 bps, 19200 bps
Data bits	8 bits
Stop bits	1 bit
Parity	None
Data flow control	Observe the time data in the table with the nominal parameters.

5.2 Transmission protocol

The RS-232 interface protocol for **SW 1000/200 is** based on a blockwise transmission according to the following pattern

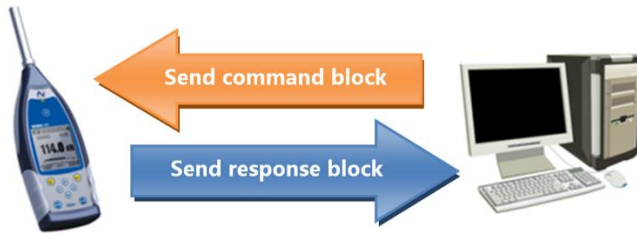

A typical command block or response block consists of a start character, the ID, the attribute character, the command or data, the end character, the block check character, the carriage return and carriage return characters, as shown in the following figure:

<STX>	ID	ATTR	Command or data	<ETX>	BCC	<CR>	<LF>
-------	----	------	-----------------	-------	-----	------	------

5.2.1 Starting and stopping blockwise transmission

A command block or response block contains the start characters, end characters, and other control characters as shown in the following figure

Name	Hex	Meaning
<STX>	02H	Start sign
<ETX>	03H	Stop sign
<CR>	0DH	Carriage returns
<LF>	0AH	Line feed

5.2.2 Device ID

Each command block contains an ID. It is used to distinguish between several sound level meters in a network. When the sound level meter receives a command block, it compares the ID in the command block with its own ID. If both match, the corresponding operation is performed. If not, the command is ignored. The response block returned by the sound level meter also contains the ID indicating who sent the block.

☆Note : Make sure that **the IDs of the sound level meters in the same network are different, otherwise operation will be disturbed!**

The ID is a byte of the binary address. The range is between 1 and 255, the corresponding hexadecimal value is 01H to FFH.

This means that the command is a broadcast command if the ID is contained in the command block 00H. The sound level meter executes the instruction independently of its own ID without data return if the command is a broadcast command.

Name	Hex	Meaning
ID	01H to FFH	Device ID
	00H	Broadcast command

5.2.3 ATTR attribute characters

The ATTR attribute character specifies the type of command or response.

Name	Hex	Meaning
'C'	43H	Command block
'A'	41H	Answer block
<ACK>	06H	Normal response
<NAK>	15H	Error response

5.2.4 BCC (block check character)

The block check character bit in the block is calculated by the sender. The receiver then calculates the BCC value of the block and compares it to the BCC value in the sender block. If both are identical, it follows that the received block is correct. The BCC value is calculated from bytes between <STX> and <ETX> using the XOR operation. When BCC = 00H, the sound level meter does not check the input and directly executes an authorized instruction. In this way, you can simplify the sending of the instruction block; however, this procedure is not recommended for long distance transmissions because BCC is the only way to guarantee the reliability of the data transmission.

Name	Hex	Meaning
BCC	01H to FFH	XOR checksum
	00H	Ignore checksum

5.2.5 Block transmission format

Block transmission of data is possible with four types: as command block, as response block, as normal response block and as error response block. The four instruction format types are described below.

(1) Command block: sent by the computer.

<STX>	ID	ATTR	Instruction	Parameters	<ETX>	BCC	<CR>	<LF>
1	1	1	3	N	1	1	1	1 Byt

Where: ATTR='C'.

All instructions occupy 3 bytes. If more than one parameter is contained, all parameters must be separated by spaces.

(2) Response block: Sent by the sound level meter.

<STX>	ID	ATTR	Answer	<ETX>	BCC	<CR>	<LF>
1	1	1	N	1	1	1	1 Byt

Where: ATTR='A'.

If there is more than one response data, the data must be separated by ", ".

(3) Normal response: Sent by the sound level meter.

<STX>	ID	ATTR	<ETX>	BCC	<CR>	<LF>
1	1	1	1	1	1	1 Byt

Where: ATTR=<ACK>.

(4) Error response: Transmitted by the sound level meter.

<STX>	ID	ATTR	Error code	<ETX>	BCC	<CR>	<LF>
1	1	1	4	1	1	1	1 Byt

Where: ATTR=<NAK>.

The error code occupies 4 bytes. All possible error codes are listed in the following table See section [5.2.6](#) for the meaning of the error codes

Error code	Meaning
0001H	Instruction errors
0002H	Parameter error
0003H	Not available in current status

5.2.6 Recovery after transmission errors

Various errors can occur during transmission of the command block or response block. The following describes how the sound level meter deals with errors and restores the initial state.

(1) Block transfer not completed

Section [5.2.5](#) describes the four formats for block transmission. When the sound level meter detects the beginning of a character block <STX>, it receives the following data until the block end character <CR>, <LF> is received. When data reception is complete and parity is correct, the sound level meter performs follow-up checks. If the character <STX> before <CR>, <LF> is received again, the sound level meter ignores all information received so far and starts receiving a block again.

(2) Validation errors

After receiving the data block, the sound level meter checks the data block (except when BCC = 00H). If the validation fails, the sound level meter ignores this instruction.

(3) Instruction errors

The sound level meter may not recognize the received instruction because the computer sends an undefined instruction or an unexpected error occurred during transmission. If the above mentioned errors occur, the sound level meter returns a NAK block containing error code 0001H.

(4) Parameter error

Parameters in the command block may also be incorrect because parameters are not separated by a space, exceed the available range, or have an incorrect number of arguments. When the above error occurs, the sound level meter returns a NAK block containing the error code 0002H.

(5) Not available in current status

The current status may not work properly in the following cases:

1	When a request to return octave data in level meter mode or a request to return level meter data in octave mode is received,
2	When a calibration request is sent while a measurement is still being performed,
3	When a change of measurement parameters or system parameters is requested while a measurement is being performed.

When the above mentioned error occurs, the sound level meter returns a NAK block containing the error code 0003H.

5.2.7 Data flow control

The sound level meter has a 3-wire serial interface with a 6-pin P/S2 socket, which lacks the contact pins for hardware data flow control. The sound level meter does not support software data flow control. Operation in accordance with the requirements of section [5.2.9 Nominal Parameters](#) can guarantee the correctness of the transmitted and received data.

5.2.8 Operation of several devices

Several sound level meters can be connected to the RS-232 interface, thus creating a measurement network. Users can change the settings of all sound level meters in the same network by broadcast instructions or access the data and parameters of each sound level meter by normal commands.

Note the following:

- (1) In a network, sound level meters must never have the same ID.
- (2) The user may not send a command via broadcast that returns any data.

5.2.9 Nominal parameters

Name	Min.	Nominal value	Max.	Description
Response time of the sound level meter	—	—	2 seconds	If the value is exceeded, processing should work on time overflow.
Time interval of the instruction to send to the sound level meter	—	100 ms	—	—
Waiting time for the sound level meter after receiving <STX>	—	Unlimited	—	This means that the sound level meter will wait forever for the remaining data.
Time interval between each byte that the sound level meter should receive.	—	Unlimited	—	This means that the sending speed of the computer can be very low.

5.3 Instructions

There are two types of instructions: Definition statements and query statements

Adjustment instructions: Define the measurement parameters and system parameters for a sound level meter.

Query commands: Query the parameters and data of the sound level meter.

There are three situations where instructions are sent to the sound level meter: Setting instructions (without response), setting instructions (with response), polling instructions.

(1) Adjustment instructions (no reply):

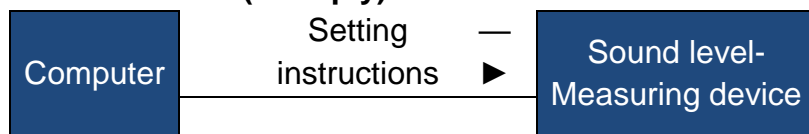

(2) Setting instructions (with reply):

Normal response:

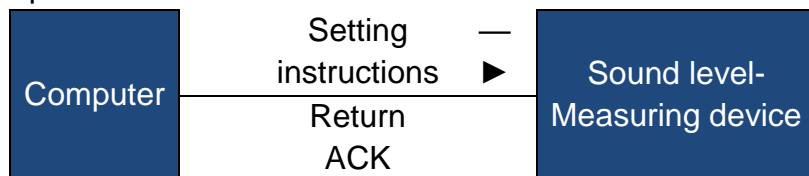

Error response:

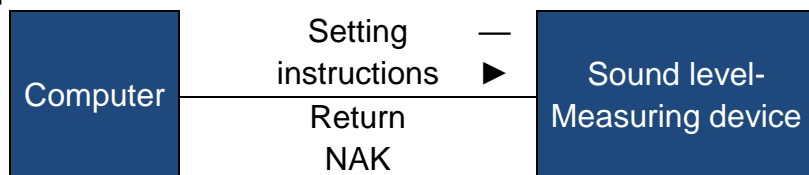

(3) Interrogation command:

Normal response:

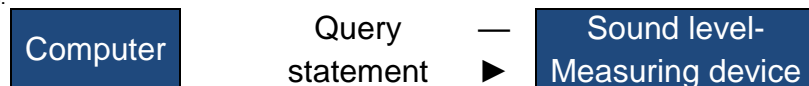

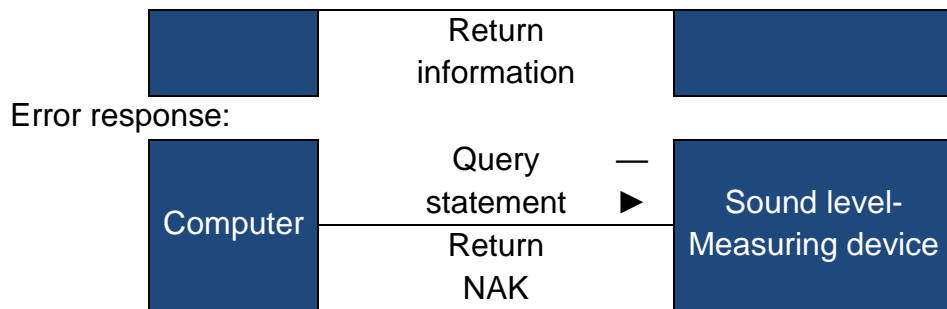

6. operating instructions

6.1 Operation

- Minimize the influence of vibrations when using the sound level meter. Mechanical vibrations can affect the display levels in the lower frequency range of the sound level meter (10 Hz to 20 kHz).
- The sound level meter needs at least 6 hours to adapt to the environment before being switched on. After adapting to the ambient conditions and switching on, a delay time is not necessary before measuring the sound level with the sound level meter.
- The measuring microphone is a sensitive component, handle it with care. Stow the microphone in the supplied box to protect it from external influences.
- Follow the instructions and the user notes. Do not drop the appliance, avoid shaking and impact. Any operation beyond the limits may damage the product.
- Prevent water or other liquids from entering the device, the device is not waterproof.
- The use of high quality alkaline batteries can extend the operating time and be beneficial for the device. Do not use old and new batteries together. Remove the batteries when the device is not in use. If the battery remains in the device for a long time, the battery may leak and damage the device.

6.2 Common problems and solutions

Problem	Possible cause and solution
Device cannot be started.	<ul style="list-style-type: none"> ● Battery exhausted: Replace the battery. ● Power supply failure: Replace the power supply. ● Power switch does not work: Return the device to the factory.
Incorrect measurements:	Try to recalibrate the device.
The measured data does not change noticeably, although the sound source changes significantly.	<ul style="list-style-type: none"> ● Damaged microphone: Return the microphone to the factory. ● Poor contact between microphone and housing: Send the housing to the factory.
button does not work.	Key defective: Send the device to the factory.
Slow reaction during operation	Too many files on the Micro SD card: Delete the damaged files.
The measurement data cannot be stored.	<ul style="list-style-type: none"> ● Check the protocol settings. ● Format the memory card with FAT32. ● Replace the Micro SD memory card with a new one with a maximum capacity of 4 GB.
The printer cannot print the measured data.	<ul style="list-style-type: none"> ● Check the settings for the printer. ● Check that the print paper is loaded correctly.

6.3 Calibration

The sound level meter was calibrated before the sale. Please calibrate the device regularly to maintain the measuring accuracy. BSWA offers a calibration service for acoustic products.

6.4 Firmware Update

The device SW 1000/ SW 2000 can update firmware via the USB connection. The following accessories must be available:

- Sound level meter SW 1000/ SW 2000 (HWID is P0274 and higher) switched off.
- Mini USB cable (included in the package)
- External power supply (included in the package)
- Firmware for the update (can be downloaded from the BSWA website)
- USB driver (driver CP210x from Silicon Labs)

6.4.1 Installing the USB driver

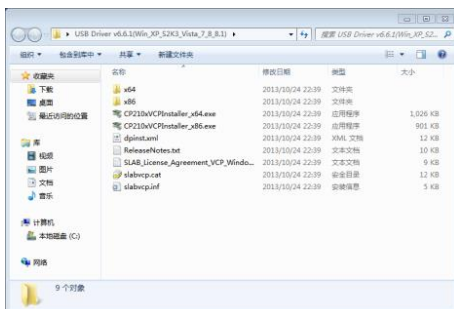

Unpack and install the driver step by step. Select X86 for a 32-bit operating system and X64 for a 64-bit operating system.

☆Note : Do not connect the sound level meter to the computer while installing the driver.

Follow the installation instructions, confirm the license agreement and then click **Next** until the driver installation is complete.

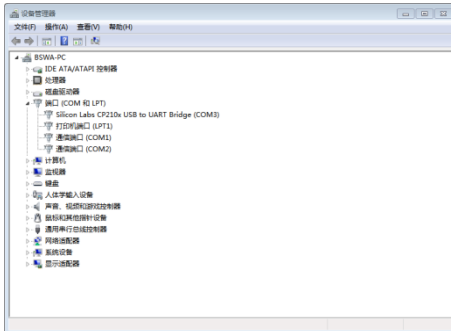

After installing the driver, connect the sound level meter to the computer with a USB cable. In the Device Manager, you will find a new device called **Silicon Labs CP210x USB to UART Bridge (COMx)**.

☆Note : Supply the sound level meter with an external power source when connecting it to the computer.

6.4.2 Firmware update procedure



The firmware update software FlashTool Wizard is particularly user-friendly. Just follow the instructions step by step.

Start the FlashTool Wizard and select the language.



Step 1: Prepare the list for the firmware update.



Step 2: Install the driver. Skip this step if you have already installed the driver.



Step 3: Connect the sound level meter and the computer according to the user's request. Note that the sound level meter requires an external power supply. If the driver is working properly, it will automatically select the CP210x connector. The default value for **baud rate** is 115200 bps, depending on the computer. With a higher **baud rate** the update procedure can be accelerated.

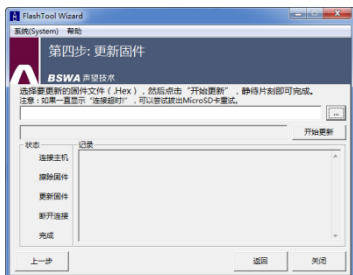

Step 4: First press the button in the upper right corner to select the firmware and then press the **Update** button to start the program. The whole procedure takes 3 to 4 minutes.

☆Note : Reset the device to the factory settings and perform the calibration at least once after the firmware update, otherwise the sound level meter may not work properly. If

the message "Time Out! (time out) message is displayed repeatedly, remove the Micro SD card and try again.

There are no restrictions for upgrading or downgrading the firmware, so the user can update to any version. However, we always recommend to keep the previous version of the firmware. Do not hesitate to contact us by phone or e-mail to request support for problems or bugs of the firmware.

☆Note : A firmware update is a function that is only available for the new sound level meters with HWID: P0274 and higher. The models with the old HWID: P0115 do not support a firmware update by the user. The following is a list of differences between the old and new types:

- **On the About** page, Model P0115 displays as Type 308/200, while Model P0274 displays as Type 308S/200S.
- The RS-232 connector on the P0115 model is a 3-pin Lemo socket, and on the P0274 model, a 6-pin PS/2 socket.
- The USB connection on P0115 does not work, on P0274 it works.
- P0115 has two ranges, "High" and "Low"; some early products also have an automatic range, while model P0274 has only one range.

6.5 Warranty

KERN offers warranty repairs during the warranty period. The component may be replaced at KERN's discretion to eliminate problems caused by material, design or production defects.

For more information, please refer to the product warranty terms in the sales contract. Do not allow the customer to open or repair the device. Attempts to repair by unauthorized persons will void the warranty of this product.

7. Annex

7.1 Corrections for typical reflections from the housing of the sound level meter and sound scattering around the microphone

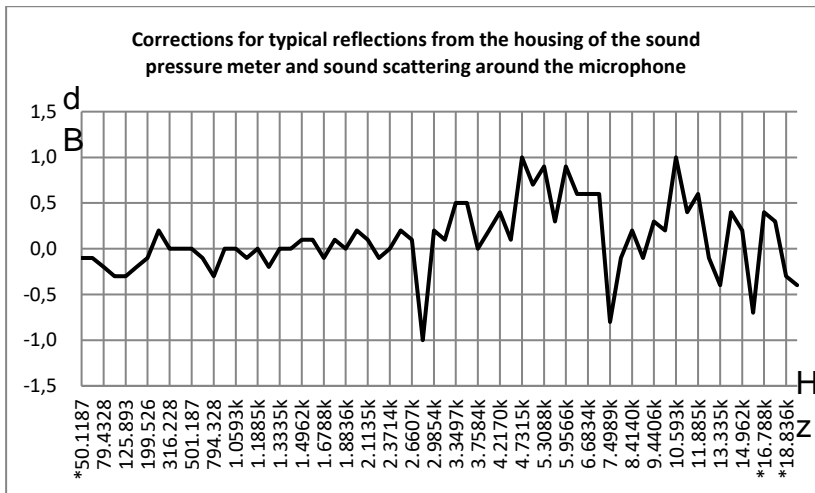

Freq. [Hz]	Value [dB]	Freq. [Hz]	Value [dB]	Freq. [Hz]	Value [dB]	Freq. [Hz]	Value [dB]	Freq. [Hz]	Value [dB]	Freq. [Hz]	Value [dB]
*50,119	-0,1	630,96	-0,1	1678,8	-0,1	3162,3	0,1	5956,6	0,9	11220	0,4
63,096	-0,1	794,33	-0,3	1778,3	0,1	3349,7	0,5	6200,6	0,6	11885	0,6
79,433	-0,2	1000,0	0,0	1883,6	0,0	3548,1	0,5	6683,4	0,6	12589	-0,1
100,00	-0,3	1059,3	0,0	1995,3	0,2	3758,4	0,0	7079,5	0,6	13335	-0,4
125,89	-0,3	1122,0	-0,1	2113,5	0,1	3981,1	0,2	7498,9	-0,8	14125	0,4
158,49	-0,2	1188,5	0,0	2238,7	-0,1	4217,0	0,4	7943,3	-0,1	14962	0,2
199,53	-0,1	1258,9	-0,2	2371,4	0,0	4466,8	0,1	8414,0	0,2	15849	-0,7
251,19	0,2	1333,5	0,0	2.511,9	0,2	4731,5	1,0	8912,5	-0,1	*16788	0,4
316,23	0,0	1412,5	0,0	2660,7	0,1	5011,9	0,7	9440,6	0,3	*17783	0,3
398,11	0,0	1496,2	0,1	2818,4	-1,0	5308,8	0,9	10000	0,2	*18836	-0,3
501,19	0,0	1584,9	0,1	2985,4	0,2	5623,4	0,3	10593	1,0	*19953	-0,4

Extended uncertainties: $U=0.17$ ($k=2$) at ≤ 4 kHz, $U=0.29$ ($k=2$) at > 4 kHz

Note: The frequency marked with * is not prescribed in the standard, the exact frequency can be found in IEC 61672-1.

7.2 Correcting the Draft Shield in the Free Field

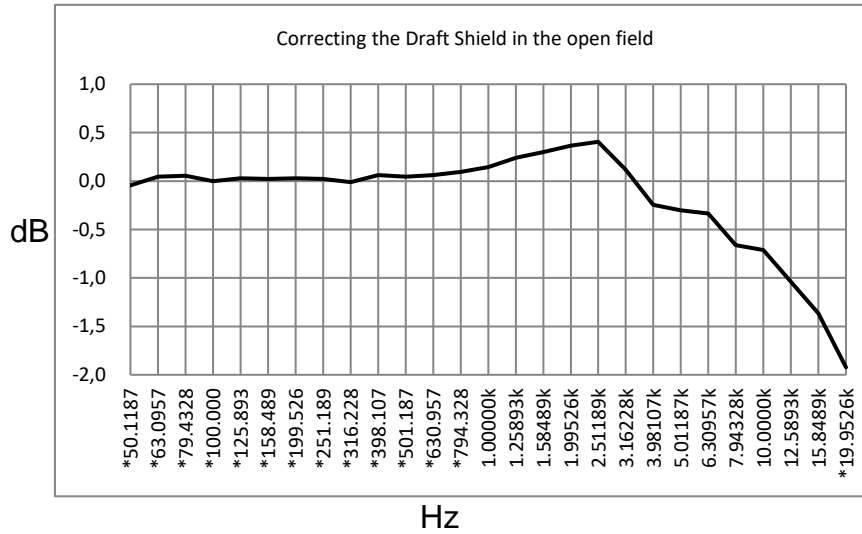

Note: The frequency marked with * is not prescribed in the standard, the exact frequency can be found in IEC 61672-1.

Freq. [Hz]	Value [dB]	Freq. [Hz]	Value [dB]	Freq. [Hz]	Value [dB]
*50,119	-0,04	*398,11	0,06	3162,3	0,12
*63,096	0,04	*501,19	0,04	3981,1	-0,24
*79,433	0,06	*630,96	0,06	5011,9	-0,30
*100,00	0,00	*794,33	0,09	6200,6	-0,33
*125,89	0,03	1000,0	0,14	7943,3	-0,66
*158,49	0,02	1258,9	0,24	10000	-0,71
*199,53	0,03	1584,9	0,30	12589	-1,04
*251,19	0,02	1995,3	0,37	15849	-1,37
*316,23	-0,01	2511,9	0,41	*19953	-1,92

Extended uncertainties: $U=0.15$ ($k=2$) at ≤ 4 kHz, $U=0.21$ ($k=2$) at > 4 kHz.

7.3 Corrections of the electret microphone

The following corrections are measured by the electret microphone and the power supply.

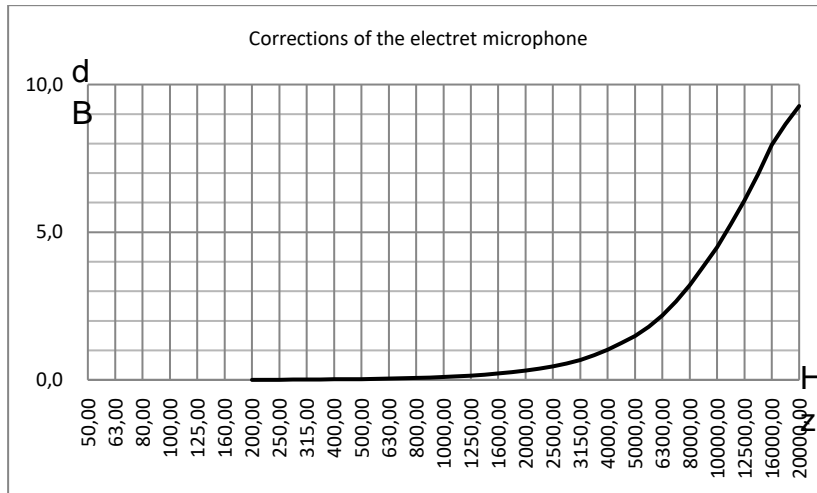

Freq. [Hz]	Value [dB]	Freq. [Hz]	Value [dB]	Freq. [Hz]	Value [dB]	Freq. [Hz]	Value [dB]
200	0,000	630	0,043	2000	0,312	6300	2,184
224	0,002	710	0,053	2240	0,378	7100	2,651
250	0,004	800	0,065	2500	0,456	8000	3,204
280	0,006	900	0,080	2800	0,554	9000	3,840
315	0,009	1000	0,096	3150	0,678	10000	4,488
355	0,013	1120	0,116	3550	0,832	11200	5,264
400	0,017	1250	0,140	4000	1,020	12500	6,081
450	0,022	1400	0,170	4500	1,245	14000	6,960
500	0,027	1600	0,213	5000	1,488	16000	7,956
560	0,034	1800	0,260	5600	1,798	18000	8,664
						20000	9,272

Extended uncertainties: $U=0.19$ ($k=2$) at ≤ 4 kHz, $U=0.34$ ($k=2$) at 4 kHz to 10 kHz, $U=0.39$ ($k=2$) at ≥ 10 kHz.

7.4 Typical frequency response and corresponding upper limit

Each microphone has been carefully tested at the factory before delivery. The calibration diagram in the enclosed box shows the real frequency response of the electret microphone and the frequency response in free field.

The typical frequency response with frequency weighting of the sound level meter is shown in the following figure. The typical frequency response as well as the frequency response of the microphone in the free field can be considered as the overall characteristic of the sound level meter in the free field. The calibration certificate also contains the test results of the frequency response with A, C and Z weighting.

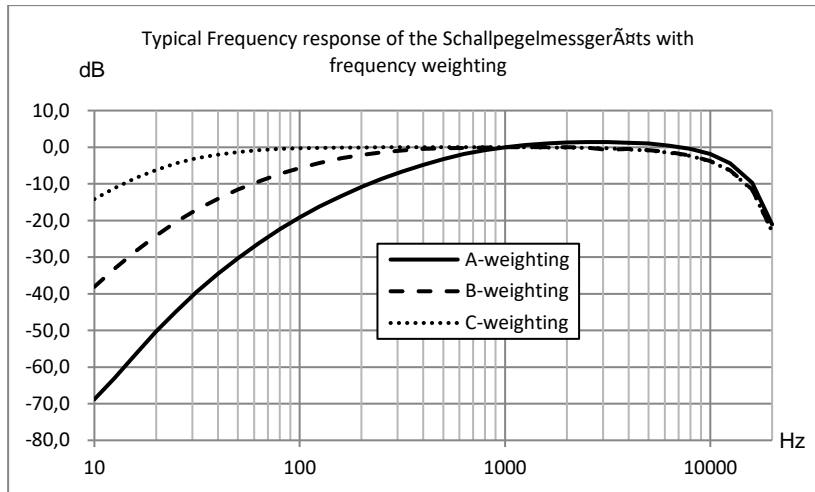

The following table shows the influence of the upper limit of the measuring range with A, B and C weighting and a typical frequency response as shown in the figure:

Freq. [Hz]	31,5	63	125	250	500	1 k	2 k	4 k	8 k	16 k*
A-weighting [dB]	-39,5	-26,2	-16,2	-8,7	-3,3	0,0	+1,3	+1,2	-0,5	-9,7
B-weighting [dB]	-17,1	-9,4	-4,3	-1,4	-0,3	0,0	0,0	-0,5	-2,3	-11,6
C-weighting [dB]	-3,0	-0,8	-0,2	0,0	0,0	0,0	-0,1	-0,6	-2,4	-11,7

Note *: Only available for SW 1000.

7.5 Technical data of the 1/1 octave filter

The 1/1 octave filter was developed from a Butterworth filter with base 10. The technical specifications of each filter are shown in the figure below.

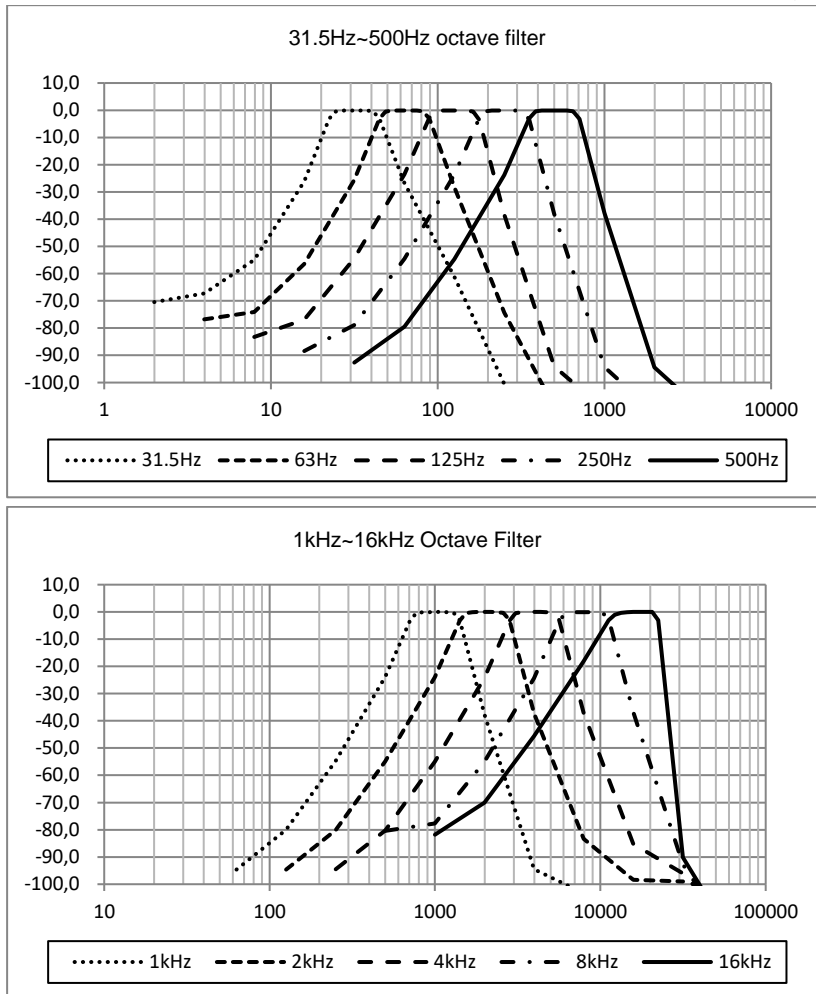

7.6 Glossary

- **Frequency weighting¹:** The difference as a function of frequency between the level of the frequency weighted signal on the display unit and the corresponding level of a constant sinusoidal input signal. The difference in level is expressed in decibels (dB). Frequency weighting usually involves A, B, C and D weighting, which can simulate the frequency response of the human ear. The A and C weighting are more commonly used and are defined in the IEC standard and GB/T standard. The B weighting is only defined in the ANSI standard. The D weighting refers to an international standard that has already been withdrawn. Only some old devices have the D-weighting. No frequency weighting, i.e. a so-called flat characteristic curve is always referred to as Z weighting, flat or linear characteristic curve.
- **Time weighting¹:** Exponential function of time of a certain time constant, which weights the square of a sound pressure signal. The weighting of the sound pressure is higher if it corresponds more strongly to the current time and vice versa. The time weightings "fast" and "slow" are used most often. "Impulse" should not be used and was only provided for historical reasons.
- **SPL:** The sound level SPL calculated in the sound level meter is the largest time-weighted sound level within one second.

- **LEQ**¹: The time average sound level or an equivalent continuous sound level. The 10-fold logarithm to base 10 of the ratio of the square of the average time of a frequency weighted sound pressure signal during a specified time interval and the square of the reference value LEQ is the current integral value of the sound level at the specified duration. The longer the integral period, the slower LEQ changes. LEQ is often used for the overall assessment of noise exposure.
 - **Peak**¹: Peak sound level The 10-fold logarithm to base 10 of the ratio of the square of a frequency weighted peak sound pressure signal to the square of the reference value. This value is usually used to evaluate very short sound pulses.
 - **E**¹: Noise exposure Time integral of the square of a frequency weighted sound pressure signal for a defined time interval or an event of defined duration. This value is always used to evaluate the noise impact on humans.
 - **SEL**¹: Noise exposure The 10-fold logarithm to base 10 of the ratio of a noise exposure to a reference value Sometimes referred to as "single event level".
 - **LN**: Statistical analysis result The noise level that exceeded N % for the measurement period.
 - **Max**¹: Maximum time of weighted sound level within the specified duration
 - **Min**: Minimum time of the weighted sound level within the specified duration.
 - **SD**: Time-weighted sound level of the standard deviation within the specified duration SD is used to describe the degree of variation of the sound level
- Note 1: For further details, see the definition in IEC 61672.1:2013.

Note:

To view the CE declaration, please click on the following link:

<https://www.kern-sohn.com/shop/de/DOWNLOADS/>