

Valde technical specification



.mdd

MDD has a leading position among manufacturers of office furniture with many awards that prove quality and continuously increase demand for its products.

The realities of today's market require constant quality improvement at all levels of modern organization. This applies in particular to customer service, marketing, quality of products and also to quality of processes within the company.

Partnership relations among employees and with business partners form a base of economic growth and success of the company.

Constant investments in innovative machinery park, optimization of management systems and an expansion of production halls allow to minimize the lead times for the product of the highest quality.

More than twenty years of experience in office furniture industry come with reference from a long list of companies and institutions to show their appreciation for an efficient and comprehensive service.

MDD is highly aware of the environment.

Being located in the forest region with lake by its side, MDD takes the nature seriously and invests constantly in a modern and energy-efficient solutions to preserve the local life. Company puts emphasis on waste segregation and recycling. MDD has been awarded for the exceptional care and involvement in waste disposal. All materials used are environmentally friendly and enjoy a high 95 % rate of being recycled.



General informations:

Warranty:

MDD products - **5 years**.

Electrical components and fabric - **2 years**.

Certificate - MFC:



Boards density:

12 mm - 690 - 750 kg/m³

18 mm - 650 - 690 kg/m³

28 mm - 610 - 630 kg/m³

36 mm - 610 - 630 kg/m³

Assembly:

product delivered in separate elements

Packing:

cartboard, bubble wrap,

perforated plastic mesh wrap

Technical specification

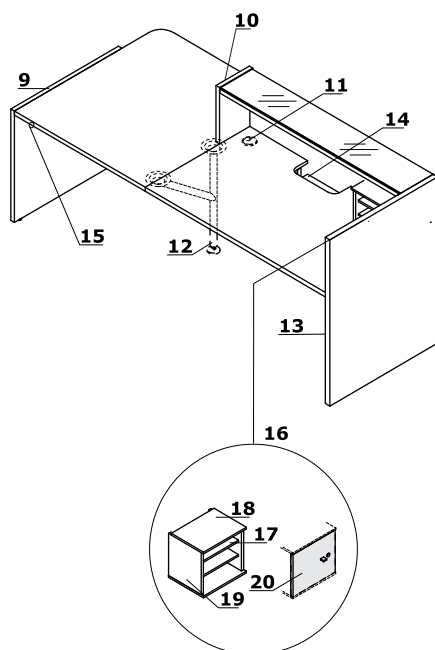
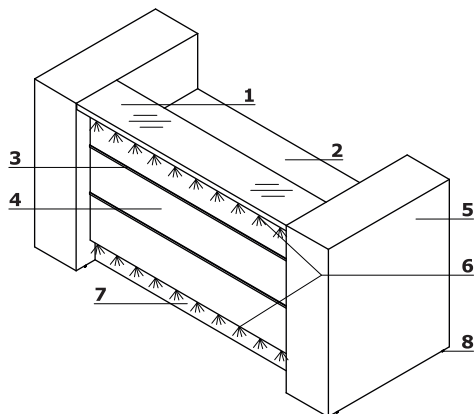

1. **Top** - MFC 36 mm + Glass LACOBEL 4 mm (40 mm)
2. **Worktop** - MFC 28 mm, ABS edge
3. **Decorative stripe** - PVC, colour: M009 - aluminum semi-matt
4. **Front** - HPL 3 mm - high gloss
5. **Storage as ending element** - HPL high gloss 18 mm, ABS edge
6. **LED illumination** - at the full length of the reception desk, cold white color (verging on the blue shade)
7. **Kick plate** - HPL - brushed aluminum
8. **Leveling** - 5 mm range
9. **Low side panel** - all HPL - gloss - 38 mm
10. **Side panel linking low and high fronts** - HPL high gloss - 38 mm
11. **Cable grommets** - Ø80 mm
12. **Supporting leg NE41** - made of metal, required for tops connecting, colours: M015 - white semi-mat, M009 - Aluminum semi-matt, colour adjusted to the colour of worktop
13. **High side panel** - all HPL - gloss - 38 mm
14. **OPTION WITH EXTRA CHARGE** - working top with lowered monitor shelf - MFC 28 mm, ABS edge
15. **Light switch**
16. **LMS05** - reception desk storage; order separately
17. **Shelf** - MFC 18 mm, protection against accidental falling-out, ABS edge
18. **Top** - MFC 12 mm, ABS edge
19. **Body** - MFC 18 mm, ABS edge
20. **Optional front with lock** - universal (left, right) - MFC 18 mm, ABS edge; - ordered as separate element

Ending storage

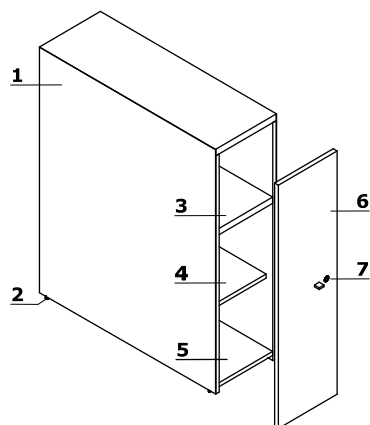

1. **Storage as ending element** - HPL high gloss 18 mm, ABS edge
2. **Leveling** - 5 mm range
3. **Shelf** - MFC 28 mm, ABS edge
4. **Shelf with possibility of height regulation** - MFC 18 mm, ABS edge
5. **Base** - MFC 18 mm, ABS edge
6. **Optional Front LAD10** - MFC 18 mm, universal (left/right), to order as an additional element
7. **Patent lock** - foldable key

Valde	Date of preparation 25.02.2020	The data contained in this document is valid in the day of its preparation. Change of the product, as long as it does not affect the basic features of it, does not require consistent updates of the document.	page 3/11 technical specification
-------	-----------------------------------	---	--------------------------------------

Ending elements application

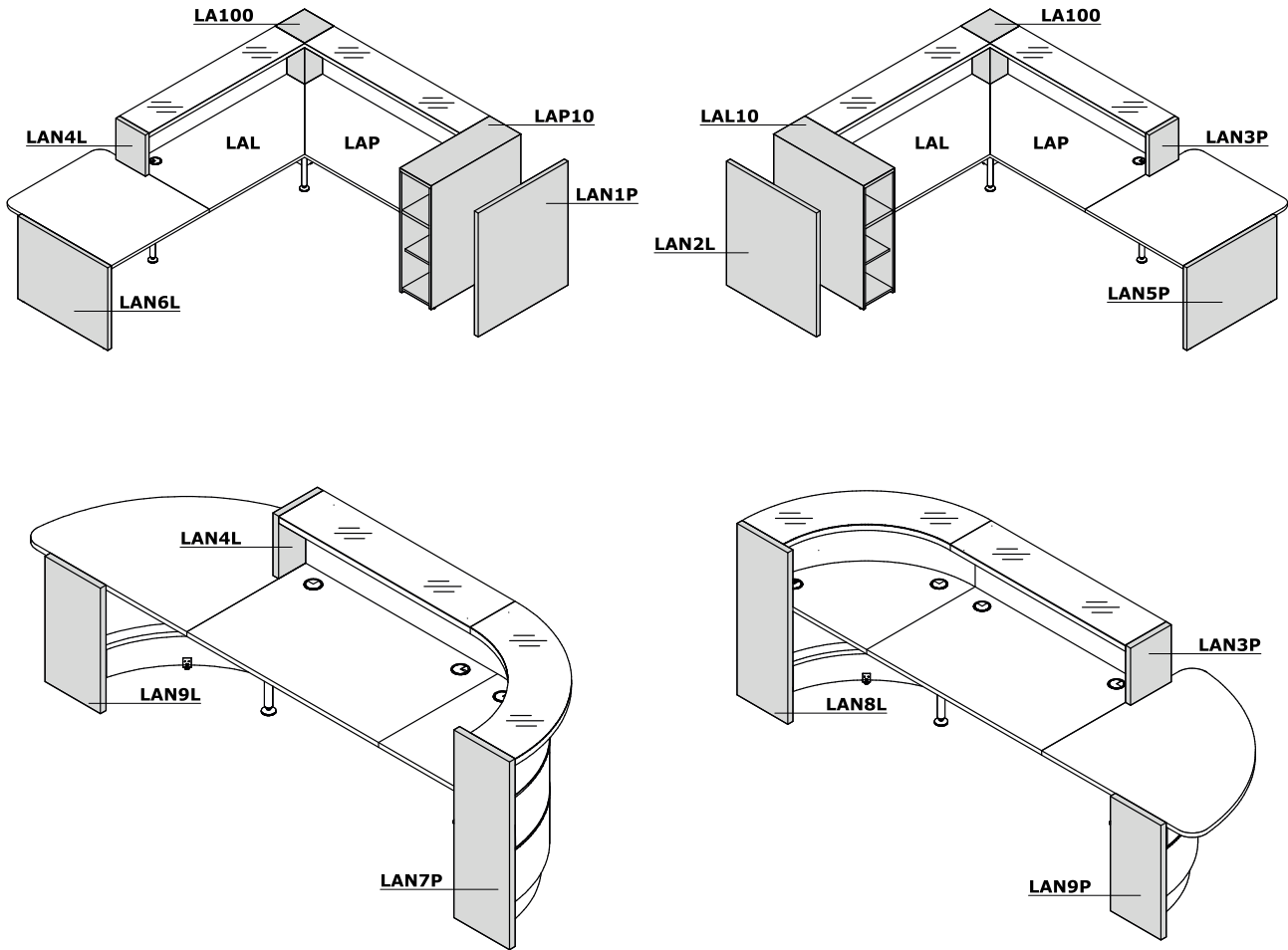

www.mdd.eu

Cargo pedestal

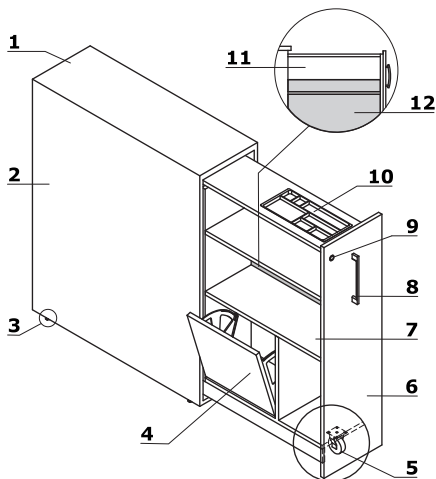

- 1. Top - MFC 28 mm, coated with HPL high gloss
- 2. Body - MFC 18 mm, coated with HPL high gloss
- 3. Leveling - 5 mm range
- 4. Cabinet with flip door - 2 spaces (e.g. for binder, shoes)
- 5. Castors - Ø75 mm
- 6. Front - MFC 18 mm, ABS edge
- 7. Shelf - MFC 18 mm, protection against accidental falling-out, ABS edge
- 8. Aluminum handle
- 9. Patent lock
- 10. Pencil tray - plastic, colour: black
- 11. No back
- 12. Full back rear - MFC 18 mm

<p>Valde</p>	<p>Date of preparation 25.02.2020</p>	<p>The data contained in this document is valid in the day of its preparation. Change of the product, as long as it does not affect the basic features of it, does not require consistent updates of the document.</p>	<p>page 4/11 technical specification</p>
---------------------	---	--	---

Dimensions

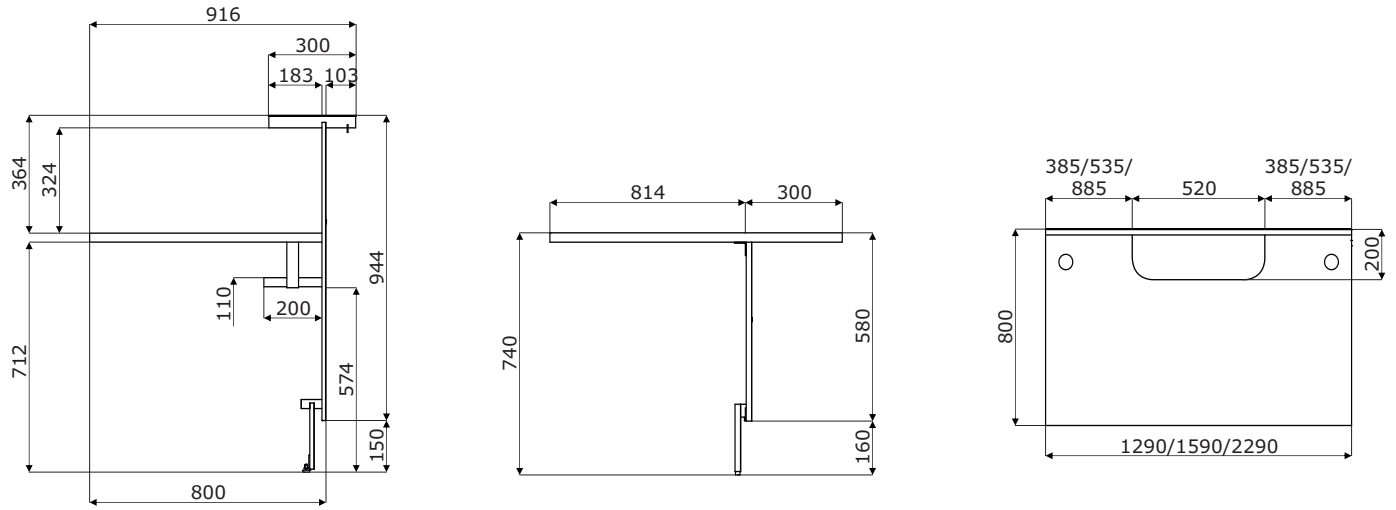

Straight elements *



LA09L
844 / 917 / 1105
36 kg



LA13L
1290 / 917 / 1105
53.6 kg

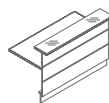
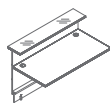

LA16L
1590 / 917 / 1105
67 kg

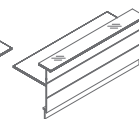

LA23L
2290 / 917 / 1105
93.5 kg



LAP13L
1290 / 917 / 1105
52.6 kg

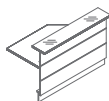
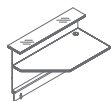

LAP16L
1590 / 917 / 1105
66.5 kg

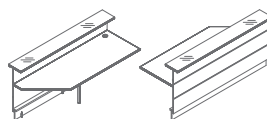

LAP23L
2290 / 917 / 1105
93 kg



LAL13L
1290 / 917 / 1105
52.6 kg

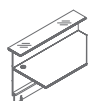

LAL16L
1590 / 917 / 1105
66.5 kg

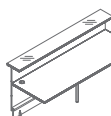

LAL23L
2290 / 917 / 1105
93 kg

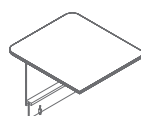

LAU11L
1000 / 1114 / 740
32.5 kg

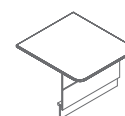

LAU18L
800 / 1114 / 740
28.5 kg

* dimensions expressed in millimeters: width x depth x height

Radial elements *

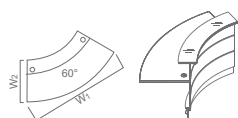

LAV62L
2216 / 917 / 1105
75.5 kg

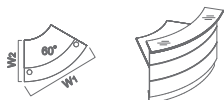

LAV64L
1600 / 917 / 1105
64.5 kg

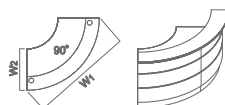

LAV90L
2264 / 917 / 1105
105.5 kg



LAV70L
1297 / 917 / 1105
43.5 kg

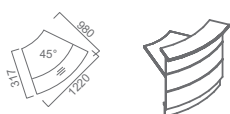

LAV63L
1225 / 917 / 1105
53.5 kg



LAV65L
1311 / 1165 / 740
35.5 kg



LAV66L
1720 / 1109 / 740
54.5 kg



LAV68L
1485 / 1109 / 740
35.5 kg



LA90L
1296 / 616 / 1105
38.2 kg

Composition elements *

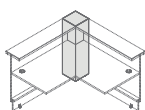

LA100
300 / 300 / 1105
22.2 kg

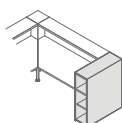

LAP10
318 / 917 / 1105
50 kg

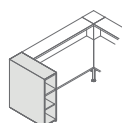

LAL10
318 / 917 / 1105
50 kg

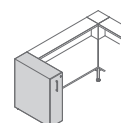

LAC10L
318 / 917 / 1105
70 kg

* dimensions expressed in millimeters: width x depth x height

Composition elements *

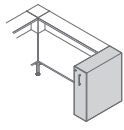

LAC10P
318 / 917 / 1105
70 kg



LAD10
306 / 20 / 1094
4.5 kg

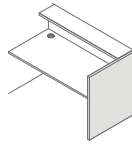

LAN1P
38 / 917 / 1105
26 kg

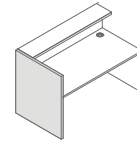

LAN2L
38 / 917 / 1108
26 kg

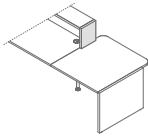

LAN3P
38 / 300 / 364
2.8 kg

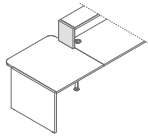

LAN4L
38 / 300 / 364
2.8 kg

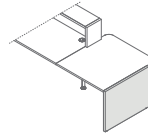

LAN5P
38 / 917 / 740
19 kg

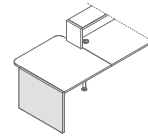

LAN6L
38 / 917 / 740
19 kg

www.mdd.eu

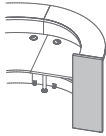

LAN7P
38 / 374 / 1105
11 kg

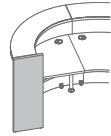

LAN8L
38 / 374 / 1105
11 kg

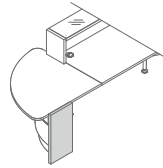

LAN9L
38 / 374 / 740
7.5 kg

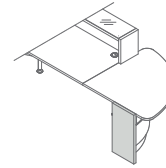

LAN9P
38 / 374 / 740
7.5 kg

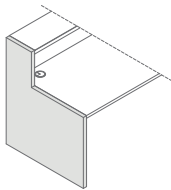

LAN10L
38 / 917 / 1105
26 kg

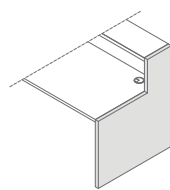

LAN10P
38 / 917 / 1105
26 kg



LMS05
345 / 283 / 314
5 kg

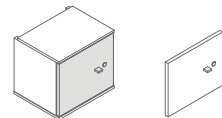

LMS06
339 / 18 / 286
2 kg

* dimensions expressed in millimeters: width x depth x height

Composition elements *



NL41
585 / 142 / 712
2 kg



NE41L
40 / 40 / 712
1.5 kg

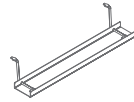

E64L
460 / 89 / 120
0.5 kg

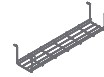

S69L
580 / 162 / 123
1 kg



S81L
140 / 70 / 750
1.1 kg

Sneeze guard *

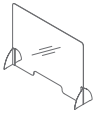

NPX1
1000 / 250 / 750
3 kg

* dimensions expressed in millimeters: width x depth x height

Valde	Date of preparation 25.02.2020	The data contained in this document is valid in the day of its preparation. Change of the product, as long as it does not affect the basic features of it, does not require consistent updates of the document.	page 9/11
			products

Upper top



117 Glass white
RAL9003



Top



67 White pastel



124 Glass silver
RAL9007



26 Aluminum
satinato

Body



67 White pastel

Front



31 Canadian oak



34 Chestnut



73 White high
gloss



74 Orange high
gloss



80 Green high
gloss



81 Burgundy
high gloss



102 Yellow high
gloss



108 Blue high
gloss



127 Dark pink
high gloss



148 Grey high
gloss

Ending elements



73 White high
gloss



148 Grey high
gloss

Supporting legs



M009 Aluminum
semi-matt



M015 White
semi-matt

Copplementary elements LAD10, LMS05, LMS06



26 Aluminum
satinato



67 White pastel

Copplementary elements S69L, E64L



M009 Aluminum
semi-matt RAL9006

Copplementary elements S81L



Grey
